

SMCJ75 Datasheet



<https://www.DiGi-Electronics.com>

DiGi Electronics Part Number	SMCJ75-DG
Manufacturer	Littelfuse Inc.
Manufacturer Product Number	SMCJ75
Description	TVS DIODE 75VWM 127.05VC DO214AB
Detailed Description	127.05V Clamp 12.4A Ipp Tvs Diode Surface Mount DO-214AB (SMCJ)

This model SMCJ75 is available at DiGi Electronics.

DiGi Electronics offers a global database of semiconductor and electronic component datasheets.

We welcome your inquiries regarding pricing, lead time, or other product-related questions.

 [Request a Quote](#)

 [Datasheet Search](#)



Tel: +00 852-30501935

RFQ Email: Info@DiGi-Electronics.com

DiGi is a global authorized distributor of electronic components.

Purchase and inquiry

Manufacturer Product Number:

SMCJ75

Series:

SMCJ

Type:

Zener

Voltage - Reverse Standoff (Typ):

75V

Voltage - Clamping (Max) @ Ipp:

127.05V

Power - Peak Pulse:

1500W (1.5kW)

Applications:

General Purpose

Operating Temperature:

-55°C ~ 150°C (Tj)

Package / Case:

DO-214AB, SMC

Manufacturer:

Littelfuse Inc.

Product Status:

Obsolete

Unidirectional Channels:

1

Voltage - Breakdown (Min):

78.93V

Current - Peak Pulse (10/1000µs):

12.4A

Power Line Protection:

No

Capacitance @ Frequency:

-

Mounting Type:

Surface Mount

Supplier Device Package:

DO-214AB (SMCJ)

Environmental & Export classification

RoHS Status:

ROHS3 Compliant

ECCN:

EAR99

Moisture Sensitivity Level (MSL):

1 (Unlimited)

HTSUS:

8541.10.0080

SMCJ Series

Surface Mount – 1500W



Additional Information



Resources



Accessories



Samples

Agency Approvals

Agency	Agency File Number
	E230531

Maximum Ratings and Thermal Characteristics

($T_A=25^{\circ}\text{C}$ unless otherwise noted)

Parameter	Symbol	Value	Unit
Peak Pulse Power Dissipation(Fig.2) by 10/1000us Test Waveform(Fig.4) (Note 1),(Note 2)-Single Die Parts	P_{PPM}	1500	W
Peak Pulse Power Dissipation(Fig.2) by 10/1000us Test Waveform(Fig.4) (Note 1), (Note 2)-Stacked Die Parts (Note 5)	P_{PPM}	2000	W
Power Dissipation on Infinite Heat Sink at $T_J=50^{\circ}\text{C}$	P_D	6.5	W
Peak Forward Surge Current, 8.3ms Single Half Sine Wave (Note 3)	I_{FSM}	200	A
Maximum Instantaneous Forward Voltage at 100A for Unidirectional Only (Note 4)	V_F	3.5/5.0	V
Operating Temperature Range	T_J	-65 to 150	$^{\circ}\text{C}$
Storage Temperature Range	T_{STG}	-65 to 175	$^{\circ}\text{C}$
Typical Thermal Resistance Junction to Lead	$R_{\theta JL}$	15	$^{\circ}\text{C}/\text{W}$
Typical Thermal Resistance Junction to Ambient	$R_{\theta JA}$	75	$^{\circ}\text{C}/\text{W}$

Notes:

- Non-repetitive current pulse, per Fig. 4 and derated above T_J (initial) = 25°C per Fig. 3.
- Mounted on copper pad area of $0.31 \times 0.31"$ ($8.0 \times 8.0\text{mm}$) to each terminal.
- Measured on 8.3ms single half sine wave or equivalent square wave for unidirectional device only, duty cycle=4 per minute maximum.
- $V_F < 3.5\text{V}$ for single die parts and $V_F < 5.0\text{V}$ for stacked-die parts.
- For stacked die component details, please refer to part numbers labeled by * in Electrical Characteristics.

Description

The SMCJ series is designed specifically to protect sensitive electronic equipment from voltage transients induced by lightning and other transient voltage events.

Features & Benefits

- 1500W peak pulse power capability at 10/1000 μs waveform, repetition rate (duty cycles):0.01%
- Low dynamic resistance
- For surface mounted applications to optimize board space
- Typical failure mode is short from over-specified voltage or current
- Whisker test is conducted based on JEDEC JESD201A per its table 4a and 4c pass class 1 and 2
- IEC 61000-4-2 ESD 30kV(Air), 30kV (Contact)
- Glass passivated chip junction
- $V_{BR} @ T_J = V_{BR} @ 25^{\circ}\text{C} \times (1 + \alpha T \times (T_J - 25))$ (α : Temperature Coefficient, typical value is 0.1%)
- Plastic package is flammability rated V-0 per Underwriters Laboratories
- Halogen free and RoHS compliant
- Pb-free E3 means 2nd level interconnect is Pb-free and the terminal finish material is tin(Sn) (IPC/JEDEC J-STD-609A.01)
- Recognized to UL 497B as an Isolated Loop Circuit Protector
- Products manufactured in the Philippines are available. -Parts with an E suffix are manufactured outside China. (See Ordering and Packaging Options section for details)

Applications

TVS devices are ideal for the protection of I/O Interfaces, VCC bus and other vulnerable circuits used in Telecom, Computer, Industrial and Consumer electronic applications.

Functional Diagram

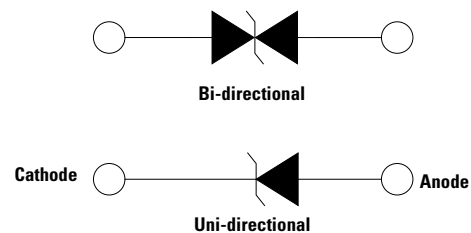

SMCJ Series

Surface Mount – 1500W

Electrical Characteristics ($T_A=25^\circ\text{C}$ unless otherwise noted)

Part Number (Uni)	Part Number (Bi)	Marking		Reverse Stand off Voltage V_R (Volts)	Breakdown Voltage V_{BR} (Volts) @ I_T		Test Current I_T (mA)	Maximum Clamping Voltage V_C @ I_{PP} (V)	Maximum Peak Pulse Current I_{PP} (A)	Maximum Reverse Leakage I_R @ V_R (μA)	Agency Approval 
		UNI	BI		MIN	MAX					
SMCJ5.0A	SMCJ5.0CA	GDE	BDE	5.0	6.40	7.00	10	9.2	163.0	800	X
SMCJ6.0A	SMCJ6.0CA	GDG	BDG	6.0	6.67	7.37	10	10.3	145.7	800	X
SMCJ6.5A	SMCJ6.5CA	GDK	BDK	6.5	7.22	7.98	10	11.2	134.0	500	X
SMCJ7.0A	SMCJ7.0CA	GDM	BDM	7.0	7.78	8.60	10	12.0	125.0	200	X
SMCJ7.5A	SMCJ7.5CA	GDP	BDP	7.5	8.33	9.21	1	12.9	116.3	100	X
SMCJ8.0A	SMCJ8.0CA	GDR	BDR	8.0	8.89	9.83	1	13.6	110.3	50	X
SMCJ8.5A	SMCJ8.5CA	GDT	BDT	8.5	9.44	10.40	1	14.4	104.2	20	X
SMCJ9.0A	SMCJ9.0CA	GDV	BDV	9.0	10.00	11.10	1	15.4	97.4	10	X
SMCJ10A	SMCJ10CA	GDX	BDX	10.0	11.10	12.30	1	17.0	88.3	5	X
SMCJ11A	SMCJ11CA	GDZ	BDZ	11.0	12.20	13.50	1	18.2	82.5	1	X
SMCJ12A	SMCJ12CA	GEE	BEE	12.0	13.30	14.70	1	19.9	75.4	1	X
SMCJ13A	SMCJ13CA	GEG	BEG	13.0	14.40	15.90	1	21.5	69.8	1	X
SMCJ14A	SMCJ14CA	GEK	BEK	14.0	15.60	17.20	1	23.2	64.7	1	X
SMCJ15A	SMCJ15CA	GEM	BEM	15.0	16.70	18.50	1	24.4	61.5	1	X
SMCJ16A	SMCJ16CA	GEP	BEP	16.0	17.80	19.70	1	26.0	57.7	1	X
SMCJ17A	SMCJ17CA	GER	BER	17.0	18.90	20.90	1	27.6	54.4	1	X
SMCJ18A	SMCJ18CA	GET	BET	18.0	20.00	22.10	1	29.2	51.4	1	X
SMCJ20A	SMCJ20CA	GEV	BEV	20.0	22.20	24.50	1	32.4	46.3	1	X
SMCJ22A	SMCJ22CA	GEX	BEX	22.0	24.40	26.90	1	35.5	42.3	1	X
SMCJ24A	SMCJ24CA	GEZ	BEZ	24.0	26.70	29.50	1	38.9	38.6	1	X
SMCJ26A	SMCJ26CA	GFE	BFE	26.0	28.90	31.90	1	42.1	35.7	1	X
SMCJ28A	SMCJ28CA	GFG	BFG	28.0	31.10	34.40	1	45.4	33.1	1	X
SMCJ30A	SMCJ30CA	GFK	BFK	30.0	33.30	36.80	1	48.4	31.0	1	X
SMCJ33A	SMCJ33CA	GFM	BFM	33.0	36.70	40.60	1	53.3	28.2	1	X
SMCJ36A	SMCJ36CA	GFP	BFP	36.0	40.00	44.20	1	58.1	25.9	1	X
SMCJ40A	SMCJ40CA	GFR	BFR	40.0	44.40	49.10	1	64.5	23.3	1	X
SMCJ43A	SMCJ43CA	GFT	BFT	43.0	47.80	52.80	1	69.4	21.7	1	X
SMCJ45A	SMCJ45CA	GFV	BFV	45.0	50.00	55.30	1	72.7	20.6	1	X
SMCJ48A	SMCJ48CA	GFX	BFX	48.0	53.30	58.90	1	77.4	19.4	1	X
SMCJ51A	SMCJ51CA	GFZ	BFZ	51.0	56.70	62.70	1	82.4	18.2	1	X
SMCJ54A	SMCJ54CA	GGE	BGE	54.0	60.00	66.30	1	87.1	17.3	1	X
SMCJ58A	SMCJ58CA	GGG	BGG	58.0	64.40	71.20	1	93.6	16.1	1	X
SMCJ60A	SMCJ60CA	GGK	BGK	60.0	66.70	73.70	1	96.8	15.5	1	X
SMCJ64A	SMCJ64CA	GGM	BGM	64.0	71.10	78.60	1	103.0	14.6	1	X
SMCJ70A	SMCJ70CA	GGP	BGP	70.0	77.80	86.00	1	113.0	13.3	1	X
SMCJ75A	SMCJ75CA	GGR	BGR	75.0	83.30	92.10	1	121.0	12.4	1	X
SMCJ78A	SMCJ78CA	GGT	BGT	78.0	86.70	95.80	1	126.0	11.9	1	X
SMCJ85A	SMCJ85CA	GGV	BGV	85.0	94.40	104.00	1	137.0	11.0	1	X
SMCJ90A	SMCJ90CA	GGX	BGX	90.0	100.00	111.00	1	146.0	10.3	1	X
SMCJ100A	SMCJ100CA	GGZ	BGZ	100.0	111.00	123.00	1	162.0	9.3	1	X
SMCJ110A	SMCJ110CA	GHE	BHE	110.0	122.00	135.00	1	177.0	8.5	1	X
SMCJ120A	SMCJ120CA	GHG	BHG	120.0	133.00	147.00	1	193.0	7.8	1	X
SMCJ130A	SMCJ130CA	GHK	BHK	130.0	144.00	159.00	1	209.0	7.2	1	X
SMCJ150A	SMCJ150CA	GHM	BHM	150.0	167.00	185.00	1	243.0	6.2	1	X
SMCJ160A	SMCJ160CA	GHP	BHP	160.0	178.00	197.00	1	259.0	5.8	1	X
SMCJ170A	SMCJ170CA	GHR	BHR	170.0	189.00	209.00	1	275.0	5.5	1	X
SMCJ180A	SMCJ180CA	GHT	BHT	180.0	201.00	222.00	1	292.0	5.1	1	X
SMCJ200A	SMCJ200CA	GHV	BHV	200.0	224.00	247.00	1	324.0	4.6	1	X
SMCJ220A	SMCJ220CA	GHX	BHX	220.0	246.00	272.00	1	356.0	4.2	1	X
SMCJ250A	SMCJ250CA	GHZ	BHZ	250.0	279.00	309.00	1	405.0	3.7	1	X
SMCJ300A*	SMCJ300CA*	GJE	BJE	300.0	335.00	371.00	1	486.0	4.1	1	X
SMCJ350A*	SMCJ350CA*	GJG	BJG	350.0	391.00	432.00	1	567.0	3.5	1	X
SMCJ400A*	SMCJ400CA*	GJK	BJK	400.0	447.00	494.00	1	648.0	3.0	1	X
SMCJ440A*	SMCJ440CA*	GJM	BJM	440.0	492.00	543.00	1	713.0	2.8	1	X

For bidirectional type having V_R of 10 volts and less, the I_R limit is double. For stack-die parts, use * to label the part number.
For uni-directional 5 V to 250 V, bi-directional 5 V to 250V, add "-E" to the part number for COO Ex-China Site.

SMCJ Series

Surface Mount – 1500W

I-V Curve Characteristics

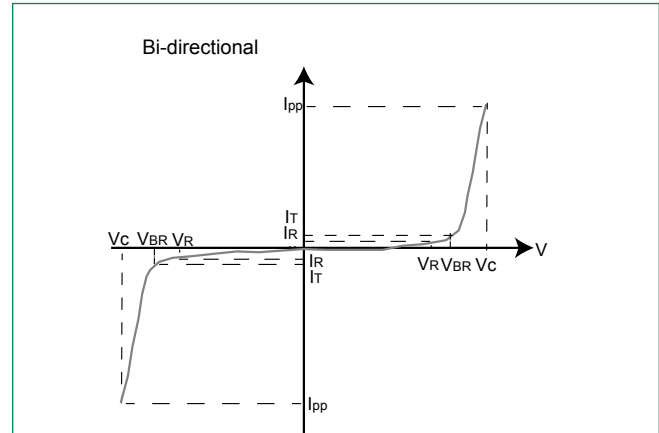
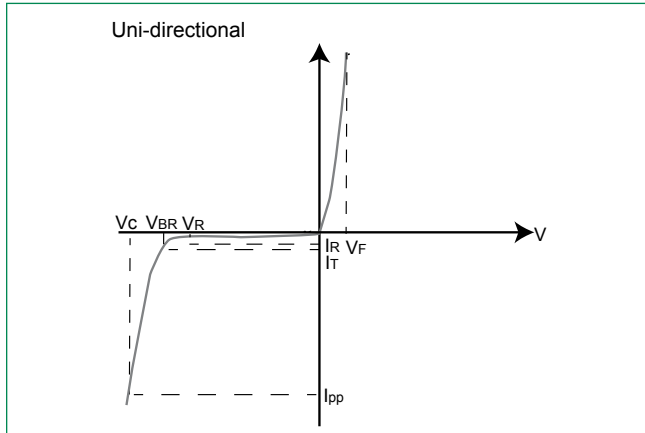

P_{PPM} Peak Pulse Power Dissipation (I_{pp} x V_C) – Max power dissipation

V_R Stand-off Voltage – Maximum voltage that can be applied to the TVS without operation

V_{BR} Breakdown Voltage – Maximum voltage that flows through the TVS at a specified test current (I_T)

V_C Clamping Voltage – Peak voltage measured across the TVS at a specified I_{ppm} (peak impulse current)

I_R Reverse Leakage Current – Current measured at V_R

V_F Forward Voltage Drop for Uni-directional

Ratings and Characteristic Curves (T_A=25°C unless otherwise noted)

Figure 1:
TVS Transients Clamping Waveform

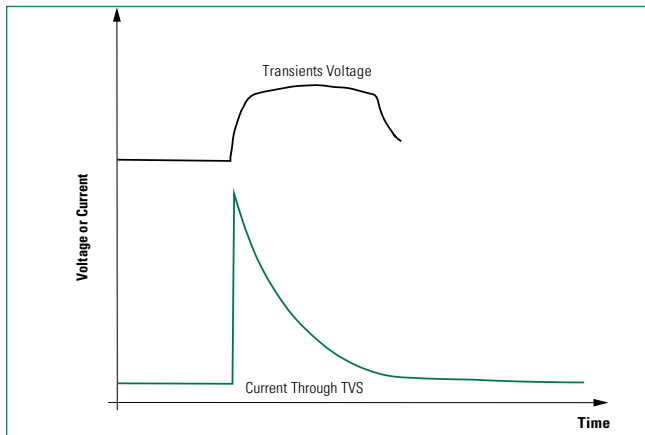
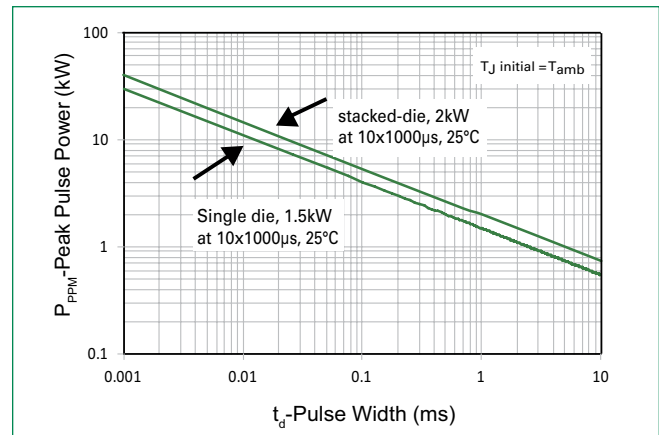

Figure 2:
Peak Pulse Power Rating



SMCJ Series

Surface Mount – 1500W

Ratings and Characteristic Curves ($T_A=25^\circ\text{C}$ unless otherwise noted) (Continued)

Figure 3:
Peak Pulse Power Derating Curve

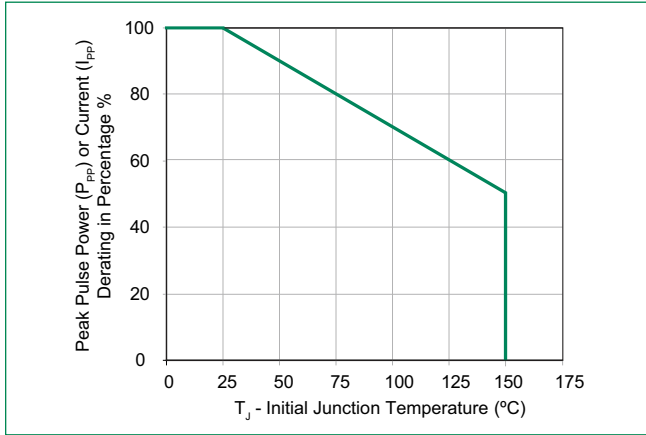

Figure 4:
Pulse Waveform

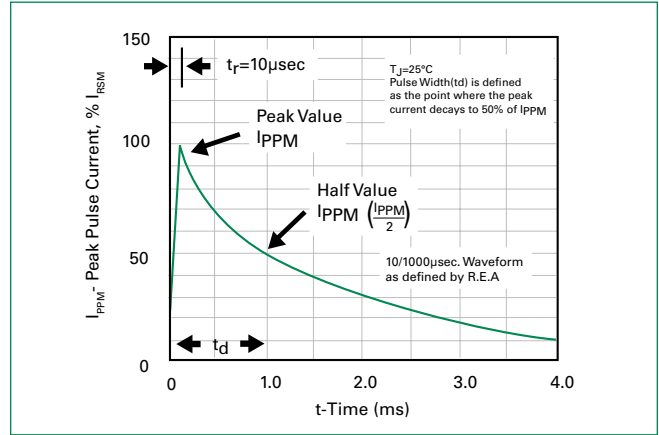

Figure 5:
Typical Junction Capacitance

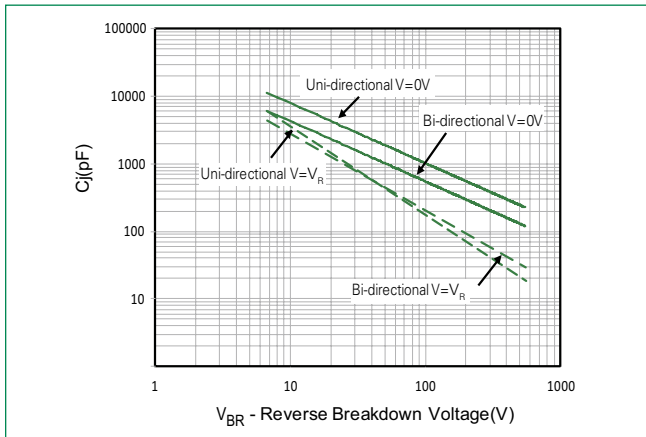

Figure 6:
Maximum Non-Repetitive Peak Forward Surge Current Uni-Directional Only

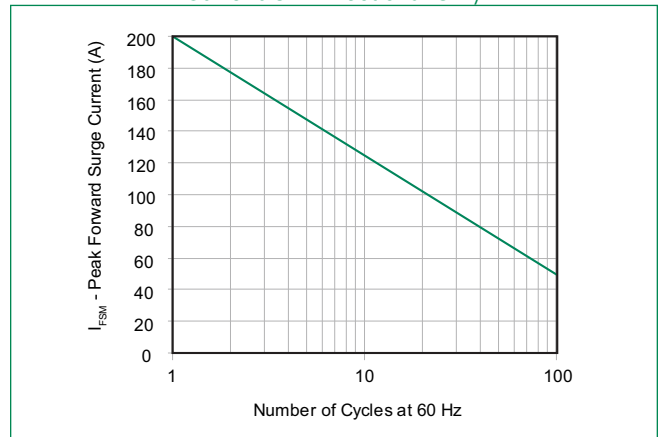
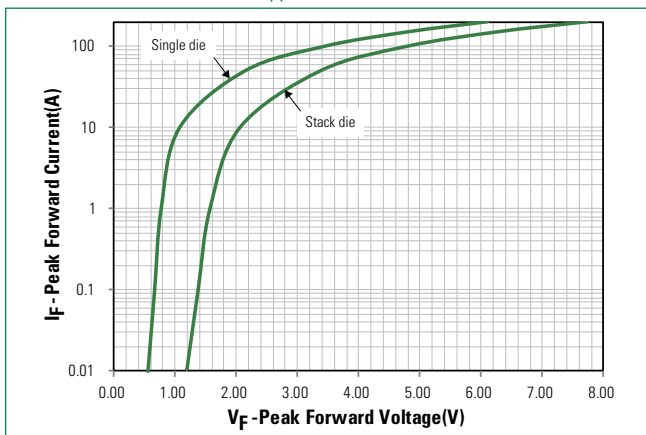

Figure 7:
Peak Forward Voltage Drop vs Peak Forward Current (Typical Values)



SMCJ Series

Surface Mount – 1500W

Soldering Parameters

Reflow Condition		Lead-free assembly
Pre Heat	- Temperature Min ($T_{s(min)}$)	150°C
	- Temperature Max ($T_{s(max)}$)	200°C
	- Time (min to max) (t_s)	60 – 120 secs
Average ramp up rate (Liquidus Temp (T_L) to peak)		3°C/second max
$T_{s(max)}$ to T_L - Ramp-up Rate		3°C/second max
Reflow	- Temperature (T_L) (Liquidus)	217°C
	- Time (min to max) (t_L)	60 – 150 seconds
Peak Temperature (T_p)		260 ^{+0/-5} °C
Time within 5°C of actual peak Temperature (t_p)		30 seconds
Ramp-down Rate		6°C/second max
Time 25°C to peak Temperature (T_p)		8 minutes Max.
Do not exceed		260°C

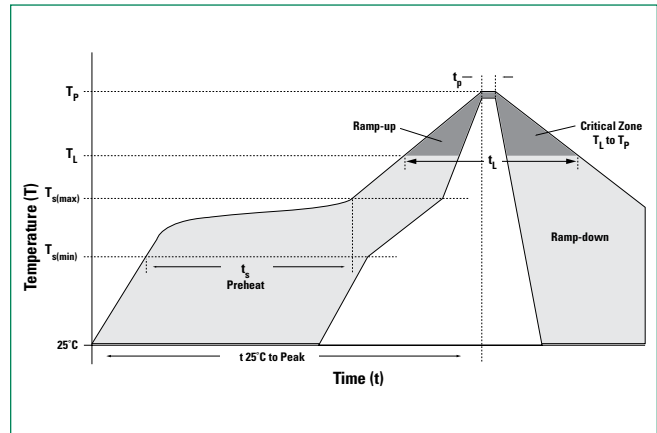

Physical Specifications

Weight	0.007 ounce, 0.21 grams
Case	JEDEC DO214AB. Molded plastic body over glass passivated junction
Polarity	Color band denotes positive end (cathode) except Bidirectional.
Terminal	Matte Tin-plated leads, Solderable per JESD22-B102

Environmental Specifications

High Temp Voltage Blocking (HTRB)	100 % DC reverse voltage rated 150 °C, 1008 hours JEDEC, JESD22-A-108
Biased Temp & Humidity (H3TRB)	80 % breakdown voltage (+85 °C) 85 %RH, 1008 hours JEDEC, JESD22-A-101
Unbiased Highly Accelerated Stress Test (UHASt)	96 hours at TA = 130 °C/85 %RH. JEDEC, JESD22-A-118
Temp Cycling (TC)	-55 °C to +150 °C, 15 min. dwell, 1000 cycles. JEDEC, JESD22-A104
Moisture Sensitivity Level (MSL)	85 %RH, +85 °C, 168 hours, 3 reflow cycles (+260 °C Peak). JEDEC, JEDEC-J-STD-020, Level 1
Resistance to Solder Heat (RSH)	+260 °C, 30 seconds JEDEC, JEDEC JESD22-A-111

DO-214AB (SMC J-Bend)

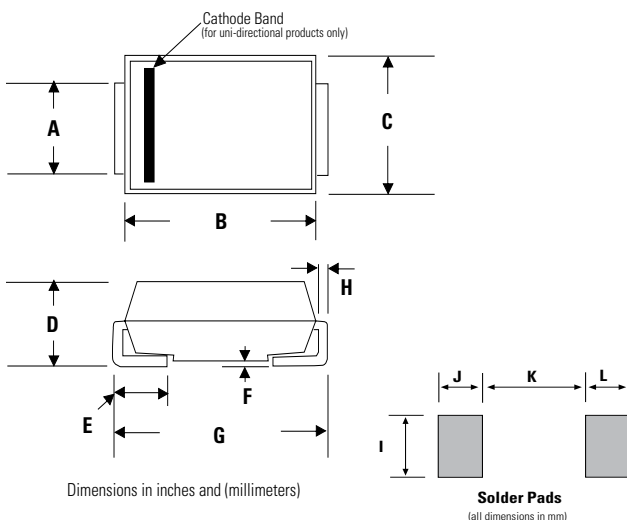

Dimensions

Dimensions	Inches		Millimeters	
	Min	Max	Min	Max
A	0.114	0.126	2.900	3.200
B	0.260	0.280	6.600	7.110
C	0.220	0.245	5.590	6.220
D	0.079	0.103	2.060	2.620
E	0.030	0.060	0.760	1.520
F	-	0.008	-	0.203
G	0.305	0.320	7.750	8.130
H	0.006	0.012	0.152	0.305
I	0.129	-	3.300	-
J	0.094	-	2.400	-
K	-	0.165	-	4.200
L	0.094	-	2.400	-

SMCJ Series

Surface Mount – 1500W

Part Numbering System

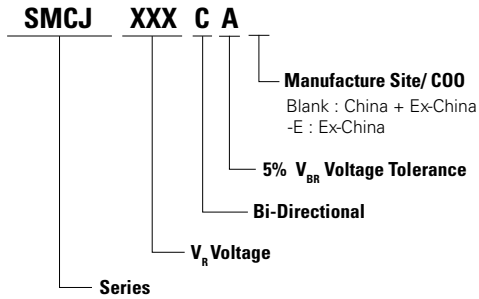

Part Marking System

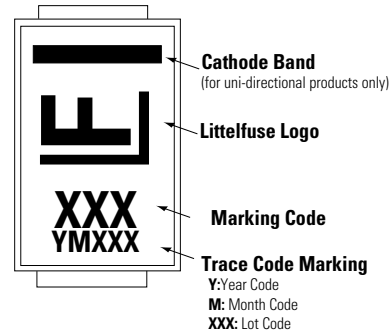

Ordering and Packaging Options

Part number	Component Package	Quantity	Packaging Option	Packaging Specification	Manufacture Site/ COO
SMCJxxxXX	DO-214AB	3000	Tape & Reel - 16mm tape/13" reel	EIA STD RS-481	China + Ex-China
SMCJxxxXX-E ⁽¹⁾⁽²⁾	DO-214AB	3000	Tape & Reel - 16mm tape/13" reel	EIA STD RS-481	Ex-China

Footnote:
 1. Uni-directional product voltage range from 5 V to 250 V
 2. Bi-directional product voltage range from 5 V to 250 V

Tape and Reel Specification

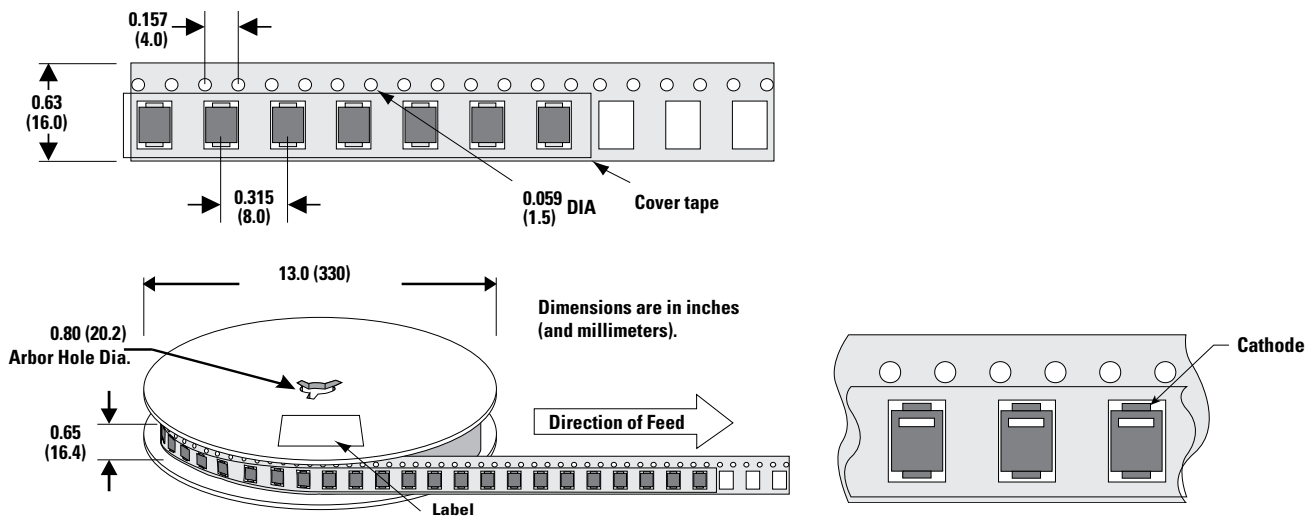

Disclaimer Notice - Information furnished is believed to be accurate and reliable. However, users should independently evaluate the suitability of and test each product selected for their own applications. Littelfuse products are not designed for, and may not be used in, all applications. Read complete Disclaimer Notice at www.littelfuse.com/disclaimer-electronics.

OUR CERTIFICATE

DiGi provide top-quality products and perfect service for customer worldwide through standardization, technological innovation and continuous improvement. DiGi through third-party certification, we stricly control the quality of products and services. Welcome your RFQ to

Email: Info@DiGi-Electronics.com



Tel: +00 852-30501935

RFQ Email: Info@DiGi-Electronics.com

DiGi is a global authorized distributor of electronic components.