

# VBO25-16A02 Datasheet

[www.digi-electronics.com](http://www.digi-electronics.com)



VBO25-16A02

<https://www.DiGi-Electronics.com>

DiGi Electronics Part Number	VBO25-16A02-DG
Manufacturer	IXYS
Manufacturer Product Number	VBO25-16A02
Description	BRIDGE RECT 1P 1.6KV 38A FO-A
Detailed Description	Bridge Rectifier Single Phase Avalanche 1.6 kV QC Terminal FO-A



Tel: +00 852-30501935

RFQ Email: [Info@DiGi-Electronics.com](mailto:Info@DiGi-Electronics.com)

DiGi is a global authorized distributor of electronic components.

## Purchase and inquiry

Manufacturer Product Number:

VBO25-16A02

Series:

-

Diode Type:

Single Phase

Voltage - Peak Reverse (Max):

1.6 kV

Voltage - Forward (Vf) (Max) @ If:

1.36 V @ 55 A

Operating Temperature:

-40°C ~ 150°C (Tj)

Package / Case:

4-Square, FO-A

Base Product Number:

VBO25

Manufacturer:

IXYS

Product Status:

Active

Technology:

Avalanche

Current - Average Rectified (Io):

38 A

Current - Reverse Leakage @ Vr:

300 µA @ 1600 V

Mounting Type:

QC Terminal

Supplier Device Package:

FO-A

## Environmental & Export classification

RoHS Status:

ROHS3 Compliant

REACH Status:

REACH Unaffected

HTSUS:

8541.10.0080

Moisture Sensitivity Level (MSL):

1 (Unlimited)

ECCN:

EAR99

# Single Phase Rectifier Bridge

Standard and Avalanche Types

$$I_{dAV} = 31 \text{ A}$$

$$V_{RRM} = 800-1600 \text{ V}$$

$V_{RSM}$ V	$V_{BRmin}$ ① V	$V_{RRM}$ V	Standard Types	Avalanche Types
900		800	VBO 25-08NO2	
1300	1230	1200	VBO 25-12NO2	VBO 25-12AO2
1700	1630	1600	VBO 25-16NO2	VBO 25-16AO2

① For Avalanche Type only

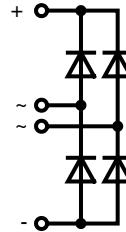

Symbol	Conditions	Maximum Ratings	
$I_{dAV}$ ②	$T_C = 85^\circ\text{C}$ , module	38	A
$I_{dAVM}$	module	40	A
$P_{RSM}$	$T_{VJ} = T_{VJM}$	3.4	kW
$I_{FSM}$	$T_{VJ} = 45^\circ\text{C}$ ; $V_R = 0$	$t = 10 \text{ ms}$ (50 Hz)	370 A
		$t = 8.3 \text{ ms}$ (60 Hz)	390 A
	$T_{VJ} = T_{VJM}$ ; $V_R = 0$	$t = 10 \text{ ms}$ (50 Hz)	320 A
		$t = 8.3 \text{ ms}$ (60 Hz)	340 A
$I^2t$	$T_{VJ} = 45^\circ\text{C}$ ; $V_R = 0$	$t = 10 \text{ ms}$ (50 Hz)	680 A <sup>2</sup> s
		$t = 8.3 \text{ ms}$ (60 Hz)	640 A <sup>2</sup> s
	$T_{VJ} = T_{VJM}$ ; $V_R = 0$	$t = 10 \text{ ms}$ (50 Hz)	510 A <sup>2</sup> s
		$t = 8.3 \text{ ms}$ (60 Hz)	470 A <sup>2</sup> s
$T_{VJ}$		-40...+150	$^\circ\text{C}$
$T_{VJM}$		150	$^\circ\text{C}$
$T_{stg}$		-40...+125	$^\circ\text{C}$
$V_{ISOL}$	50/60 Hz, RMS $I_{ISOL} \leq 1 \text{ mA}$	$t = 1 \text{ min}$	3000 V~
		$t = 1 \text{ s}$	3600 V~
$M_d$	Mounting torque (M5) (10-32 UNF)		1.5-2 Nm
			13-18 lb.in.
Weight	Typ.	15	g

Symbol	Conditions	Characteristic Values	
$I_R$	$V_R = V_{RRM}$ $T_{VJ} = 25^\circ\text{C}$ $T_{VJ} = T_{VJM}$	0.3	mA
		5.0	mA
$V_F$	$I_F = 55 \text{ A}$ $T_{VJ} = 25^\circ\text{C}$	1.36	V
$V_{TO}$	For power-loss calculations only	0.85	V
$r_t$		8	m $\Omega$
$R_{thJC}$	per diode; 120° el.	2.80	K/W
	per module	0.70	K/W
$R_{thJH}$	per diode; 120° el.	3.20	K/W
	per module	0.80	K/W
$d_s$	Creeping distance on surface	13	mm
$d_A$	Creepage distance in air ③	9.5	mm
$a$	Max. allowable acceleration	50	m/s <sup>2</sup>

Data according to IEC 60747 and refer to a single diode unless otherwise stated.

② for resistive load at bridge output

③ with isolated fast-on tabs.

IXYS reserves the right to change limits, test conditions and dimensions.

© IXYS All rights reserved

## Features

- Avalanche rated parts available
- Package with DCB ceramic base plate
- Isolation voltage 3600 V~
- Planar passivated chips
- Low forward voltage drop
- ¼" fast-on terminals
- UL registered E 72873

## Applications

- Supplies for DC power equipment
- Input rectifiers for PWM inverter
- Battery DC power supplies
- Field supply for DC motors

## Advantages

- Easy to mount with one screw
- Space and weight savings
- Improved temperature & power cycling

## Dimensions in mm (1 mm = 0.0394")

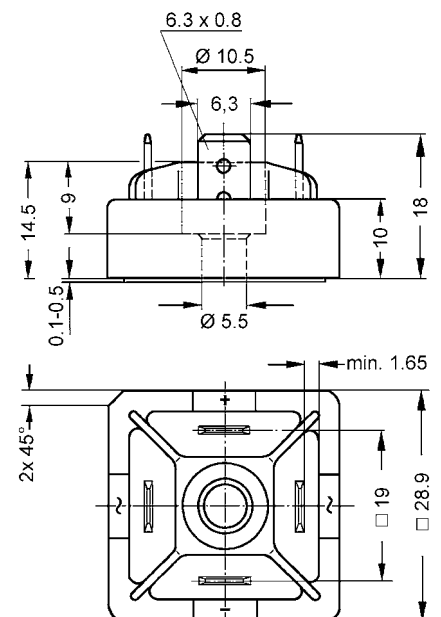

20100706b

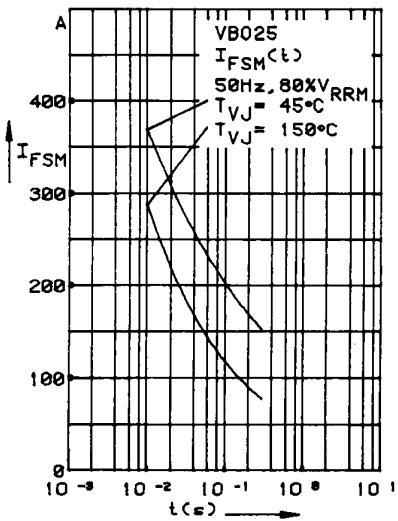

Fig. 1 Surge overload current per diode  
 $I_{FSM}$ : Crest value,  $t$ : duration

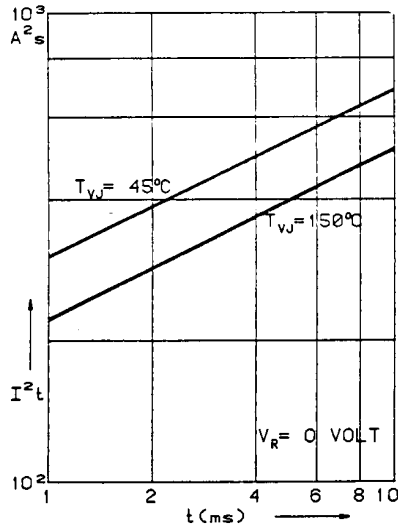

Fig. 2  $I^2t$  versus time (1-10 ms) per diode

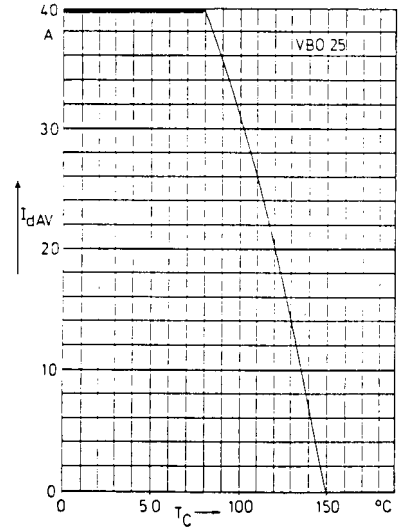

Fig. 3 Max. forward current at case temperature

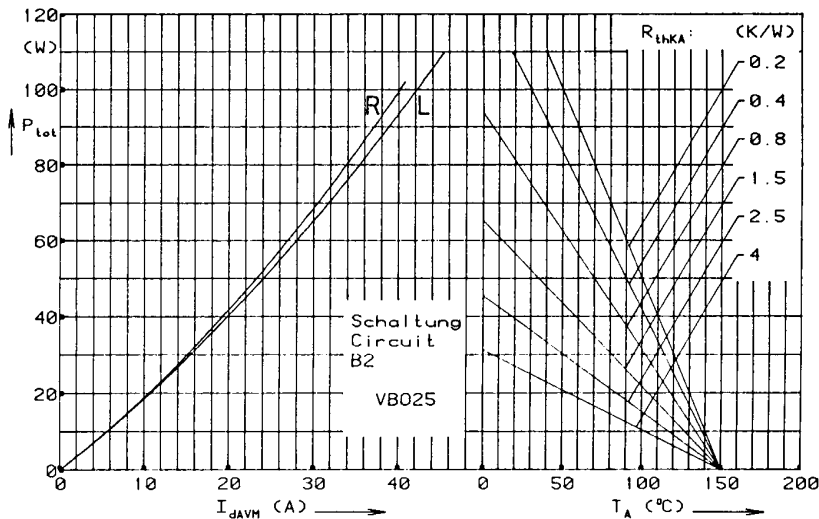

Fig. 4 Power dissipation versus direct output current and ambient temperature

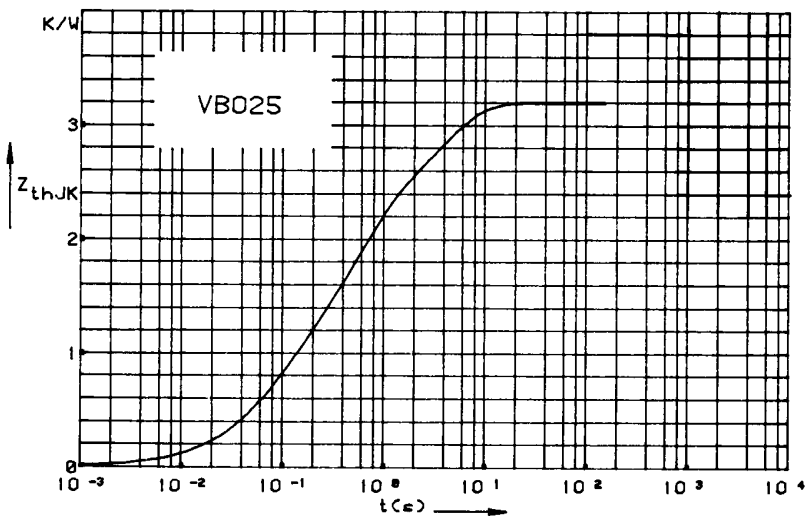

Fig. 5 Transient thermal impedance junction to heatsink per diode

Constants for  $Z_{thJK}$  calculation:

$i$	$R_{thi}$ (K/W)	$t_i$ (s)
1	0.775	0.0788
2	1.390	0.504
3	1.055	3.701

## OUR CERTIFICATE

DiGi provide top-quality products and perfect service for customer worldwide through standardization, technological innovation and continuous improvement. DiGi through third-party certification, we stricly control the quality of products and services. Welcome your RFQ to

Email: [Info@DiGi-Electronics.com](mailto:Info@DiGi-Electronics.com)



Tel: +00 852-30501935

RFQ Email: [Info@DiGi-Electronics.com](mailto:Info@DiGi-Electronics.com)

DiGi is a global authorized distributor of electronic components.