

XCKU085-2FLVA1517I Datasheet



DiGi Electronics Part Number	XCKU085-2FLVA1517I-DG
Manufacturer	AMD
Manufacturer Product Number	XCKU085-2FLVA1517I
Description	IC FPGA 624 I/O 1517FCBGA
Detailed Description	Kintex® UltraScale™ Field Programmable Gate Array (FPGA) IC 624 58265600 1088325 1517-BBGA, FCBGA

<https://www.DiGi-Electronics.com>



Tel: +00 852-30501935

RFQ Email: Info@DiGi-Electronics.com

DiGi is a global authorized distributor of electronic components.

Purchase and inquiry

Manufacturer Product Number:

XCKU085-2FLVA1517I

Series:

Kintex® UltraScale™

DiGi-Electronics Programmable:

Not Verified

Number of Logic Elements/Cells:

1088325

Number of I/O:

624

Mounting Type:

Surface Mount

Package / Case:

1517-BBGA, FCBGA

Base Product Number:

XCKU085

Manufacturer:

AMD

Product Status:

Active

Number of LABs/CLBs:

62190

Total RAM Bits:

58265600

Voltage - Supply:

0.922V ~ 0.979V

Operating Temperature:

-40°C ~ 100°C (TJ)

Supplier Device Package:

1517-FCBGA (40x40)

Environmental & Export classification

RoHS Status:

ROHS3 Compliant

REACH Status:

REACH Unaffected

HTSUS:

8542.39.0001

Moisture Sensitivity Level (MSL):

4 (72 Hours)

ECCN:

3A001A7B



Kintex UltraScale FPGAs Data Sheet: DC and AC Switching Characteristics

DS892 (v1.20) August 20, 2025

Product Specification

Summary

The AMD Kintex™ UltraScale™ FPGAs are available in -3, -2, -1, and -1L speed grades, with -3 having the highest performance. The -1L devices can operate at either of two V_{CCINT} voltages, 0.95V and 0.90V and are screened for lower maximum static power. When operated at $V_{CCINT} = 0.95V$, the speed specification of a -1L device is the same as the -1 speed grade. When operated at $V_{CCINT} = 0.90V$, the -1L performance and static and dynamic power is reduced.

DC and AC characteristics are specified in commercial, extended, industrial, and military temperature ranges. Except the operating temperature range or unless otherwise noted, all the DC and AC electrical parameters are the same for a particular speed grade (that is, the timing characteristics of a -1 speed grade industrial device are the same as for a -1 speed grade commercial device). However, only selected speed grades and/or devices are available in each temperature range.

All supply voltage and junction temperature specifications are representative of worst-case conditions. The parameters included are common to popular designs and typical applications.

This data sheet, part of an overall set of documentation on the UltraScale architecture-based devices, is available on the [AMD Technical Information Portal](#).

DC Characteristics

Table 1: Absolute Maximum Ratings⁽¹⁾

Symbol	Description	Min	Max	Units
FPGA Logic				
V_{CCINT}	Internal supply voltage	-0.500	1.100	V
V_{CCINT_IO} ⁽²⁾	Internal supply voltage for the I/O banks	-0.500	1.100	V
V_{CCAUX}	Auxiliary supply voltage	-0.500	2.000	V
V_{CCBRAM}	Supply voltage for the block RAM memories	-0.500	1.100	V
V_{CCO}	Output drivers supply voltage for HR I/O banks	-0.500	3.400	V
	Output drivers supply voltage for HP I/O banks	-0.500	2.000	V
V_{CCAUX_IO} ⁽³⁾	Auxiliary supply voltage for the I/O banks	-0.500	2.000	V
V_{REF}	Input reference voltage	-0.500	2.000	V

AMD Adaptive Computing is creating an environment where employees, customers, and partners feel welcome and included. To that end, we're removing noninclusive language from our products and related collateral. We've launched an internal initiative to remove language that could exclude people or reinforce historical biases, including terms embedded in our software and IPs. You may still find examples of non-inclusive language in our older products as we work to make these changes and align with evolving industry standards. Follow this [link](#) for more information.

DS892 (v1.20) August 20, 2025

Product Specification

Table 1: Absolute Maximum Ratings⁽¹⁾ (Cont'd)

Symbol	Description	Min	Max	Units
$V_{IN}^{(4)(5)(6)}$	I/O input voltage for HR I/O banks	-0.400	$V_{CCO} + 0.550$	V
	I/O input voltage for HP I/O banks	-0.550	$V_{CCO} + 0.550$	V
	I/O input voltage (when $V_{CCO} = 3.3V$) for V_{REF} and differential I/O standards except TMDS_33 ⁽⁷⁾	-0.400	2.625	V
V_{BATT}	Key memory battery backup supply	-0.500	2.000	V
I_{DC}	Available output current at the pad	-20	20	mA
I_{RMS}	Available RMS output current at the pad	-20	20	mA
GTH and GTY Transceivers				
$V_{MGTAVCC}$	Analog supply voltage for the GTH and GTY transmitter and receiver circuits	-0.500	1.100	V
$V_{MGTAVTT}$	Analog supply voltage for the GTH and GTY transmitter and receiver termination circuits	-0.500	1.320	V
$V_{MGTVCCAUX}$	Auxiliary analog Quad PLL (QPLL) voltage supply for the GTH and GTY transceivers	-0.500	1.935	V
$V_{MGTREFCLK}$	GTH and GTY transceiver reference clocks absolute input voltage	-0.500	1.320	V
$V_{MGTAVTTRCAL}$	Analog supply voltage for the resistor calibration circuit of the GTH and GTY transceiver columns	-0.500	1.320	V
V_{IN}	Receiver (RXP/RXN) and Transmitter (TXP/TXN) absolute input voltage	-0.500	1.260	V
$I_{DCIN-FLOAT}$	DC input current for receiver input pins DC coupled RX termination = floating	-	0 ⁽⁸⁾	mA
$I_{DCIN-MGTAVTT}$	DC input current for receiver input pins DC coupled RX termination = $V_{MGTAVTT}$	-	10	mA
$I_{DCIN-GND}$	DC input current for receiver input pins DC coupled RX termination = GND	-	10	mA
$I_{DCIN-PROG}$	DC input current for receiver input pins DC coupled RX termination = Programmable	-	N/A ⁽⁸⁾	mA
$I_{DCOUT-FLOAT}$	DC output current for transmitter pins DC coupled RX termination = floating	-	0 ⁽⁸⁾	mA
$I_{DCOUT-MGTAVTT}$	DC output current for transmitter pins DC coupled RX termination = $V_{MGTAVTT}$	-	6	mA
System Monitor				
V_{CCADC}	System Monitor supply relative to GNDADC	-0.500	2.000	V
V_{REFP}	System Monitor reference input relative to GNDADC	-0.500	2.000	V
Temperature				
T_{STG}	Storage temperature (ambient)	-65	150	°C
T_{SOL}	Maximum soldering temperature for Pb-free component bodies ⁽⁹⁾	-	260	°C
	Maximum soldering temperature for Pb/Sn component bodies ⁽⁹⁾	-	220	°C

Table 1: Absolute Maximum Ratings⁽¹⁾ (Cont'd)

Symbol	Description	Min	Max	Units
T_j	Maximum junction temperature ⁽⁹⁾	–	125	°C

Notes:

- Stresses beyond those listed under Absolute Maximum Ratings might cause permanent damage to the device. These are stress ratings only, and functional operation of the device at these or any other conditions beyond those listed under Operating Conditions is not implied. Exposure to Absolute Maximum Ratings conditions for extended periods of time might affect device reliability.
- V_{CCINT_IO} must be connected to V_{CCINT} .
- V_{CCAUX_IO} must be connected to V_{CCAUX} .
- The lower absolute voltage specification always applies.
- For I/O operation, see the *UltraScale Architecture SelectIO Resources User Guide* ([UG571](#)).
- The maximum limit applied to DC signals. For maximum undershoot and overshoot AC specifications, see [Table 4](#) and [Table 5](#).
- See [Table 12](#) for TMD5_33 specifications.
- For more information on supported GTH or GTY transceiver terminations see the *UltraScale Architecture GTH Transceiver User Guide* ([UG576](#)) or the *UltraScale Architecture GTY Transceiver User Guide* ([UG578](#)).
- For soldering guidelines and thermal considerations, see the *UltraScale and UltraScale+ FPGAs Packaging and Pinout Specifications* ([UG575](#)).

Table 2: Recommended Operating Conditions⁽¹⁾⁽²⁾

Symbol	Description	Min	Typ	Max	Units
FPGA Logic					
V_{CCINT}	Internal supply voltage	0.922	0.950	0.979	V
	For -1L (0.90V) devices: internal supply voltage	0.880	0.900	0.920	V
	For -3 (1.0V only) devices: internal supply voltage	0.970	1.000	1.030	V
V_{CCINT_IO} ⁽³⁾	Internal supply voltage for the I/O banks	0.922	0.950	0.979	V
	For -1L (0.90V) devices: internal supply voltage for the I/O banks	0.880	0.900	0.920	V
	For -3 (1.0V only) devices: internal supply voltage for the I/O banks	0.970	1.000	1.030	V
V_{CCBRAM}	Block RAM supply voltage	0.922	0.950	0.979	V
	For -3 (1.0V only) devices: block RAM supply voltage	0.970	1.000	1.030	V
V_{CCAUX}	Auxiliary supply voltage	1.746	1.800	1.854	V
V_{CCO} ⁽⁴⁾⁽⁵⁾	Supply voltage for HR I/O banks	1.140	–	3.400	V
	Supply voltage for HP I/O banks	0.950	–	1.890	V
V_{CCAUX_IO} ⁽⁶⁾	Auxiliary I/O supply voltage	1.746	1.800	1.854	V
V_{IN} ⁽⁷⁾	I/O input voltage	–0.200	–	$V_{CCO} + 0.200$	V
	I/O input voltage (when $V_{CCO} = 3.3V$) for V_{REF} and differential I/O standards except TMD5_33 ⁽⁸⁾ .	–	0.400	2.625	V
I_{IN} ⁽⁹⁾	Maximum current through any pin in a powered or unpowered bank when forward biasing the clamp diode.	–	–	10.000	mA
V_{BATT} ⁽¹⁰⁾	Battery voltage	1.000	–	1.890	V
GTH and GTY Transceivers					
$V_{MGTAVCC}$ ⁽¹¹⁾	Analog supply voltage for the GTH and GTY transceivers ⁽¹⁰⁾	0.970	1.000	1.030	V
$V_{MGTAVTT}$ ⁽¹¹⁾	Analog supply voltage for the GTH and GTY transmitter and receiver termination circuits	1.170	1.200	1.230	V
$V_{MGTVCCAUX}$ ⁽¹¹⁾	Auxiliary analog QPLL voltage supply for the transceivers	1.750	1.800	1.850	V
$V_{MGTAVTTRCAL}$ ⁽¹¹⁾	Analog supply voltage for the resistor calibration circuit of the GTH and GTY transceiver columns	1.170	1.200	1.230	V

Table 2: Recommended Operating Conditions⁽¹⁾⁽²⁾ (Cont'd)

Symbol	Description	Min	Typ	Max	Units
SYSMON					
V_{CCADC}	SYSMON supply relative to GNDADC	1.746	1.800	1.854	V
V_{REFP}	Externally supplied reference voltage	1.200	1.250	1.300	V
Temperature					
T_j	Junction temperature operating range for commercial (C) temperature devices	0	–	85	°C
	Junction temperature operating range for extended (E) temperature devices	0	–	100	°C
	Junction temperature operating range for industrial (I) temperature devices	–40	–	100	°C
	Junction temperature operating range for military (M) temperature devices	–55	–	125	°C

Notes:

- All voltages are relative to ground.
- For the design of the power distribution system consult *UltraScale Architecture PCB Design Guide* ([UG583](#)).
- V_{CCINT_IO} must be connected to V_{CCINT} .
- For V_{CCO_0} , the minimum recommended operating voltage for power on and during configuration is 1.425V. After configuration, data is retained even if V_{CCO} drops to 0V.
- Includes V_{CCO} of 1.0V (HP I/O only), 1.2V, 1.35V, 1.5V, 1.8V, 2.5V (HR I/O only) at $\pm 5\%$, and 3.3V (HR I/O only) at $+3/-5\%$.
- V_{CCAUX_IO} must be connected to V_{CCAUX} .
- The lower absolute voltage specification always applies.
- See [Table 12](#) for TMDS_33 specifications.
- A total of 200 mA per 52-pin bank should not be exceeded.
- V_{BATT} is required only when using bitstream encryption. If battery is not used, connect V_{BATT} to either ground or V_{CCAUX} .
- Each voltage listed requires filtering as described in *UltraScale Architecture GTH Transceiver User Guide* ([UG576](#)).



Table 3: DC Characteristics Over Recommended Operating Conditions

Symbol	Description	Min	Typ ⁽¹⁾	Max	Units
V _{DRINT}	Data retention V _{CCINT} voltage (below which configuration data might be lost)	0.82	–	–	V
V _{DRAUX}	Data retention V _{CCAUX} voltage (below which configuration data might be lost)	1.50	–	–	V
I _{REF}	V _{REF} leakage current per pin	–	–	15	μA
I _L	Input or output leakage current per pin (sample-tested)	–	–	15 ⁽²⁾	μA
	Input or output leakage current per pin for XQ devices (sample-tested)	–	–	20 ⁽²⁾	μA
C _{IN} ⁽³⁾	Die input capacitance at the pad (HP I/O)	–	–	3.75	pF
	Die input capacitance at the pad (HR I/O)	–	–	7.00	pF
I _{RPU}	Pad pull-up (when selected) at V _{IN} = 0V, V _{CCO} = 3.3V	75	–	175	μA
	Pad pull-up (when selected) at V _{IN} = 0V, V _{CCO} = 2.5V	50	–	169	μA
	Pad pull-up (when selected) at V _{IN} = 0V, V _{CCO} = 1.8V	60	–	678	μA
	Pad pull-up (when selected) at V _{IN} = 0V, V _{CCO} = 1.5V	30	–	450	μA
	Pad pull-up (when selected) at V _{IN} = 0V, V _{CCO} = 1.2V	10	–	262	μA
I _{RPD}	Pad pull-down (when selected) at V _{IN} = 3.3V	60	–	190	μA
	Pad pull-down (when selected) at V _{IN} = 1.8V	29	–	685	μA
I _{CCADC}	Analog supply current per SYSMON instance in powered up state.	–	–	19.2	mA
I _{BATT} ⁽⁴⁾	Battery supply current	–	–	150	nA
<i>Calibrated programmable on-die termination (DCI) in HP I/O banks⁽⁶⁾ (measured per JEDEC specification)</i>					
R ⁽⁷⁾	Thevenin equivalent resistance of programmable input termination to V _{CCO} /2 where ODT = RTT_40	–10% ⁽⁵⁾	40	+10% ⁽⁵⁾	Ω
	Thevenin equivalent resistance of programmable input termination to V _{CCO} /2 where ODT = RTT_48	–10% ⁽⁵⁾	48	+10% ⁽⁵⁾	Ω
	Thevenin equivalent resistance of programmable input termination to V _{CCO} /2 where ODT = RTT_60	–10% ⁽⁵⁾	60	+10% ⁽⁵⁾	Ω
	Programmable input termination to V _{CCO} where ODT = RTT_40	–10% ⁽⁵⁾	40	+10% ⁽⁵⁾	Ω
	Programmable input termination to V _{CCO} where ODT = RTT_48	–10% ⁽⁵⁾	48	+10% ⁽⁵⁾	Ω
	Programmable input termination to V _{CCO} where ODT = RTT_60	–10% ⁽⁵⁾	60	+10% ⁽⁵⁾	Ω
	Programmable input termination to V _{CCO} where ODT = RTT_120	–10% ⁽⁵⁾	120	+10% ⁽⁵⁾	Ω
	Programmable input termination to V _{CCO} where ODT = RTT_240	–10% ⁽⁵⁾	240	+10% ⁽⁵⁾	Ω



Table 3: DC Characteristics Over Recommended Operating Conditions (Cont'd)

Symbol	Description	Min	Typ ⁽¹⁾	Max	Units
<i>Uncalibrated programmable on-die termination in HP I/Os banks (measured per JEDEC specification)</i>					
R ⁽⁷⁾	Thevenin equivalent resistance of programmable input termination to V _{CC0} /2 where ODT = RTT_40	-50%	40	+50%	Ω
	Thevenin equivalent resistance of programmable input termination to V _{CC0} /2 where ODT = RTT_48	-50%	48	+50%	Ω
	Thevenin equivalent resistance of programmable input termination to V _{CC0} /2 where ODT = RTT_60	-50%	60	+50%	Ω
	Programmable input termination to V _{CC0} where ODT = RTT_40	-50%	40	+50%	Ω
	Programmable input termination to V _{CC0} where ODT = RTT_48	-50%	48	+50%	Ω
	Programmable input termination to V _{CC0} where ODT = RTT_60	-50%	60	+50%	Ω
	Programmable input termination to V _{CC0} where ODT = RTT_120	-50%	120	+50%	Ω
	Programmable input termination to V _{CC0} where ODT = RTT_240	-50%	240	+50%	Ω
<i>Uncalibrated programmable on-die termination in HR I/O banks (measured per JEDEC specification)</i>					
R ⁽⁷⁾	Thevenin equivalent resistance of programmable input termination to V _{CC0} /2 where ODT = RTT_40	-50%	40	+50%	Ω
	Thevenin equivalent resistance of programmable input termination to V _{CC0} /2 where ODT = RTT_48	-50%	48	+50%	Ω
	Thevenin equivalent resistance of programmable input termination to V _{CC0} /2 where ODT = RTT_60	-50%	60	+50%	Ω
Internal V _{REF}	50% V _{CC0}	V _{CC0} × 0.49	V _{CC0} × 0.50	V _{CC0} × 0.51	V
	70% V _{CC0}	V _{CC0} × 0.69	V _{CC0} × 0.70	V _{CC0} × 0.71	V
Differential termination	Programmable differential termination (TERM_100)	–	100	–	Ω
n	Temperature diode ideality factor	–	1.002	–	–
r	Temperature diode series resistance	–	2	–	Ω

Notes:

1. Typical values are specified at nominal voltage, 25°C.
2. For HP I/O banks with a V_{CC0} of 1.8V and separated V_{CC0} and V_{CCAUX_IO} power supplies, the I_L maximum current is 70 μA.
3. This measurement represents the die capacitance at the pad, not including the package.
4. Maximum value specified for worst case process at 25°C. For the XCKU085, XCKU115, and XQKU115 devices, multiply the value by the number of super-logic regions (SLRs) in the device.
5. If VRP resides at a different bank (DCI cascade), the range increases to ±15%.
6. VRP resistor tolerance is (240Ω ±1%)
7. On-die input termination resistance, for more information see the *UltraScale Architecture SelectIO Resources User Guide (UG571)*.

Table 4: V_{IN} Maximum Allowed AC Voltage Overshoot and Undershoot for HR I/O Banks⁽¹⁾⁽²⁾

AC Voltage Overshoot	% of UI at -40°C to 100°C	AC Voltage Undershoot	% of UI at -40°C to 100°C
$V_{CCO} + 0.30$	100%	-0.30	100%
$V_{CCO} + 0.35$	100%	-0.35	70.00%
$V_{CCO} + 0.40$	100%	-0.40	27.00%
$V_{CCO} + 0.45$	100%	-0.45	10.00%
$V_{CCO} + 0.50$	85.00%	-0.50	5.00%
$V_{CCO} + 0.55$	70.00%	-0.55	2.10%
$V_{CCO} + 0.60$	46.60%	-0.60	1.50%
$V_{CCO} + 0.65$	21.20%	-0.65	1.10%
$V_{CCO} + 0.70$	9.75%	-0.70	0.60%
$V_{CCO} + 0.75$	4.55%	-0.75	0.45%
$V_{CCO} + 0.80$	2.15%	-0.80	0.20%
$V_{CCO} + 0.85$	1.00%	-0.85	0.10%
$V_{CCO} + 0.90$	0.50%	-0.90	0.05%
$V_{CCO} + 0.95$	0.25%	-0.95	0.05%

Notes:

1. A total of 200 mA per bank should not be exceeded.
2. For UI smaller than 20 μs .

Table 5: V_{IN} Maximum Allowed AC Voltage Overshoot and Undershoot for HP I/O Banks⁽¹⁾⁽²⁾

AC Voltage Overshoot	% of UI at -40°C to 100°C	AC Voltage Undershoot	% of UI at -40°C to 100°C
$V_{CCO} + 0.05$	100%	-0.05	100%
$V_{CCO} + 0.10$	100%	-0.10	100%
$V_{CCO} + 0.15$	100%	-0.15	100%
$V_{CCO} + 0.20$	100%	-0.20	100%
$V_{CCO} + 0.25$	100%	-0.25	100%
$V_{CCO} + 0.30$	100%	-0.30	100%
$V_{CCO} + 0.35$	92.00%	-0.35	92.00%
$V_{CCO} + 0.40$	70.00%	-0.40	40.00%
$V_{CCO} + 0.45$	30.00%	-0.45	15.00%
$V_{CCO} + 0.50$	15.00%	-0.50	10.00%
$V_{CCO} + 0.55$	10.00%	-0.55	4.00%
$V_{CCO} + 0.60$	8.00%	-0.60	0.00%
$V_{CCO} + 0.65$	6.00%	-0.65	0.00%
$V_{CCO} + 0.70$	4.00%	-0.70	0.00%
$V_{CCO} + 0.75$	2.00%	-0.75	0.00%
$V_{CCO} + 0.80$	2.00%	-0.80	0.00%
$V_{CCO} + 0.85$	2.00%	-0.85	0.00%

Notes:

1. A total of 200 mA per bank should not be exceeded.
2. For UI smaller than 20 μs .



Table 6: Typical Quiescent Supply Current

Symbol	Description	Device	Speed Grade and V_{CCINT} Operating Voltages					Units
			1.0V	0.95V			0.90V	
			-3	-2	-1	-1L	-1L	
I_{CCINTQ}	Quiescent V_{CCINT} supply current	XCKU025	N/A	998	998	N/A	N/A	mA
		XCKU035	1097	998	998	998	907	mA
		XCKU040	1097	998	998	998	907	mA
		XCKU060	1590	1446	1446	1446	1315	mA
		XCKU085	3181	2893	2893	2893	2631	mA
		XCKU095	N/A	2100	2100	N/A	N/A	mA
		XCKU115	3181	2893	2893	2893	2631	mA
		XQKU040	N/A	998	998	N/A	N/A	mA
		XQKU060	N/A	1446	1446	N/A	N/A	mA
		XQKU095	N/A	2100	2100	N/A	N/A	mA
		XQKU115	N/A	2893	2893	N/A	N/A	mA
I_{CCINT_IOQ}	Quiescent current for V_{CCINT_IO} supply	XCKU025	N/A	87	87	N/A	N/A	mA
		XCKU035	98	87	87	87	77	mA
		XCKU040	98	87	87	87	77	mA
		XCKU060	118	105	105	105	93	mA
		XCKU085	236	210	210	210	187	mA
		XCKU095	N/A	143	143	N/A	N/A	mA
		XCKU115	236	210	210	210	187	mA
		XQKU040	N/A	87	87	N/A	N/A	mA
		XQKU060	N/A	105	105	N/A	N/A	mA
		XQKU095	N/A	143	143	N/A	N/A	mA
		XQKU115	N/A	210	210	N/A	N/A	mA
I_{CCOQ}	Quiescent V_{CCO} supply current	XCKU025	N/A	1	1	N/A	N/A	mA
		XCKU035	1	1	1	1	1	mA
		XCKU040	1	1	1	1	1	mA
		XCKU060	1	1	1	1	1	mA
		XCKU085	1	1	1	1	1	mA
		XCKU095	N/A	1	1	N/A	N/A	mA
		XCKU115	1	1	1	1	1	mA
		XQKU040	N/A	1	1	N/A	N/A	mA
		XQKU060	N/A	1	1	N/A	N/A	mA
		XQKU095	N/A	1	1	N/A	N/A	mA
		XQKU115	N/A	1	1	N/A	N/A	mA



Table 6: Typical Quiescent Supply Current (Cont'd)

Symbol	Description	Device	Speed Grade and V _{CCINT} Operating Voltages					Units
			1.0V	0.95V			0.90V	
			-3	-2	-1	-1L	-1L	
I _{CCAUXQ}	Quiescent V _{CCAUX} supply current	XCKU025	N/A	145	145	N/A	N/A	mA
		XCKU035	145	145	145	145	145	mA
		XCKU040	145	145	145	145	145	mA
		XCKU060	188	188	188	188	188	mA
		XCKU085	376	376	376	376	376	mA
		XCKU095	N/A	273	273	N/A	N/A	mA
		XCKU115	376	376	376	376	376	mA
		XQKU040	N/A	145	145	N/A	N/A	mA
		XQKU060	N/A	188	188	N/A	N/A	mA
		XQKU095	N/A	273	273	N/A	N/A	mA
		XQKU115	N/A	376	376	N/A	N/A	mA
I _{CCAUX_IOQ}	Quiescent V _{CCAUX_IO} supply current	XCKU025	N/A	66	66	N/A	N/A	mA
		XCKU035	66	66	66	66	66	mA
		XCKU040	66	66	66	66	66	mA
		XCKU060	83	83	83	83	83	mA
		XCKU085	165	165	165	165	165	mA
		XCKU095	N/A	124	124	N/A	N/A	mA
		XCKU115	165	165	165	165	165	mA
		XQKU040	N/A	66	66	N/A	N/A	mA
		XQKU060	N/A	83	83	N/A	N/A	mA
		XQKU095	N/A	124	124	N/A	N/A	mA
		XQKU115	N/A	165	165	N/A	N/A	mA
I _{CCBRAMQ}	Quiescent V _{CCBRAM} supply current	XCKU025	N/A	39	39	N/A	N/A	mA
		XCKU035	42	39	39	39	39	mA
		XCKU040	42	39	39	39	39	mA
		XCKU060	76	69	69	69	69	mA
		XCKU085	153	139	139	139	139	mA
		XCKU095	N/A	111	111	N/A	N/A	mA
		XCKU115	153	139	139	139	139	mA
		XQKU040	N/A	39	39	N/A	N/A	mA
		XQKU060	N/A	69	69	N/A	N/A	mA
		XQKU095	N/A	111	111	N/A	N/A	mA
		XQKU115	N/A	139	139	N/A	N/A	mA

Notes:

1. Typical values are specified at nominal voltage, 85°C junction temperatures (T_j) with single-ended SelectIO™ resources.
2. Typical values are for blank configured devices with no output current loads, no active input pull-up resistors, all I/O pins are 3-state and floating.
3. Use the AMD Power Estimator (XPE) spreadsheet tool (download at www.xilinx.com/power) to estimate static power consumption for conditions other than those specified.



Power-On/Off Power Supply Sequencing

The recommended power-on sequence is V_{CCINT}/V_{CCINT_IO} , V_{CCBRAM} , V_{CCAUX}/V_{CCAUX_IO} , and V_{CCO} to achieve minimum current draw and ensure that the I/Os are 3-stated at power-on. The recommended power-off sequence is the reverse of the power-on sequence. If V_{CCINT}/V_{CCINT_IO} and V_{CCBRAM} have the same recommended voltage levels, they can be powered by the same supply and ramped simultaneously. V_{CCINT_IO} must be connected to V_{CCINT} . If V_{CCAUX}/V_{CCAUX_IO} and V_{CCO} have the same recommended voltage levels, they can be powered by the same supply and ramped simultaneously. V_{CCAUX} and V_{CCAUX_IO} must be connected together. When the current minimums are met, the device powers on after the V_{CCINT}/V_{CCINT_IO} , V_{CCBRAM} , V_{CCAUX}/V_{CCAUX_IO} , and V_{CCO} supplies have all passed through their power-on reset threshold voltages. The device must not be configured until after V_{CCINT} is applied.

V_{CCADC} and V_{REF} can be powered at any time and have no power-up sequencing recommendations.

The recommended power-on sequence to achieve minimum current draw for the GTH or GTY transceivers is V_{CCINT} , $V_{MGTAVCC}$, $V_{MGTAVTT}$ OR $V_{MGTAVCC}$, V_{CCINT} , $V_{MGTAVTT}$. There is no recommended sequencing for $V_{MGTVCCAUX}$. Both $V_{MGTAVCC}$ and V_{CCINT} can be ramped simultaneously. The recommended power-off sequence is the reverse of the power-on sequence to achieve minimum current draw. If these recommended sequences are not met, current drawn from $V_{MGTAVTT}$ can be higher than specifications during power-up and power-down.



Table 7 shows the minimum current, in addition to I_{CCQ} , that are required by Kintex UltraScale FPGAs for proper power-on and configuration. If the current minimums shown in Table 6 and Table 7 are met, the device powers on after all four supplies have passed through their power-on reset threshold voltages. The device must not be configured until after V_{CCINT} is applied. Once initialized and configured, use the AMD Power Estimator (XPE) tools to estimate current drain on these supplies.

Table 7: Power-on Current by Device

Device	$I_{CCINTMIN} + I_{CCINT_IOMIN}$	I_{CCO}	$I_{CCAUXMIN} + I_{CCAUX_IOMIN}$	$I_{CCBRAMMIN}$	Units
XCKU025	$I_{CCINTQ} + I_{CCINT_IOQ} + 2400$	$I_{CCO_OQ} + 100$	$I_{CCAUXQ} + I_{CCAUX_IOQ} + 380$	$I_{CCBRAMQ} + 50$	mA
XCKU035	$I_{CCINTQ} + I_{CCINT_IOQ} + 2400$	$I_{CCO_OQ} + 100$	$I_{CCAUXQ} + I_{CCAUX_IOQ} + 380$	$I_{CCBRAMQ} + 50$	mA
XCKU040	$I_{CCINTQ} + I_{CCINT_IOQ} + 2400$	$I_{CCO_OQ} + 100$	$I_{CCAUXQ} + I_{CCAUX_IOQ} + 380$	$I_{CCBRAMQ} + 50$	mA
XCKU060	$I_{CCINTQ} + I_{CCINT_IOQ} + 3284$	$I_{CCO_OQ} + 137$	$I_{CCAUXQ} + I_{CCAUX_IOQ} + 520$	$I_{CCBRAMQ} + 100$	mA
XCKU085	$I_{CCINTQ} + I_{CCINT_IOQ} + 6568$	$I_{CCO_OQ} + 274$	$I_{CCAUXQ} + I_{CCAUX_IOQ} + 1040$	$I_{CCBRAMQ} + 137$	mA
XCKU095	$I_{CCINTQ} + I_{CCINT_IOQ} + 3300$	$I_{CCO_OQ} + 40$	$I_{CCAUXQ} + I_{CCAUX_IOQ} + 400$	$I_{CCBRAMQ} + 150$	mA
XCKU115	$I_{CCINTQ} + I_{CCINT_IOQ} + 6568$	$I_{CCO_OQ} + 274$	$I_{CCAUXQ} + I_{CCAUX_IOQ} + 1040$	$I_{CCBRAMQ} + 137$	mA
XQKU040	$I_{CCINTQ} + I_{CCINT_IOQ} + 2400$	$I_{CCO_OQ} + 100$	$I_{CCAUXQ} + I_{CCAUX_IOQ} + 380$	$I_{CCBRAMQ} + 50$	mA
XQKU060	$I_{CCINTQ} + I_{CCINT_IOQ} + 3284$	$I_{CCO_OQ} + 137$	$I_{CCAUXQ} + I_{CCAUX_IOQ} + 520$	$I_{CCBRAMQ} + 100$	mA
XQKU095	$I_{CCINTQ} + I_{CCINT_IOQ} + 3300$	$I_{CCO_OQ} + 40$	$I_{CCAUXQ} + I_{CCAUX_IOQ} + 400$	$I_{CCBRAMQ} + 150$	mA
XQKU115	$I_{CCINTQ} + I_{CCINT_IOQ} + 6568$	$I_{CCO_OQ} + 274$	$I_{CCAUXQ} + I_{CCAUX_IOQ} + 1040$	$I_{CCBRAMQ} + 137$	mA

Table 8 shows the power supply ramp time.

Table 8: Power Supply Ramp Time

Symbol	Description	Min	Max	Units
T_{VCCINT}	Ramp time from GND to 95% of V_{CCINT}	0.2	40	ms
T_{VCCINT_IO}	Ramp time from GND to 95% of V_{CCINT_IO}	0.2	40	ms
T_{VCCO}	Ramp time from GND to 95% of V_{CCO}	0.2	40	ms
T_{VCCAUX}	Ramp time from GND to 95% of V_{CCAUX}	0.2	40	ms
$T_{VCCBRAM}$	Ramp time from GND to 95% of V_{CCBRAM}	0.2	40	ms
$T_{MGTAVCC}$	Ramp time from GND to 95% of $V_{MGTAVCC}$	0.2	40	ms
$T_{MGTAVTT}$	Ramp time from GND to 95% of $V_{MGTAVTT}$	0.2	40	ms
$T_{MGTVCCAUX}$	Ramp time from GND to 95% of $V_{MGTVCCAUX}$	0.2	40	ms



DC Input and Output Levels

Values for V_{IL} and V_{IH} are recommended input voltages. Values for I_{OL} and I_{OH} are guaranteed over the recommended operating conditions at the V_{OL} and V_{OH} test points. Only selected standards are tested. These are chosen to ensure that all standards meet their specifications. The selected standards are tested at a minimum V_{CCO} with the respective V_{OL} and V_{OH} voltage levels shown. Other standards are sample tested.

Table 9: SelectIO DC Input and Output Levels For HR I/O Banks⁽¹⁾⁽²⁾

I/O Standard	V_{IL}		V_{IH}		V_{OL}	V_{OH}	I_{OL}	I_{OH}
	V, Min	V, Max	V, Min	V, Max	V, Max	V, Min	mA	mA
HSTL_I	-0.300	$V_{REF} - 0.100$	$V_{REF} + 0.100$	$V_{CCO} + 0.300$	0.400	$V_{CCO} - 0.400$	8.0	-8.0
HSTL_I_18	-0.300	$V_{REF} - 0.100$	$V_{REF} + 0.100$	$V_{CCO} + 0.300$	0.400	$V_{CCO} - 0.400$	8.0	-8.0
HSTL_II	-0.300	$V_{REF} - 0.100$	$V_{REF} + 0.100$	$V_{CCO} + 0.300$	0.400	$V_{CCO} - 0.400$	16.0	-16.0
HSTL_II_18	-0.300	$V_{REF} - 0.100$	$V_{REF} + 0.100$	$V_{CCO} + 0.300$	0.400	$V_{CCO} - 0.400$	16.0	-16.0
HSUL_12	-0.300	$V_{REF} - 0.130$	$V_{REF} + 0.130$	$V_{CCO} + 0.300$	20% V_{CCO}	80% V_{CCO}	0.1	-0.1
LVC MOS12	-0.300	35% V_{CCO}	65% V_{CCO}	$V_{CCO} + 0.300$	0.400	$V_{CCO} - 0.400$	Note 3	Note 3
LVC MOS15	-0.300	35% V_{CCO}	65% V_{CCO}	$V_{CCO} + 0.300$	0.450	$V_{CCO} - 0.450$	Note 4	Note 4
LVC MOS18	-0.300	35% V_{CCO}	65% V_{CCO}	$V_{CCO} + 0.300$	0.450	$V_{CCO} - 0.450$	Note 4	Note 4
LVC MOS25	-0.300	0.700	1.700	$V_{CCO} + 0.300$	0.400	$V_{CCO} - 0.400$	Note 4	Note 4
LVC MOS33	-0.300	0.800	2.000	3.400	0.400	$V_{CCO} - 0.400$	Note 4	Note 4
LV TTL	-0.300	0.800	2.000	3.400	0.400	2.400	Note 4	Note 4
SSTL12	-0.300	$V_{REF} - 0.100$	$V_{REF} + 0.100$	$V_{CCO} + 0.300$	$V_{CCO}/2 - 0.150$	$V_{CCO}/2 + 0.150$	14.25	-14.25
SSTL135	-0.300	$V_{REF} - 0.090$	$V_{REF} + 0.090$	$V_{CCO} + 0.300$	$V_{CCO}/2 - 0.150$	$V_{CCO}/2 + 0.150$	13.0	-13.0
SSTL135_R	-0.300	$V_{REF} - 0.090$	$V_{REF} + 0.090$	$V_{CCO} + 0.300$	$V_{CCO}/2 - 0.150$	$V_{CCO}/2 + 0.150$	8.9	-8.9
SSTL15	-0.300	$V_{REF} - 0.100$	$V_{REF} + 0.100$	$V_{CCO} + 0.300$	$V_{CCO}/2 - 0.175$	$V_{CCO}/2 + 0.175$	13.0	-13.0
SSTL15_R	-0.300	$V_{REF} - 0.100$	$V_{REF} + 0.100$	$V_{CCO} + 0.300$	$V_{CCO}/2 - 0.175$	$V_{CCO}/2 + 0.175$	8.9	-8.9
SSTL18_I	-0.300	$V_{REF} - 0.125$	$V_{REF} + 0.125$	$V_{CCO} + 0.300$	$V_{CCO}/2 - 0.470$	$V_{CCO}/2 + 0.470$	8.0	-8.0
SSTL18_II	-0.300	$V_{REF} - 0.125$	$V_{REF} + 0.125$	$V_{CCO} + 0.300$	$V_{CCO}/2 - 0.600$	$V_{CCO}/2 + 0.600$	13.4	-13.4

Notes:

1. Tested according to relevant specifications.
2. Standards specified using the default I/O standard configuration. For details, see the *UltraScale Architecture SelectIO Resources User Guide* ([UG571](#)).
3. Supported drive strengths of 4, 8, or 12 mA in HR I/O banks.
4. Supported drive strengths of 4, 8, 12, or 16 mA in HR I/O banks.

Table 10: SelectIO DC Input and Output Levels for HP I/O Banks⁽¹⁾⁽²⁾⁽³⁾

I/O Standard	V_{IL}		V_{IH}		V_{OL}	V_{OH}	I_{OL}	I_{OH}
	V, Min	V, Max	V, Min	V, Max	V, Max	V, Min	mA	mA
HSTL_I	-0.300	$V_{REF} - 0.100$	$V_{REF} + 0.100$	$V_{CCO} + 0.300$	0.400	$V_{CCO} - 0.400$	5.8	-5.8
HSTL_I_12	-0.300	$V_{REF} - 0.080$	$V_{REF} + 0.080$	$V_{CCO} + 0.300$	25% V_{CCO}	75% V_{CCO}	4.1	-4.1
HSTL_I_18	-0.300	$V_{REF} - 0.100$	$V_{REF} + 0.100$	$V_{CCO} + 0.300$	0.400	$V_{CCO} - 0.400$	6.2	-6.2
HSUL_12	-0.300	$V_{REF} - 0.130$	$V_{REF} + 0.130$	$V_{CCO} + 0.300$	20% V_{CCO}	80% V_{CCO}	0.1	-0.1
LVC MOS12	-0.300	35% V_{CCO}	65% V_{CCO}	$V_{CCO} + 0.300$	0.400	$V_{CCO} - 0.400$	Note 4	Note 4
LVC MOS15	-0.300	35% V_{CCO}	65% V_{CCO}	$V_{CCO} + 0.300$	0.450	$V_{CCO} - 0.450$	Note 5	Note 5
LVC MOS18	-0.300	35% V_{CCO}	65% V_{CCO}	$V_{CCO} + 0.300$	0.450	$V_{CCO} - 0.450$	Note 5	Note 5
LVDCI_15	-0.300	35% V_{CCO}	65% V_{CCO}	$V_{CCO} + 0.300$	0.450	$V_{CCO} - 0.450$	7.0	-7.0
LVDCI_18	-0.300	35% V_{CCO}	65% V_{CCO}	$V_{CCO} + 0.300$	0.450	$V_{CCO} - 0.450$	7.0	-7.0
SSTL12	-0.300	$V_{REF} - 0.100$	$V_{REF} + 0.100$	$V_{CCO} + 0.300$	$V_{CCO}/2 - 0.150$	$V_{CCO}/2 + 0.150$	8.0	-8.0
SSTL135	-0.300	$V_{REF} - 0.090$	$V_{REF} + 0.090$	$V_{CCO} + 0.300$	$V_{CCO}/2 - 0.150$	$V_{CCO}/2 + 0.150$	9.0	-9.0
SSTL15	-0.300	$V_{REF} - 0.100$	$V_{REF} + 0.100$	$V_{CCO} + 0.300$	$V_{CCO}/2 - 0.175$	$V_{CCO}/2 + 0.175$	10.0	-10.0
SSTL18_I	-0.300	$V_{REF} - 0.125$	$V_{REF} + 0.125$	$V_{CCO} + 0.300$	$V_{CCO}/2 - 0.470$	$V_{CCO}/2 + 0.470$	7.0	-7.0

Notes:

1. Tested according to relevant specifications.
2. Standards specified using the default I/O standard configuration. For details, see the *UltraScale Architecture SelectIO Resources User Guide* ([UG571](#)).
3. POD10 and POD12 DC input and output levels are shown in [Table 11](#), [Table 16](#), and [Table 17](#).
4. Supported drive strengths of 2, 4, 6, or 8 mA in HP I/O banks.
5. Supported drive strengths of 2, 4, 6, 8, or 12 mA in HP I/O banks.

Table 11: DC Input Levels for Single-ended POD10 and POD12 I/O Standards⁽¹⁾⁽²⁾

I/O Standard	V_{IL}		V_{IH}	
	V, Min	V, Max	V, Min	V, Max
POD10	-0.300	$V_{REF} - 0.068$	$V_{REF} + 0.068$	$V_{CCO} + 0.300$
POD12	-0.300	$V_{REF} - 0.068$	$V_{REF} + 0.068$	$V_{CCO} + 0.300$

Notes:

1. Tested according to relevant specifications.
2. Standards specified using the default I/O standard configuration. For details, see the *UltraScale Architecture SelectIO Resources User Guide* ([UG571](#)).



Table 12: Differential SelectIO DC Input and Output Levels

I/O Standard	V_{ICM} (V) ⁽¹⁾			V_{ID} (V) ⁽²⁾			V_{OCM} (V) ⁽³⁾			V_{OD} (V) ⁽⁴⁾		
	Min	Typ	Max	Min	Typ	Max	Min	Typ	Max	Min	Typ	Max
BLVDS_25	0.300	1.200	1.425	0.100	–	–	–	1.250	–	Note 5		
MINI_LVDS_25	0.300	1.200	V_{CCAUX}	0.200	0.400	0.600	1.000	1.200	1.485	0.300	0.450	0.600
SUB_LVDS	0.500	0.900	1.300	0.070	–	–	0.700	0.900	1.100	0.100	0.150	0.200
LVPECL	0.300	1.200	1.425	0.100	0.350	0.600	–	–	–	–	–	–
PPDS_25	0.200	0.900	V_{CCAUX}	0.100	0.250	0.400	0.500	0.950	1.400	0.100	0.250	0.400
RSDS_25	0.300	0.900	1.500	0.100	0.350	0.600	1.000	1.200	1.485	0.100	0.350	0.600
SLVS_400_18	0.070	0.200	0.330	0.140	–	0.450	–	–	–	–	–	–
SLVS_400_25	0.070	0.200	0.330	0.140	–	0.450	–	–	–	–	–	–
TMDS_33	2.700	2.965	3.230	0.150	0.675	1.200	$V_{CCO} - 0.405$	$V_{CCO} - 0.300$	$V_{CCO} - 0.190$	0.400	0.600	0.800

Notes:

- V_{ICM} is the input common mode voltage.
- V_{ID} is the input differential voltage ($Q - \bar{Q}$).
- V_{OCM} is the output common mode voltage.
- V_{OD} is the output differential voltage ($Q - \bar{Q}$).
- V_{OD} for BLVDS will vary significantly depending on topology and loading.
- LVDS_25 is specified in Table 18.
- LVDS is specified in Table 19.

Table 13: Complementary Differential SelectIO DC Input and Output Levels for HR I/O Banks

I/O Standard	V_{ICM} (V) ⁽¹⁾			V_{ID} (V) ⁽²⁾		V_{OL} (V) ⁽³⁾	V_{OH} (V) ⁽⁴⁾	I_{OL}	I_{OH}
	Min	Typ	Max	Min	Max	Max	Min	mA	mA
DIFF_HSTL_I	0.300	0.750	1.125	0.100	–	0.400	$V_{CCO} - 0.400$	8.0	–8.0
DIFF_HSTL_I_18	0.300	0.900	1.425	0.100	–	0.400	$V_{CCO} - 0.400$	8.0	–8.0
DIFF_HSTL_II	0.300	0.750	1.125	0.100	–	0.400	$V_{CCO} - 0.400$	16.0	–16.0
DIFF_HSTL_II_18	0.300	0.900	1.425	0.100	–	0.400	$V_{CCO} - 0.400$	16.0	–16.0
DIFF_HSUL_12	0.300	0.600	0.850	0.100	–	20% V_{CCO}	80% V_{CCO}	0.1	–0.1
DIFF_SSTL12	0.300	0.600	0.850	0.100	–	$(V_{CCO}/2) - 0.150$	$(V_{CCO}/2) + 0.150$	14.25	–14.25
DIFF_SSTL135	0.300	0.675	1.000	0.100	–	$(V_{CCO}/2) - 0.150$	$(V_{CCO}/2) + 0.150$	13.0	–13.0
DIFF_SSTL135_R	0.300	0.675	1.000	0.100	–	$(V_{CCO}/2) - 0.150$	$(V_{CCO}/2) + 0.150$	8.9	–8.9
DIFF_SSTL15	0.300	0.750	1.125	0.100	–	$(V_{CCO}/2) - 0.175$	$(V_{CCO}/2) + 0.175$	13.0	–13.0
DIFF_SSTL15_R	0.300	0.750	1.125	0.100	–	$(V_{CCO}/2) - 0.175$	$(V_{CCO}/2) + 0.175$	8.9	–8.9
DIFF_SSTL18_I	0.300	0.900	1.425	0.100	–	$(V_{CCO}/2) - 0.470$	$(V_{CCO}/2) + 0.470$	8.0	–8.0
DIFF_SSTL18_II	0.300	0.900	1.425	0.100	–	$(V_{CCO}/2) - 0.600$	$(V_{CCO}/2) + 0.600$	13.4	–13.4

Notes:

- V_{ICM} is the input common mode voltage.
- V_{ID} is the input differential voltage.
- V_{OL} is the single-ended low-output voltage.
- V_{OH} is the single-ended high-output voltage.

Table 14: Complementary Differential SelectIO DC Input and Output Levels for HP I/O Banks⁽¹⁾

I/O Standard	V_{ICM} (V) ⁽²⁾			V_{ID} (V) ⁽³⁾		V_{OL} (V) ⁽⁴⁾	V_{OH} (V) ⁽⁵⁾	I_{OL}	I_{OH}
	Min	Typ	Max	Min	Max	Max	Min	mA	mA
DIFF_HSTL_I	0.680	$V_{CCO}/2$	$(V_{CCO}/2) + 0.150$	0.100	–	0.400	$V_{CCO} - 0.400$	5.8	–5.8
DIFF_HSTL_I_12	$0.400 \times V_{CCO}$	$V_{CCO}/2$	$0.600 \times V_{CCO}$	0.100	–	$0.250 \times V_{CCO}$	$0.750 \times V_{CCO}$	4.1	–4.1
DIFF_HSTL_I_18	$(V_{CCO}/2) - 0.175$	$V_{CCO}/2$	$(V_{CCO}/2) + 0.175$	0.100	–	0.400	$V_{CCO} - 0.400$	6.2	–6.2
DIFF_HSUL_12	$(V_{CCO}/2) - 0.120$	$V_{CCO}/2$	$(V_{CCO}/2) + 0.120$	0.100	–	$20\% V_{CCO}$	$80\% V_{CCO}$	0.1	–0.1
DIFF_SSTL12	$(V_{CCO}/2) - 0.150$	$V_{CCO}/2$	$(V_{CCO}/2) + 0.150$	0.100	–	$(V_{CCO}/2) - 0.150$	$(V_{CCO}/2) + 0.150$	8.0	–8.0
DIFF_SSTL135	$(V_{CCO}/2) - 0.150$	$V_{CCO}/2$	$(V_{CCO}/2) + 0.150$	0.100	–	$(V_{CCO}/2) - 0.150$	$(V_{CCO}/2) + 0.150$	9.0	–9.0
DIFF_SSTL15	$(V_{CCO}/2) - 0.175$	$V_{CCO}/2$	$(V_{CCO}/2) + 0.175$	0.100	–	$(V_{CCO}/2) - 0.175$	$(V_{CCO}/2) + 0.175$	10.0	–10.0
DIFF_SSTL18_I	$(V_{CCO}/2) - 0.175$	$V_{CCO}/2$	$(V_{CCO}/2) + 0.175$	0.100	–	$(V_{CCO}/2) - 0.470$	$(V_{CCO}/2) + 0.470$	7.0	–7.0

Notes:

1. DIFF_POD10 and DIFF_POD12 HP I/O bank specifications are shown in [Table 15](#), [Table 16](#), and [Table 17](#).
2. V_{ICM} is the input common mode voltage.
3. V_{ID} is the input differential voltage.
4. V_{OL} is the single-ended low-output voltage.
5. V_{OH} is the single-ended high-output voltage.

Table 15: DC Input Levels for Differential POD10 and POD12 I/O Standards⁽¹⁾⁽²⁾

I/O Standard	V_{ICM} (V)			V_{ID} (V)	
	Min	Typ	Max	Min	Max
DIFF_POD10	0.63	0.70	0.77	0.14	–
DIFF_POD12	0.76	0.84	0.92	0.16	–

Notes:

1. Tested according to relevant specifications.
2. Standards specified using the default I/O standard configuration. For details, see the *UltraScale Architecture SelectIO Resources User Guide* ([UG571](#)).

Table 16: DC Output Levels for Single-ended and Differential POD10 and POD12 Standards⁽¹⁾⁽²⁾

Symbol	Description	V_{OUT}	Min	Typ	Max	Units
R_{OL}	Pull-down resistance	V_{OM_DC} (as described in Table 17)	36	40	44	Ω
R_{OH}	Pull-up resistance	V_{OM_DC} (as described in Table 17)	36	40	44	Ω

Notes:

1. Tested according to relevant specifications.
2. Standards specified using the default I/O standard configuration. For details, see the *UltraScale Architecture SelectIO Resources User Guide* ([UG571](#)).

Table 17: [Table 16](#) Definitions for DC Output Levels for POD Standards

Symbol	Description	All Devices	Units
V_{OM_DC}	DC output Mid measurement level (for IV curve linearity)	$0.8 \times V_{CCO}$	V



LVDS DC Specifications (LVDS_25)

The LVDS_25 standard is available in the HR I/O banks. See the *UltraScale Architecture SelectIO Resources User Guide* ([UG571](#)) for more information.

Table 18: LVDS_25 DC Specifications

Symbol	DC Parameter	Conditions	Min	Typ	Max	Units
V_{CCO}	Supply voltage		2.375	2.500	2.625	V
$V_{ODIFF}^{(1)}$	Differential Output Voltage: ($\underline{Q} - \overline{Q}$), $\underline{Q} = \text{High}$ ($\overline{Q} - \underline{Q}$), $\overline{Q} = \text{High}$	$R_T = 100\Omega$ across \underline{Q} and \overline{Q} signals	247	350	600	mV
$V_{OCM}^{(1)}$	Output Common-Mode Voltage	$R_T = 100\Omega$ across \underline{Q} and \overline{Q} signals	1.000	1.250	1.485	V
V_{IDIFF}	Differential Input Voltage: ($\underline{Q} - \overline{Q}$), $\underline{Q} = \text{High}$ ($\overline{Q} - \underline{Q}$), $\overline{Q} = \text{High}$		100	350	600 ⁽²⁾	mV
$V_{ICM_DC}^{(3)}$	Input Common-Mode Voltage (DC Coupling)		0.300	1.200	1.500	V
$V_{ICM_AC}^{(4)}$	Input Common-Mode Voltage (AC Coupling)		0.600	–	1.100	V

Notes:

- V_{OCM} and V_{ODIFF} values are for LVDS_PRE_EMPHASIS = FALSE.
- Maximum V_{IDIFF} value is specified for the maximum V_{ICM} specification. With a lower V_{ICM} , a higher V_{IDIFF} is tolerated only when the recommended operating conditions and overshoot/undershoot V_{IN} specifications are maintained.
- Input common mode voltage for DC coupled configurations. EQUALIZATION = EQ_NONE (Default).
- External input common mode voltage specification for AC coupled configurations. EQUALIZATION = EQ_LEVEL0, EQ_LEVEL1, EQ_LEVEL2, EQ_LEVEL3, EQ_LEVEL4.

LVDS DC Specifications (LVDS)

The LVDS standard is available in the HP I/O banks. See the *UltraScale Architecture SelectIO Resources User Guide* ([UG571](#)) for more information.

Table 19: LVDS DC Specifications

Symbol	DC Parameter	Conditions	Min	Typ	Max	Units
V_{CCO}	Supply voltage		1.710	1.800	1.890	V
$V_{ODIFF}^{(1)}$	Differential Output Voltage ($\underline{Q} - \overline{Q}$), $\underline{Q} = \text{High}$ ($\overline{Q} - \underline{Q}$), $\overline{Q} = \text{High}$	$R_T = 100\Omega$ across \underline{Q} and \overline{Q} signals	247	350	600	mV
$V_{OCM}^{(1)}$	Output Common-Mode Voltage	$R_T = 100\Omega$ across \underline{Q} and \overline{Q} signals	1.000	1.250	1.425	V
V_{IDIFF}	Differential Input Voltage ($\underline{Q} - \overline{Q}$), $\underline{Q} = \text{High}$ ($\overline{Q} - \underline{Q}$), $\overline{Q} = \text{High}$		100	350	600 ⁽²⁾	mV
$V_{ICM_DC}^{(3)}$	Input Common-Mode Voltage (DC Coupling)		0.300	1.200	1.425	V
$V_{ICM_AC}^{(4)}$	Input Common-Mode Voltage (AC Coupling)		0.600	–	1.100	V

Notes:

- V_{OCM} and V_{ODIFF} values are for LVDS_PRE_EMPHASIS = FALSE.
- Maximum V_{IDIFF} value is specified for the maximum V_{ICM} specification. With a lower V_{ICM} , a higher V_{IDIFF} is tolerated only when the recommended operating conditions and overshoot/undershoot V_{IN} specifications are maintained.
- Input common mode voltage for DC coupled configurations. EQUALIZATION = EQ_NONE (Default).
- External input common mode voltage specification for AC coupled configurations. EQUALIZATION = EQ_LEVEL0, EQ_LEVEL1, EQ_LEVEL2, EQ_LEVEL3, EQ_LEVEL4.

AC Switching Characteristics

All values represented in this data sheet are based on the speed specifications in the Vivado™ Design Suite as outlined in [Table 20](#).

Table 20: Speed Specification Version By Device

2016.4	Device
1.23	XCKU025, XCKU035, XCKU040, XCKU060, XQKU040, XQKU060
1.24	XCKU085, XCKU095, XCKU115, XQKU095, XQKU115

Switching characteristics are specified on a per-speed-grade basis and can be designated as Advance, Preliminary, or Production. Each designation is defined as follows:

Advance Product Specification

These specifications are based on simulations only and are typically available soon after device design specifications are frozen. Although speed grades with this designation are considered relatively stable and conservative, some under-reporting might still occur.

Preliminary Product Specification

These specifications are based on complete ES (engineering sample) silicon characterization. Devices and speed grades with this designation are intended to give a better indication of the expected performance of production silicon. The probability of under-reporting delays is greatly reduced as compared to Advance data.

Product Specification

These specifications are released once enough production silicon of a particular device family member has been characterized to provide full correlation between specifications and devices over numerous production lots. There is no under-reporting of delays, and customers receive formal notification of any subsequent changes. Typically, the slowest speed grades transition to production before faster speed grades.

Testing of AC Switching Characteristics

Internal timing parameters are derived from measuring internal test patterns. All AC switching characteristics are representative of worst-case supply voltage and junction temperature conditions.

For more specific, more precise, and worst-case guaranteed data, use the values reported by the static timing analyzer and back-annotate to the simulation net list. Unless otherwise noted, values apply to all Kintex UltraScale FPGAs.



Speed Grade Designations

Since individual family members are produced at different times, the migration from one category to another depends completely on the status of the fabrication process for each device. [Table 21](#) correlates the current status of the Kintex UltraScale FPGAs on a per speed grade basis.

Table 21: Speed Grade Designations by Device

Device	Speed Grade and V_{CCINT} Operating Voltages		
	Advance	Preliminary	Production
XCKU025			-2 (0.95V) and -1 (0.95V)
XCKU035			-3 (1.0V), -2 (0.95V), -1 (0.95V), -1L (0.95V), and -1L (0.90V) ⁽¹⁾
XCKU040			-3 (1.0V), -2 (0.95V), -1 (0.95V), -1L (0.95V), and -1L (0.90V) ⁽¹⁾
XCKU060			-3 (1.0V), -2 (0.95V), -1 (0.95V), -1L (0.95V), and -1L (0.90V) ⁽¹⁾
XCKU085			-3 (1.0V), -2 (0.95V), -1 (0.95V), -1L (0.95V), and -1L (0.90V) ⁽¹⁾
XCKU095			-2 (0.95V) and -1 (0.95V)
XCKU115			-3 (1.0V), -2 (0.95V), -1 (0.95V), -1L (0.95V), and -1L (0.90V) ⁽¹⁾
XQKU040			-2 (0.95V) and -1 (0.95V)
XQKU060			-2 (0.95V) and -1 (0.95V)
XQKU095			-2 (0.95V) and -1 (0.95V)
XQKU115			-2 (0.95V) and -1 (0.95V)

Notes:

1. The lowest power -1L devices, where $V_{CCINT} = 0.90V$, are listed in the Vivado Design Suite as -1LV.



Production Silicon and Software Status

In some cases, a particular family member (and speed grade) is released to production before a speed specification is released with the correct label (Advance, Preliminary, Production). Any labeling discrepancies are corrected in subsequent speed specification releases.

Table 22 lists the production released Kintex UltraScale FPGAs, speed grade, and the minimum corresponding supported speed specification version and Vivado software revisions. The Vivado software and speed specifications listed are the minimum releases required for production. All subsequent releases of software and speed specifications are valid.

Table 22: Kintex UltraScale FPGAs Production Software and Speed Specification Release⁽¹⁾

Device	Speed Grade, Temperature Ranges, and V_{CCINT} Operating Voltages					
	1.0V	0.95V				0.90V
	-3E	-2E, -2I	-1C, -1I	-1M	-1LI	-1LI ⁽³⁾
XCKU025 ⁽²⁾	N/A	Vivado Tools 2015.3 v1.23		N/A	N/A	N/A
XCKU035 ⁽²⁾	Vivado Tools 2015.2.1 v1.23 for FBVA676 and FFVA1156 packages	Vivado Tools 2015.1 v1.23 for FBVA676 and FFVA1156 packages		N/A	Vivado Tools 2015.3 v1.23	
	Vivado Tools 2015.3 v1.23 for FBVA900			N/A		
	Vivado Tools 2015.4 v1.23 for SFVA784			N/A	Vivado Tools 2015.4 v1.23 for SFVA784	
XCKU040 ⁽²⁾	Vivado Tools 2015.2.1 v1.23 for FBVA676 and FFVA1156 packages	Vivado Tools 2015.1 v1.23 for FBVA676 and FFVA1156 packages		N/A	Vivado Tools 2015.3 v1.23	
	Vivado Tools 2015.3 v1.23 for FBVA900			N/A		
	Vivado Tools 2015.4 v1.23 for SFVA784			N/A	Vivado Tools 2015.4 v1.23 for SFVA784	
XCKU060 ⁽²⁾	Vivado Tools 2015.4 v1.23	Vivado Tools 2015.2 v1.23		N/A	Vivado Tools 2015.3 v1.23	Vivado Tools 2015.4 v1.23
XCKU085 ⁽²⁾	Vivado Tools 2015.4 v1.24	Vivado Tools 2015.3 v1.24		N/A	Vivado Tools 2016.1 v1.24	
XCKU095	N/A	Vivado Tools 2015.3 v1.24		N/A	N/A	N/A
XCKU115 ⁽²⁾	Vivado Tools 2015.4 v1.24	Vivado Tools 2015.2.1 v1.24		N/A	Vivado Tools 2016.1 v1.24	
XQKU040	N/A	Vivado Tools 2016.4 v1.23			N/A	N/A
XQKU060	N/A	Vivado Tools 2016.4 v1.23			N/A	N/A
XQKU095	N/A	Vivado Tools 2016.4 v1.24			N/A	N/A
XQKU115	N/A	Vivado Tools 2016.4 v1.24		N/A	N/A	N/A

Notes:

- For designs developed using Vivado tools prior to 2016.4, see the design advisory answer record [AR68169: Design Advisory for Kintex UltraScale FPGAs and Virtex UltraScale FPGAs—New minimum production speed specification version \(Speed File\) required for all designs.](#)
- Designs with these devices that use the dedicated System Monitor I2C (I2C_SCL and I2C_SDA) or PCIe reset (PERSTN0 or PERSTN1) I/O where the bank 65 $V_{CC0} = 3.3V$ must use Vivado Design Suite 2015.4 or later.
- The lowest power -1L devices, where $V_{CCINT} = 0.90V$, are listed in the Vivado Design Suite as -1LV.



Performance Characteristics

This section provides the performance characteristics of some common functions and designs implemented in Kintex UltraScale FPGAs. These values are subject to the same guidelines as the [AC Switching Characteristics, page 17](#). In each table, the I/O bank type is either high performance (HP) or high range (HR).

In LVDS component mode:

- For the input/output registers, the Vivado tools limit clock frequencies to 364.9 MHz for -3 and -2 speed grades or 316.4 MHz for -1 speed grade.
- For IDDR, Vivado tools limit clock frequencies to 729.2 MHz for -3 and -2 speed grades or 632.0 MHz for -1 speed grade, though performance beyond the speeds outlined below is not implied.
- For ODDR, Vivado tools limit clock frequencies to 730.4 MHz for all speed grades, though performance beyond the speeds outlined below is not implied.

Table 23: LVDS Component Mode Performance

Description	I/O Bank Type	Speed Grade and V _{CCINT} Operating Voltages								Units
		1.0V		0.95V				0.90V		
		-3		-2		-1/-1L		-1L		
		Min	Max	Min	Max	Min	Max	Min	Max	
LVDS TX DDR (OSERDES 4:1, 8:1)	HP	0	1250	0	1250	0	1250	0	1250	Mb/s
	HR	0	1250	0	1250	0	1000	0	1000	Mb/s
LVDS TX SDR (OSERDES 2:1, 4:1)	HP	0	625	0	625	0	625	0	625	Mb/s
	HR	0	625	0	625	0	500	0	500	Mb/s
LVDS RX DDR (ISERDES 1:4, 1:8) ⁽¹⁾	HP	0	1250	0	1250	0	1250	0	1250	Mb/s
	HR	0	1250	0	1250	0	1000	0	1000	Mb/s
LVDS RX SDR (ISERDES 1:2, 1:4) ⁽¹⁾	HP	0	625	0	625	0	625	0	625	Mb/s
	HR	0	625	0	625	0	500	0	500	Mb/s

Notes:

- LVDS receivers are typically bounded with certain applications where specific dynamic phase-alignment (DPA) or phase-tracking algorithms are used to achieve maximum performance.

Table 24: LVDS Native Mode Performance⁽¹⁾

Description	I/O Bank Type	Speed Grade and V _{CCINT} Operating Voltages								Units
		1.0V		0.95V				0.90V		
		-3		-2		-1/-1L		-1L		
		Min	Max	Min	Max	Min	Max	Min	Max	
LVDS TX DDR (TX_BITSLICE 4:1, 8:1)	HP	300	1600	300	1600	300	1400	300	1400	Mb/s
	HR	300	1250	300	1250	300	1250	300	1250	Mb/s
LVDS TX SDR (TX_BITSLICE 2:1, 4:1)	HP	150	800	150	800	150	700	150	700	Mb/s
	HR	150	625	150	625	150	625	150	625	Mb/s
LVDS RX DDR (RX_BITSLICE 1:4, 1:8) ⁽²⁾	HP	300	1600 ⁽³⁾	300	1600 ⁽³⁾	300	1400 ⁽³⁾	300	1400 ⁽³⁾	Mb/s
	HR	300	1250	300	1250	300	1250	300	1250	Mb/s

Table 24: LVDS Native Mode Performance⁽¹⁾ (Cont'd)

Description	I/O Bank Type	Speed Grade and V _{CCINT} Operating Voltages								Units
		1.0V		0.95V				0.90V		
		-3		-2		-1/-1L		-1L		
		Min	Max	Min	Max	Min	Max	Min	Max	
LVDS RX SDR (RX_BITSLICE 1:2, 1:4) ⁽²⁾	HP	150	800	150	800	150	700	150	700	Mb/s
	HR	150	625	150	625	150	625	150	625	Mb/s

Notes:

1. Native mode is supported through the [High-Speed SelectIO Interface Wizard](#) available with the Vivado Design Suite.
2. LVDS receivers are typically bounded with certain applications where specific dynamic phase-alignment (DPA) or phase-tracking algorithms are used to achieve maximum performance.
3. Asynchronous receiver performance is limited to 1300 Mb/s for -3 and -2 speed grades, and 1250 Mb/s for -1 and -1L speed grades.

Table 25: LVDS Native-Mode 1000BASE-X Support⁽¹⁾

Description	I/O Bank Type	Speed Grade and V _{CCINT} Operating Voltages							
		1.0V		0.95V		0.90V			
		-3		-2		-1/-1L		-1L	
1000BASE-X	HP	Yes		Yes		Yes		Yes	

Notes:

1. 1000BASE-X support is based on the *IEEE Standard for CSMA/CD Access Method and Physical Layer Specifications* (IEEE Std 802.3-2008).



Table 26 provides the maximum data rates for applicable memory standards using the Kintex UltraScale FPGAs memory PHY. Refer to [Memory Interfaces](#) for the complete list of memory interface standards supported and detailed specifications. The final performance of the memory interface is determined through a complete design implemented in the Vivado Design Suite, following guidelines in the *UltraScale Architecture PCB Design Guide (UG583)*, electrical analysis, and characterization of the system.

Table 26: Maximum Physical Interface (PHY) Rate for Memory Interfaces by I/O and Package

Memory Standard	I/O Bank Type	Package	DRAM Type	Speed Grade, Temperature Ranges, and V _{CCINT} Operating Voltages					Units	
				1.0V	0.95V			0.90V		
				-3E	-2E	-2I	-1C/I -1M -1LI	-1LI		
DDR4	HP	All FF/RF packages All FL/RL packages FBVA900	Single rank component	2400	2400	2400	2133	2133	Mb/s	
			1 rank DIMM ⁽¹⁾⁽²⁾	2133	2133	2133	1866	1866		
			2 rank DIMM ⁽¹⁾⁽³⁾	1866	1866	1866	1600	1600		
		4 rank DIMM ⁽¹⁾⁽⁴⁾	1333	1333	1333	N/A	N/A			
		FBVA676 RBA676 SFVA784	Single rank component	2133	2133	2133	1866	1866		
			1 rank DIMM ⁽¹⁾⁽²⁾	1866	1866	1866	1600	1600		
2 rank DIMM ⁽¹⁾⁽³⁾	1600		1600	1600	1600	1600				
DDR3	HP	All FF/RF packages All FL/RL packages FBVA676 RBA676 FBVA900	Single rank component	2133	2133	2133	1866	1866	Mb/s	
			1 rank DIMM ⁽¹⁾⁽²⁾	1866	1866	1866	1600	1600		
			2 rank DIMM ⁽¹⁾⁽³⁾	1600	1600	1600	1333	1333		
			4 rank DIMM ⁽¹⁾⁽⁴⁾	1066	1066	1066	800	800		
		SFVA784	Single rank component	1866	1866	1866	1600	1600		
			1 rank DIMM ⁽¹⁾⁽²⁾	1600	1600	1600	1600	1600		
			2 rank DIMM ⁽¹⁾⁽³⁾	1600	1600	1600	1333	1333		
	HR	All	Single rank component	1333 ⁽⁵⁾			1066	1066		
			All FF/RF packages All FL/RL packages FBVA676 RBA676 FBVA900	Single rank component	1866	1866	1866	1600	1600	Mb/s
				1 rank DIMM ⁽¹⁾⁽²⁾	1600	1600	1600	1333	1333	
2 rank DIMM ⁽¹⁾⁽³⁾	1333	1333		1333	1066	1066				
4 rank DIMM ⁽¹⁾⁽⁴⁾	800	800		800	606	606				
DDR3L	HP	All FF/RF packages All FL/RL packages FBVA676 RBA676 FBVA900	Single rank component	1600	1600	1600	1600	1600		
			1 rank DIMM ⁽¹⁾⁽²⁾	1600	1600	1600	1333	1333		
			2 rank DIMM ⁽¹⁾⁽³⁾	1333	1333	1333	1066	1066		
			4 rank DIMM ⁽¹⁾⁽⁴⁾	800	800	800	606	606		
	SFVA784	Single rank component	1600	1600	1600	1600	1600			
1 rank DIMM ⁽¹⁾⁽²⁾		1600	1600	1600	1333	1333				
2 rank DIMM ⁽¹⁾⁽³⁾		1333	1333	1333	1066	1066				
4 rank DIMM ⁽¹⁾⁽⁴⁾		800	800	800	606	606				
HR	All	Single rank component	1066	1066	1066	800	800			



Table 26: Maximum Physical Interface (PHY) Rate for Memory Interfaces by I/O and Package

Memory Standard	I/O Bank Type	Package	DRAM Type	Speed Grade, Temperature Ranges, and V _{CCINT} Operating Voltages					Units
				1.0V	0.95V			0.90V	
				-3E	-2E	-2I	-1C/I -1M -1LI	-1LI	
QDR II+ ⁽⁶⁾	All	All	Single rank component	633	600	600	550	550	MHz
QDRIV-XP	HP	All	Single rank component	800	800	800	667	667 ⁽⁷⁾	
RLDRAM III	HP	All FF/RF packages All FL/RL packages FBVA676 RBA676 FBVA900	Single rank component	1066	1066	1066	933	933	
		SFVA784		933	933	933	800	800	
LPDDR3	HP	All	Single rank component	1600	1600	1600	1600	1600	Mb/s
	HR	All	Single rank component	1066	1066	1066	1066	1066	

Notes:

1. Dual in-line memory module (DIMM) includes RDIMM, SODIMM, UDIMM, and LRDIMM.
2. Includes: 1 rank 1 slot, DDP 2 rank, LRDIMM 2 or 4 rank 1 slot.
3. Includes: 2 rank 1 slot, 1 rank 2 slot, LRDIMM 2 rank 2 slot.
4. Includes: 2 rank 2 slot, 4 rank 1 slot.
5. Memory device must be rated at 1600 or above.
6. The QDRII+ performance specifications are for burst-length 4 (BL = 4) implementations.
7. The supported temperature range for QDRIV-XP -1L is 0°C to 100°C



IOB Pad Input, Output, and 3-State

Table 27 (high-range IOB (HR)) and Table 28 (high-performance IOB (HP)) summarizes the values of standard-specific data input delay adjustments, output delays terminating at pads (based on standard) and 3-state delays.

- $T_{\text{INBUF_DELAY_PAD_I}}$ is the delay from IOB pad through the input buffer to the I-pin of an IOB pad. The delay varies depending on the capability of the SelectIO input buffer.
- $T_{\text{OUTBUF_DELAY_O_PAD}}$ is the delay from the O pin to the IOB pad through the output buffer of an IOB pad. The delay varies depending on the capability of the SelectIO output buffer.
- $T_{\text{OUTBUF_DELAY_TD_PAD}}$ is the delay from the T pin to the IOB pad through the output buffer of an IOB pad, when 3-state is disabled. The delay varies depending on the SelectIO capability of the output buffer. In HP I/O banks, the internal DCI termination turn-on time is always faster than $T_{\text{OUTBUF_DELAY_TD_PAD}}$ when the DCITERMDISABLE pin is used. In HR I/O banks, the on-die termination turn-on time is always faster than $T_{\text{OUTBUF_DELAY_TD_PAD}}$ when the INTERMDISABLE pin is used.

Table 27: IOB High Range (HR) Switching Characteristics

I/O Standards	$T_{\text{INBUF_DELAY_PAD_I}}$					$T_{\text{OUTBUF_DELAY_O_PAD}}$					$T_{\text{OUTBUF_DELAY_TD_PAD}}$					Units				
	1.0V		0.95V			0.9V		1.0V		0.95V			0.9V		1.0V		0.95V		0.9V	
	-3	-2	-1/ -1L	-1M	-1L	-3	-2	-1/ -1L	-1M	-1L	-3	-2	-1/ -1L	-1M	-1L		-3	-2	-1/ -1L	-1M
BLVDS_25	0.46	0.58	0.64	0.64	0.64	1.37	1.37	1.62	1.62	1.62	1.39	1.40	1.66	1.66	1.66	ns				
DIFF_HSTL_I_18_F	0.42	0.53	0.57	0.57	0.57	0.71	0.71	0.90	0.90	0.91	0.82	0.82	1.06	1.06	1.06	ns				
DIFF_HSTL_I_18_S	0.42	0.53	0.57	0.57	0.57	0.83	0.83	1.02	1.02	1.03	0.93	0.94	1.16	1.16	1.16	ns				
DIFF_HSTL_I_F	0.42	0.53	0.57	0.57	0.57	0.73	0.73	0.92	0.92	0.93	0.90	0.90	1.14	1.14	1.14	ns				
DIFF_HSTL_I_S	0.42	0.53	0.57	0.57	0.57	0.77	0.77	0.96	0.96	0.96	0.95	0.98	1.23	1.23	1.23	ns				
DIFF_HSTL_II_18_F	0.42	0.53	0.57	0.57	0.57	0.80	0.80	0.99	0.99	1.00	0.95	0.98	1.23	1.23	1.23	ns				
DIFF_HSTL_II_18_S	0.42	0.53	0.57	0.57	0.57	0.83	0.83	1.03	1.03	1.03	1.01	1.03	1.28	1.28	1.28	ns				
DIFF_HSTL_II_F	0.42	0.53	0.57	0.57	0.57	0.71	0.71	0.91	0.91	0.91	0.87	0.87	1.11	1.11	1.11	ns				
DIFF_HSTL_II_S	0.42	0.53	0.57	0.57	0.57	0.80	0.80	0.99	0.99	0.99	0.95	0.96	1.20	1.20	1.20	ns				
DIFF_HSUL_12_F	0.42	0.53	0.57	0.57	0.57	0.73	0.73	0.92	0.92	0.92	0.73	0.73	0.92	0.92	0.92	ns				
DIFF_HSUL_12_S	0.42	0.53	0.57	0.57	0.57	0.82	0.82	1.01	1.01	1.02	0.82	0.82	1.01	1.01	1.02	ns				
DIFF_SSTL12_F	0.42	0.53	0.57	0.57	0.57	0.70	0.70	0.89	0.89	0.89	0.81	0.81	1.02	1.02	1.02	ns				
DIFF_SSTL12_S	0.42	0.53	0.57	0.57	0.57	1.04	1.04	1.26	1.26	1.26	1.04	1.04	1.26	1.26	1.26	ns				
DIFF_SSTL135_F	0.42	0.53	0.57	0.57	0.57	0.70	0.70	0.88	0.88	0.88	0.86	0.87	1.09	1.09	1.09	ns				
DIFF_SSTL135_S	0.42	0.53	0.57	0.57	0.57	0.77	0.77	0.96	0.96	0.96	0.93	0.94	1.18	1.18	1.18	ns				
DIFF_SSTL135_R_F	0.42	0.53	0.57	0.57	0.57	0.72	0.72	0.91	0.91	0.91	0.83	0.84	1.06	1.06	1.06	ns				
DIFF_SSTL135_R_S	0.42	0.53	0.57	0.57	0.57	0.80	0.80	1.00	1.00	1.00	0.93	0.93	1.17	1.17	1.17	ns				
DIFF_SSTL15_F	0.42	0.53	0.57	0.57	0.57	0.66	0.66	0.85	0.85	0.85	0.81	0.82	1.05	1.05	1.05	ns				
DIFF_SSTL15_S	0.42	0.53	0.57	0.57	0.57	0.78	0.78	0.98	0.98	0.98	0.96	0.96	1.20	1.20	1.21	ns				
DIFF_SSTL15_R_F	0.42	0.53	0.57	0.57	0.57	0.73	0.73	0.92	0.92	0.92	0.86	0.86	1.09	1.09	1.09	ns				
DIFF_SSTL15_R_S	0.42	0.53	0.57	0.57	0.57	0.81	0.81	1.01	1.01	1.02	0.93	0.94	1.18	1.18	1.18	ns				
DIFF_SSTL18_I_F	0.42	0.53	0.57	0.57	0.57	0.74	0.74	0.94	0.94	0.94	0.92	0.93	1.18	1.18	1.19	ns				
DIFF_SSTL18_I_S	0.42	0.53	0.57	0.57	0.57	0.86	0.86	1.05	1.05	1.06	0.86	0.86	1.05	1.05	1.06	ns				
DIFF_SSTL18_II_F	0.42	0.53	0.57	0.57	0.57	0.71	0.71	0.90	0.90	0.90	0.87	0.88	1.11	1.11	1.12	ns				
DIFF_SSTL18_II_S	0.42	0.53	0.57	0.57	0.57	0.83	0.83	1.03	1.03	1.03	0.99	1.04	1.29	1.29	1.30	ns				



Table 27: IOB High Range (HR) Switching Characteristics (Cont'd)

I/O Standards	T _{INBUF_DELAY_PAD_I}					T _{OUTBUF_DELAY_O_PAD}					T _{OUTBUF_DELAY_TD_PAD}					Units
	1.0V	0.95V			0.9V	1.0V	0.95V			0.9V	1.0V	0.95V			0.9V	
	-3	-2	-1/ -1L	-1M	-1L	-3	-2	-1/ -1L	-1M	-1L	-3	-2	-1/ -1L	-1M	-1L	
HSTL_I_18_F	0.52	0.55	0.59	0.59	0.59	0.73	0.73	0.93	0.93	0.93	0.84	0.84	1.08	1.08	1.08	ns
HSTL_I_18_S	0.52	0.55	0.59	0.59	0.59	0.85	0.85	1.05	1.05	1.05	0.95	0.96	1.18	1.18	1.18	ns
HSTL_I_F	0.52	0.55	0.59	0.59	0.59	0.75	0.75	0.94	0.94	0.95	0.92	0.92	1.16	1.16	1.17	ns
HSTL_I_S	0.52	0.55	0.59	0.59	0.59	0.79	0.79	0.98	0.98	0.99	0.97	1.00	1.25	1.25	1.25	ns
HSTL_II_18_F	0.52	0.55	0.59	0.59	0.59	0.82	0.82	1.01	1.01	1.02	0.97	1.00	1.25	1.25	1.25	ns
HSTL_II_18_S	0.52	0.55	0.59	0.59	0.59	0.85	0.85	1.05	1.05	1.05	1.03	1.05	1.30	1.30	1.30	ns
HSTL_II_F	0.52	0.55	0.59	0.59	0.59	0.73	0.73	0.93	0.93	0.93	0.89	0.90	1.13	1.13	1.13	ns
HSTL_II_S	0.52	0.55	0.59	0.59	0.59	0.82	0.82	1.01	1.01	1.02	0.98	0.98	1.22	1.22	1.22	ns
HSUL_12_F	0.52	0.55	0.59	0.59	0.59	0.75	0.75	0.94	0.94	0.95	0.75	0.75	0.94	0.94	0.95	ns
HSUL_12_S	0.52	0.55	0.59	0.59	0.59	0.84	0.84	1.04	1.04	1.04	0.96	0.97	1.15	1.15	1.15	ns
LVC MOS12_F_12	0.76	0.95	0.95	0.95	0.95	0.95	0.95	1.16	1.16	1.16	0.95	0.95	1.16	1.16	1.16	ns
LVC MOS12_F_4	0.76	0.95	0.95	0.95	0.95	1.13	1.16	1.39	1.39	1.39	1.13	1.16	1.39	1.39	1.39	ns
LVC MOS12_F_8	0.76	0.95	0.95	0.95	0.95	0.97	0.97	1.19	1.19	1.19	0.97	0.97	1.19	1.19	1.19	ns
LVC MOS12_S_12	0.76	0.95	0.95	0.95	0.95	1.06	1.06	1.28	1.28	1.28	1.06	1.06	1.28	1.28	1.28	ns
LVC MOS12_S_4	0.76	0.95	0.95	0.95	0.95	1.27	1.36	1.60	1.60	1.60	1.27	1.36	1.60	1.60	1.60	ns
LVC MOS12_S_8	0.76	0.95	0.95	0.95	0.95	1.10	1.10	1.32	1.32	1.32	1.10	1.10	1.32	1.32	1.32	ns
LVC MOS15_F_12	0.68	0.82	0.87	0.87	0.88	0.96	0.96	1.18	1.18	1.18	0.96	0.96	1.18	1.18	1.18	ns
LVC MOS15_F_16	0.68	0.82	0.87	0.87	0.88	0.94	0.94	1.15	1.15	1.15	0.94	0.94	1.17	1.17	1.17	ns
LVC MOS15_F_4	0.68	0.82	0.87	0.87	0.88	1.15	1.15	1.38	1.38	1.39	1.15	1.15	1.38	1.38	1.39	ns
LVC MOS15_F_8	0.68	0.82	0.87	0.87	0.88	1.02	1.02	1.24	1.24	1.24	1.02	1.02	1.24	1.24	1.24	ns
LVC MOS15_S_12	0.68	0.82	0.87	0.87	0.88	1.07	1.07	1.29	1.29	1.30	1.07	1.07	1.29	1.29	1.30	ns
LVC MOS15_S_16	0.68	0.82	0.87	0.87	0.88	1.04	1.04	1.26	1.26	1.27	1.04	1.04	1.26	1.26	1.27	ns
LVC MOS15_S_4	0.68	0.82	0.87	0.87	0.88	1.28	1.29	1.53	1.53	1.54	1.28	1.29	1.53	1.53	1.54	ns
LVC MOS15_S_8	0.68	0.82	0.87	0.87	0.88	1.11	1.11	1.34	1.34	1.34	1.11	1.11	1.34	1.34	1.34	ns
LVC MOS18_F_12	0.64	0.76	0.79	0.79	0.80	1.04	1.04	1.25	1.25	1.26	1.04	1.04	1.25	1.25	1.26	ns
LVC MOS18_F_16	0.64	0.76	0.79	0.79	0.80	1.00	1.00	1.21	1.21	1.22	1.00	1.00	1.21	1.21	1.22	ns
LVC MOS18_F_4	0.64	0.76	0.79	0.79	0.80	1.17	1.17	1.41	1.41	1.41	1.17	1.17	1.41	1.41	1.41	ns
LVC MOS18_F_8	0.64	0.76	0.79	0.79	0.80	1.10	1.10	1.33	1.33	1.33	1.10	1.10	1.33	1.33	1.33	ns
LVC MOS18_S_12	0.64	0.76	0.79	0.79	0.80	1.11	1.11	1.34	1.34	1.35	1.11	1.11	1.34	1.34	1.35	ns
LVC MOS18_S_16	0.64	0.76	0.79	0.79	0.80	1.11	1.11	1.34	1.34	1.34	1.11	1.11	1.34	1.34	1.34	ns
LVC MOS18_S_4	0.64	0.76	0.79	0.79	0.80	1.32	1.32	1.58	1.58	1.58	1.32	1.32	1.58	1.58	1.58	ns
LVC MOS18_S_8	0.64	0.76	0.79	0.79	0.80	1.18	1.18	1.38	1.38	1.38	1.18	1.18	1.38	1.38	1.38	ns
LVC MOS25_F_12	0.83	0.85	0.90	0.90	0.91	1.54	1.54	1.81	1.81	1.81	1.54	1.54	1.81	1.81	1.81	ns
LVC MOS25_F_16	0.83	0.85	0.90	0.90	0.91	1.56	1.59	1.88	1.88	1.88	1.56	1.59	1.88	1.88	1.88	ns
LVC MOS25_F_4	0.83	0.85	0.90	0.90	0.91	2.24	2.24	2.56	2.56	2.56	2.24	2.24	2.56	2.56	2.56	ns
LVC MOS25_F_8	0.83	0.85	0.90	0.90	0.91	1.67	1.67	1.95	1.95	1.95	1.67	1.67	1.95	1.95	1.95	ns
LVC MOS25_S_12	0.83	0.85	0.90	0.90	0.91	2.05	2.14	2.47	2.47	2.47	2.05	2.14	2.47	2.47	2.47	ns
LVC MOS25_S_16	0.83	0.85	0.90	0.90	0.91	1.84	1.89	2.19	2.19	2.19	1.84	1.89	2.19	2.19	2.19	ns
LVC MOS25_S_4	0.83	0.85	0.90	0.90	0.91	3.23	3.27	3.68	3.68	3.68	3.23	3.27	3.68	3.68	3.68	ns
LVC MOS25_S_8	0.83	0.85	0.90	0.90	0.91	2.11	2.15	2.47	2.47	2.47	2.11	2.15	2.47	2.47	2.47	ns



Table 27: IOB High Range (HR) Switching Characteristics (Cont'd)

I/O Standards	T _{INBUF_DELAY_PAD_I}					T _{OUTBUF_DELAY_O_PAD}					T _{OUTBUF_DELAY_TD_PAD}					Units
	1.0V	0.95V			0.9V	1.0V	0.95V			0.9V	1.0V	0.95V			0.9V	
	-3	-2	-1/-1L	-1M	-1L	-3	-2	-1/-1L	-1M	-1L	-3	-2	-1/-1L	-1M	-1L	
LVC MOS33_F_12	0.96	0.97	1.03	1.03	1.03	1.98	1.98	2.24	2.24	2.24	1.98	1.98	2.24	2.24	2.24	ns
LVC MOS33_F_16	0.96	0.97	1.03	1.03	1.03	1.79	1.79	2.09	2.09	2.09	1.79	1.79	2.09	2.09	2.09	ns
LVC MOS33_F_4	0.96	0.97	1.03	1.03	1.03	2.34	2.34	2.63	2.63	2.63	2.34	2.34	2.63	2.63	2.63	ns
LVC MOS33_F_8	0.96	0.97	1.03	1.03	1.03	2.05	2.05	2.32	2.32	2.33	2.05	2.05	2.32	2.32	2.33	ns
LVC MOS33_S_12	0.96	0.97	1.03	1.03	1.03	2.13	2.13	2.48	2.48	2.48	2.13	2.13	2.48	2.48	2.48	ns
LVC MOS33_S_16	0.96	0.97	1.03	1.03	1.03	2.11	2.11	2.43	2.43	2.43	2.11	2.11	2.43	2.43	2.43	ns
LVC MOS33_S_4	0.96	0.97	1.03	1.03	1.03	3.23	3.23	3.67	3.67	3.67	3.23	3.23	3.67	3.67	3.67	ns
LVC MOS33_S_8	0.96	0.97	1.03	1.03	1.03	2.28	2.28	2.55	2.55	2.55	2.66	2.67	2.78	2.78	2.78	ns
LVDS_25	0.45	0.58	0.62	0.62	0.63	0.80	0.83	0.95	0.96	0.95	105.74	105.74	105.85	105.85	105.85	ns
LVPECL	0.43	0.57	0.62	0.62	0.63	N/A	N/A	N/A	N/A	N/A	N/A	N/A	N/A	N/A	N/A	ns
LVTTL_F_12	1.04	1.04	1.05	1.05	1.06	1.83	1.83	2.10	2.10	2.10	1.83	1.83	2.10	2.10	2.10	ns
LVTTL_F_16	1.04	1.04	1.05	1.05	1.06	1.79	1.79	2.06	2.06	2.06	1.79	1.79	2.06	2.06	2.06	ns
LVTTL_F_4	1.04	1.04	1.05	1.05	1.06	2.34	2.34	2.63	2.63	2.63	2.34	2.34	2.63	2.63	2.63	ns
LVTTL_F_8	1.04	1.04	1.05	1.05	1.06	1.97	1.97	2.22	2.22	2.23	1.97	1.97	2.22	2.22	2.23	ns
LVTTL_S_12	1.04	1.04	1.05	1.05	1.06	1.90	1.90	2.19	2.19	2.19	1.96	1.97	2.19	2.19	2.19	ns
LVTTL_S_16	1.04	1.04	1.05	1.05	1.06	2.07	2.07	2.40	2.40	2.40	2.07	2.07	2.40	2.40	2.40	ns
LVTTL_S_4	1.04	1.04	1.05	1.05	1.06	3.23	3.23	3.67	3.67	3.67	3.23	3.23	3.67	3.67	3.67	ns
LVTTL_S_8	1.04	1.04	1.05	1.05	1.06	2.22	2.22	2.47	2.47	2.47	2.22	2.37	2.50	2.50	2.51	ns
MINI_LVDS_25	0.45	0.58	0.62	0.62	0.63	0.80	0.83	0.95	0.96	0.95	105.74	105.74	105.85	105.85	105.85	ns
PPDS_25	0.45	0.58	0.62	0.62	0.63	0.80	0.83	0.95	0.96	0.95	105.74	105.74	105.85	105.85	105.85	ns
RSDS_25	0.45	0.58	0.62	0.62	0.63	0.80	0.83	0.95	0.96	0.95	105.74	105.74	105.85	105.85	105.85	ns
SLVS_400_25	0.45	0.58	0.62	0.62	0.63	N/A	N/A	N/A	N/A	N/A	N/A	N/A	N/A	N/A	N/A	ns
SSTL12_F	0.52	0.55	0.59	0.59	0.59	0.72	0.72	0.91	0.91	0.91	0.83	0.83	1.04	1.04	1.04	ns
SSTL12_S	0.52	0.55	0.59	0.59	0.59	0.78	0.78	0.97	0.97	0.98	0.88	0.88	1.11	1.11	1.11	ns
SSTL135_F	0.52	0.55	0.59	0.59	0.59	0.72	0.72	0.90	0.90	0.91	0.88	0.89	1.11	1.11	1.11	ns
SSTL135_S	0.52	0.55	0.59	0.59	0.59	0.77	0.77	0.97	0.97	0.97	0.94	0.94	1.18	1.18	1.18	ns
SSTL135_R_F	0.52	0.55	0.59	0.59	0.59	0.74	0.74	0.93	0.93	0.93	0.85	0.86	1.08	1.08	1.08	ns
SSTL135_R_S	0.52	0.55	0.59	0.59	0.59	0.82	0.82	1.02	1.02	1.03	0.95	0.96	1.19	1.19	1.19	ns
SSTL15_F	0.52	0.55	0.59	0.59	0.59	0.68	0.68	0.87	0.87	0.87	0.83	0.84	1.07	1.07	1.07	ns
SSTL15_S	0.52	0.55	0.59	0.59	0.59	0.80	0.80	1.00	1.00	1.01	0.98	0.99	1.23	1.23	1.23	ns
SSTL15_R_F	0.52	0.55	0.59	0.59	0.59	0.75	0.75	0.94	0.94	0.94	0.88	0.89	1.11	1.11	1.11	ns
SSTL15_R_S	0.52	0.55	0.59	0.59	0.59	0.83	0.83	1.04	1.04	1.04	0.95	0.96	1.20	1.20	1.21	ns
SSTL18_I_F	0.52	0.55	0.59	0.59	0.59	0.76	0.76	0.96	0.96	0.96	0.94	0.95	1.21	1.21	1.21	ns
SSTL18_I_S	0.52	0.55	0.59	0.59	0.59	0.88	0.88	1.08	1.08	1.08	0.88	0.88	1.08	1.08	1.08	ns
SSTL18_II_F	0.52	0.55	0.59	0.59	0.59	0.73	0.73	0.92	0.92	0.92	0.89	0.90	1.14	1.14	1.14	ns
SSTL18_II_S	0.52	0.55	0.59	0.59	0.59	0.85	0.85	1.05	1.05	1.05	1.01	1.06	1.32	1.32	1.32	ns
SUB_LVDS	0.45	0.58	0.62	0.62	0.63	0.80	0.83	0.95	0.96	0.95	105.74	105.74	105.85	105.85	105.85	ns
TMDS_33	0.57	0.65	0.73	0.73	0.74	0.80	0.83	0.95	0.96	0.95	105.74	105.74	105.85	105.85	105.85	ns



Table 28: IOB High Performance (HP) Switching Characteristics

I/O Standards	T _{INBUF_DELAY_PAD_I}					T _{OUTBUF_DELAY_O_PAD}					T _{OUTBUF_DELAY_TD_PAD}					Units
	1.0V	0.95V			0.9V	1.0V	0.95V			0.9V	1.0V	0.95V			0.9V	
	-3	-2	-1/ -1L	-1M	-1L	-3	-2	-1/ -1L	-1M	-1L	-3	-2	-1/ -1L	-1M	-1L	
DIFF_HSTL_I_12_F	0.43	0.48	0.55	0.55	0.55	0.46	0.50	0.54	0.54	0.54	0.54	0.62	0.68	0.68	0.68	ns
DIFF_HSTL_I_12_M	0.43	0.48	0.55	0.55	0.55	0.50	0.55	0.60	0.60	0.60	0.60	0.68	0.76	0.76	0.76	ns
DIFF_HSTL_I_12_S	0.43	0.48	0.55	0.55	0.55	0.56	0.61	0.67	0.67	0.67	0.67	0.76	0.85	0.85	0.85	ns
DIFF_HSTL_I_18_F	0.43	0.48	0.55	0.55	0.55	0.45	0.49	0.53	0.53	0.53	0.53	0.61	0.68	0.68	0.68	ns
DIFF_HSTL_I_18_M	0.43	0.48	0.55	0.55	0.55	0.50	0.55	0.59	0.59	0.59	0.59	0.68	0.76	0.76	0.76	ns
DIFF_HSTL_I_18_S	0.43	0.48	0.55	0.55	0.55	0.56	0.62	0.67	0.67	0.67	0.67	0.77	0.86	0.86	0.86	ns
DIFF_HSTL_I_DCI_12_F	0.43	0.48	0.55	0.55	0.55	0.46	0.50	0.54	0.54	0.54	0.54	0.62	0.68	0.68	0.68	ns
DIFF_HSTL_I_DCI_12_M	0.43	0.48	0.55	0.55	0.55	0.50	0.55	0.60	0.60	0.60	0.60	0.68	0.76	0.76	0.76	ns
DIFF_HSTL_I_DCI_12_S	0.43	0.48	0.55	0.55	0.55	0.56	0.61	0.67	0.67	0.67	0.67	0.76	0.85	0.85	0.85	ns
DIFF_HSTL_I_DCI_18_F	0.43	0.48	0.55	0.55	0.55	0.45	0.49	0.53	0.53	0.53	0.53	0.61	0.68	0.68	0.68	ns
DIFF_HSTL_I_DCI_18_M	0.43	0.48	0.55	0.55	0.55	0.50	0.55	0.59	0.59	0.59	0.59	0.68	0.76	0.76	0.76	ns
DIFF_HSTL_I_DCI_18_S	0.43	0.48	0.55	0.55	0.55	0.56	0.62	0.67	0.67	0.67	0.67	0.77	0.86	0.86	0.86	ns
DIFF_HSTL_I_DCI_F	0.43	0.48	0.55	0.55	0.55	0.46	0.50	0.54	0.54	0.54	0.54	0.62	0.68	0.68	0.68	ns
DIFF_HSTL_I_DCI_M	0.43	0.48	0.55	0.55	0.55	0.50	0.55	0.60	0.60	0.60	0.60	0.68	0.76	0.76	0.76	ns
DIFF_HSTL_I_DCI_S	0.43	0.48	0.55	0.55	0.55	0.56	0.61	0.67	0.67	0.67	0.67	0.76	0.85	0.85	0.85	ns
DIFF_HSTL_I_F	0.43	0.48	0.55	0.55	0.55	0.46	0.50	0.54	0.54	0.54	0.54	0.62	0.68	0.68	0.68	ns
DIFF_HSTL_I_M	0.43	0.48	0.55	0.55	0.55	0.50	0.55	0.60	0.60	0.60	0.60	0.68	0.76	0.76	0.76	ns
DIFF_HSTL_I_S	0.43	0.48	0.55	0.55	0.55	0.56	0.61	0.67	0.67	0.67	0.67	0.76	0.85	0.85	0.85	ns
DIFF_HSUL_12_DCI_F	0.43	0.48	0.55	0.55	0.55	0.46	0.50	0.54	0.54	0.54	0.54	0.62	0.68	0.68	0.68	ns
DIFF_HSUL_12_DCI_M	0.43	0.48	0.55	0.55	0.55	0.50	0.55	0.60	0.60	0.60	0.60	0.68	0.76	0.76	0.76	ns
DIFF_HSUL_12_DCI_S	0.43	0.48	0.55	0.55	0.55	0.56	0.61	0.67	0.67	0.67	0.67	0.76	0.85	0.85	0.85	ns
DIFF_HSUL_12_F	0.43	0.48	0.55	0.55	0.55	0.46	0.50	0.54	0.54	0.54	0.54	0.62	0.68	0.68	0.68	ns
DIFF_HSUL_12_M	0.43	0.48	0.55	0.55	0.55	0.50	0.55	0.60	0.60	0.60	0.60	0.68	0.76	0.76	0.76	ns
DIFF_HSUL_12_S	0.43	0.48	0.55	0.55	0.55	0.56	0.61	0.67	0.67	0.67	0.67	0.76	0.85	0.85	0.85	ns
DIFF_POD10_DCI_F	0.43	0.48	0.55	0.55	0.55	0.46	0.50	0.55	0.55	0.55	0.58	0.65	0.73	0.73	0.73	ns
DIFF_POD10_DCI_M	0.43	0.48	0.55	0.55	0.55	0.52	0.58	0.63	0.63	0.63	0.62	0.71	0.79	0.79	0.79	ns
DIFF_POD10_DCI_S	0.43	0.48	0.55	0.55	0.55	0.61	0.68	0.74	0.74	0.74	0.69	0.79	0.88	0.88	0.88	ns
DIFF_POD10_F	0.43	0.48	0.55	0.55	0.55	0.46	0.50	0.55	0.55	0.55	0.58	0.65	0.73	0.73	0.73	ns
DIFF_POD10_M	0.43	0.48	0.55	0.55	0.55	0.52	0.58	0.63	0.63	0.63	0.62	0.71	0.79	0.79	0.79	ns
DIFF_POD10_S	0.43	0.48	0.55	0.55	0.55	0.61	0.68	0.74	0.74	0.74	0.69	0.79	0.88	0.88	0.88	ns
DIFF_POD12_DCI_F	0.43	0.48	0.55	0.55	0.55	0.46	0.50	0.55	0.55	0.55	0.58	0.65	0.73	0.73	0.73	ns
DIFF_POD12_DCI_M	0.43	0.48	0.55	0.55	0.55	0.52	0.58	0.63	0.63	0.63	0.62	0.71	0.79	0.79	0.79	ns
DIFF_POD12_DCI_S	0.43	0.48	0.55	0.55	0.55	0.61	0.68	0.74	0.74	0.74	0.69	0.79	0.88	0.88	0.88	ns
DIFF_POD12_F	0.43	0.48	0.55	0.55	0.55	0.46	0.50	0.55	0.55	0.55	0.58	0.65	0.73	0.73	0.73	ns
DIFF_POD12_M	0.43	0.48	0.55	0.55	0.55	0.52	0.58	0.63	0.63	0.63	0.62	0.71	0.79	0.79	0.79	ns
DIFF_POD12_S	0.43	0.48	0.55	0.55	0.55	0.61	0.68	0.74	0.74	0.74	0.69	0.79	0.88	0.88	0.88	ns
DIFF_SSTL12_DCI_F	0.43	0.48	0.55	0.55	0.55	0.46	0.50	0.54	0.54	0.54	0.54	0.62	0.68	0.68	0.68	ns
DIFF_SSTL12_DCI_M	0.43	0.48	0.55	0.55	0.55	0.50	0.55	0.60	0.60	0.60	0.60	0.68	0.76	0.76	0.76	ns
DIFF_SSTL12_DCI_S	0.43	0.48	0.55	0.55	0.55	0.56	0.61	0.67	0.67	0.67	0.67	0.76	0.85	0.85	0.85	ns
DIFF_SSTL12_F	0.43	0.48	0.55	0.55	0.55	0.46	0.50	0.54	0.54	0.54	0.54	0.62	0.68	0.68	0.68	ns



Table 28: IOB High Performance (HP) Switching Characteristics (Cont'd)

I/O Standards	T _{INBUF_DELAY_PAD_I}					T _{OUTBUF_DELAY_O_PAD}					T _{OUTBUF_DELAY_TD_PAD}					Units
	1.0V	0.95V			0.9V	1.0V	0.95V			0.9V	1.0V	0.95V			0.9V	
	-3	-2	-1/ -1L	-1M	-1L	-3	-2	-1/ -1L	-1M	-1L	-3	-2	-1/ -1L	-1M	-1L	
DIFF_SSTL12_M	0.43	0.48	0.55	0.55	0.55	0.50	0.55	0.60	0.60	0.60	0.60	0.68	0.76	0.76	0.76	ns
DIFF_SSTL12_S	0.43	0.48	0.55	0.55	0.55	0.56	0.61	0.67	0.67	0.67	0.67	0.76	0.85	0.85	0.85	ns
DIFF_SSTL135_DCI_F	0.43	0.48	0.55	0.55	0.55	0.46	0.50	0.54	0.54	0.54	0.54	0.62	0.69	0.69	0.69	ns
DIFF_SSTL135_DCI_M	0.43	0.48	0.55	0.55	0.55	0.50	0.55	0.60	0.60	0.60	0.60	0.68	0.76	0.76	0.76	ns
DIFF_SSTL135_DCI_S	0.43	0.48	0.55	0.55	0.55	0.56	0.61	0.67	0.67	0.67	0.67	0.76	0.85	0.85	0.85	ns
DIFF_SSTL135_F	0.43	0.48	0.55	0.55	0.55	0.46	0.50	0.54	0.54	0.54	0.54	0.62	0.69	0.69	0.69	ns
DIFF_SSTL135_M	0.43	0.48	0.55	0.55	0.55	0.50	0.55	0.60	0.60	0.60	0.60	0.68	0.76	0.76	0.76	ns
DIFF_SSTL135_S	0.43	0.48	0.55	0.55	0.55	0.56	0.61	0.67	0.67	0.67	0.67	0.76	0.85	0.85	0.85	ns
DIFF_SSTL15_DCI_F	0.43	0.48	0.55	0.55	0.55	0.46	0.50	0.54	0.54	0.54	0.54	0.62	0.68	0.68	0.68	ns
DIFF_SSTL15_DCI_M	0.43	0.48	0.55	0.55	0.55	0.50	0.55	0.60	0.60	0.60	0.60	0.68	0.76	0.76	0.76	ns
DIFF_SSTL15_DCI_S	0.43	0.48	0.55	0.55	0.55	0.56	0.61	0.67	0.67	0.67	0.67	0.76	0.85	0.85	0.85	ns
DIFF_SSTL15_F	0.43	0.48	0.55	0.55	0.55	0.46	0.50	0.54	0.54	0.54	0.54	0.62	0.68	0.68	0.68	ns
DIFF_SSTL15_M	0.43	0.48	0.55	0.55	0.55	0.50	0.55	0.60	0.60	0.60	0.60	0.68	0.76	0.76	0.76	ns
DIFF_SSTL15_S	0.43	0.48	0.55	0.55	0.55	0.56	0.61	0.67	0.67	0.67	0.67	0.76	0.85	0.85	0.85	ns
DIFF_SSTL18_I_DCI_F	0.43	0.48	0.55	0.55	0.55	0.45	0.49	0.53	0.53	0.53	0.53	0.61	0.68	0.68	0.68	ns
DIFF_SSTL18_I_DCI_M	0.43	0.48	0.55	0.55	0.55	0.50	0.55	0.59	0.59	0.59	0.59	0.68	0.76	0.76	0.76	ns
DIFF_SSTL18_I_DCI_S	0.43	0.48	0.55	0.55	0.55	0.56	0.62	0.67	0.67	0.67	0.67	0.77	0.86	0.86	0.86	ns
DIFF_SSTL18_I_F	0.43	0.48	0.55	0.55	0.55	0.45	0.49	0.53	0.53	0.53	0.53	0.61	0.68	0.68	0.68	ns
DIFF_SSTL18_I_M	0.43	0.48	0.55	0.55	0.55	0.50	0.55	0.59	0.59	0.59	0.59	0.68	0.76	0.76	0.76	ns
DIFF_SSTL18_I_S	0.43	0.48	0.55	0.55	0.55	0.56	0.62	0.67	0.67	0.67	0.67	0.77	0.86	0.86	0.86	ns
HSLVDCI_15_F	0.43	0.46	0.52	0.52	0.52	0.48	0.53	0.56	0.56	0.56	0.57	0.64	0.71	0.71	0.71	ns
HSLVDCI_15_M	0.43	0.46	0.52	0.52	0.52	0.53	0.57	0.62	0.62	0.62	0.62	0.71	0.79	0.79	0.79	ns
HSLVDCI_15_S	0.43	0.46	0.52	0.52	0.52	0.58	0.64	0.69	0.69	0.69	0.70	0.79	0.88	0.88	0.88	ns
HSLVDCI_18_F	0.43	0.46	0.52	0.52	0.52	0.48	0.53	0.57	0.57	0.57	0.57	0.65	0.71	0.71	0.71	ns
HSLVDCI_18_M	0.43	0.46	0.52	0.52	0.52	0.52	0.57	0.62	0.62	0.62	0.62	0.71	0.79	0.79	0.79	ns
HSLVDCI_18_S	0.43	0.46	0.52	0.52	0.52	0.58	0.64	0.69	0.69	0.69	0.70	0.80	0.90	0.90	0.90	ns
HSTL_I_12_F	0.43	0.46	0.52	0.52	0.52	0.48	0.52	0.56	0.56	0.56	0.56	0.63	0.70	0.70	0.70	ns
HSTL_I_12_M	0.43	0.46	0.52	0.52	0.52	0.52	0.57	0.61	0.61	0.61	0.61	0.70	0.78	0.78	0.78	ns
HSTL_I_12_S	0.43	0.46	0.52	0.52	0.52	0.57	0.63	0.68	0.68	0.68	0.69	0.78	0.87	0.87	0.87	ns
HSTL_I_18_F	0.43	0.46	0.52	0.52	0.52	0.47	0.51	0.55	0.55	0.55	0.55	0.63	0.70	0.70	0.70	ns
HSTL_I_18_M	0.43	0.46	0.52	0.52	0.52	0.52	0.57	0.61	0.61	0.61	0.61	0.70	0.78	0.78	0.78	ns
HSTL_I_18_S	0.43	0.46	0.52	0.52	0.52	0.58	0.63	0.69	0.69	0.69	0.69	0.78	0.88	0.88	0.88	ns
HSTL_I_DCI_12_F	0.43	0.46	0.52	0.52	0.52	0.48	0.52	0.56	0.56	0.56	0.56	0.63	0.70	0.70	0.70	ns
HSTL_I_DCI_12_M	0.43	0.46	0.52	0.52	0.52	0.52	0.57	0.61	0.61	0.61	0.61	0.70	0.78	0.78	0.78	ns
HSTL_I_DCI_12_S	0.43	0.46	0.52	0.52	0.52	0.57	0.63	0.68	0.68	0.68	0.69	0.78	0.87	0.87	0.87	ns
HSTL_I_DCI_18_F	0.43	0.46	0.52	0.52	0.52	0.47	0.51	0.55	0.55	0.55	0.55	0.63	0.70	0.70	0.70	ns
HSTL_I_DCI_18_M	0.43	0.46	0.52	0.52	0.52	0.52	0.57	0.61	0.61	0.61	0.61	0.70	0.78	0.78	0.78	ns
HSTL_I_DCI_18_S	0.43	0.46	0.52	0.52	0.52	0.58	0.63	0.69	0.69	0.69	0.69	0.78	0.88	0.88	0.88	ns
HSTL_I_DCI_F	0.43	0.46	0.52	0.52	0.52	0.47	0.52	0.56	0.56	0.56	0.56	0.63	0.70	0.70	0.70	ns
HSTL_I_DCI_M	0.43	0.46	0.52	0.52	0.52	0.52	0.57	0.61	0.61	0.61	0.61	0.70	0.78	0.78	0.78	ns



Table 28: IOB High Performance (HP) Switching Characteristics (Cont'd)

I/O Standards	T _{INBUF_DELAY_PAD_I}					T _{OUTBUF_DELAY_O_PAD}					T _{OUTBUF_DELAY_TD_PAD}					Units
	1.0V	0.95V			0.9V	1.0V	0.95V			0.9V	1.0V	0.95V			0.9V	
	-3	-2	-1/-1L	-1M	-1L	-3	-2	-1/-1L	-1M	-1L	-3	-2	-1/-1L	-1M	-1L	
HSTL_I_DCI_S	0.43	0.46	0.52	0.52	0.52	0.57	0.63	0.68	0.68	0.68	0.69	0.78	0.87	0.87	0.87	ns
HSTL_I_F	0.43	0.46	0.52	0.52	0.52	0.47	0.52	0.56	0.56	0.56	0.56	0.63	0.70	0.70	0.70	ns
HSTL_I_M	0.43	0.46	0.52	0.52	0.52	0.52	0.57	0.61	0.61	0.61	0.61	0.70	0.78	0.78	0.78	ns
HSTL_I_S	0.43	0.46	0.52	0.52	0.52	0.57	0.63	0.68	0.68	0.68	0.69	0.78	0.87	0.87	0.87	ns
HSUL_12_DCI_F	0.43	0.46	0.52	0.52	0.52	0.48	0.52	0.56	0.56	0.56	0.56	0.63	0.70	0.70	0.70	ns
HSUL_12_DCI_M	0.43	0.46	0.52	0.52	0.52	0.52	0.57	0.61	0.61	0.61	0.61	0.70	0.78	0.78	0.78	ns
HSUL_12_DCI_S	0.43	0.46	0.52	0.52	0.52	0.57	0.63	0.68	0.68	0.68	0.69	0.78	0.87	0.87	0.87	ns
HSUL_12_F	0.43	0.46	0.52	0.52	0.52	0.48	0.52	0.56	0.56	0.56	0.56	0.63	0.70	0.70	0.70	ns
HSUL_12_M	0.43	0.46	0.52	0.52	0.52	0.52	0.57	0.61	0.61	0.61	0.61	0.70	0.78	0.78	0.78	ns
HSUL_12_S	0.43	0.46	0.52	0.52	0.52	0.57	0.63	0.68	0.68	0.68	0.69	0.78	0.87	0.87	0.87	ns
LVC MOS12_F_2	0.56	0.66	0.74	0.76	0.74	0.67	0.73	0.79	0.79	0.79	0.67	0.73	0.79	0.79	0.79	ns
LVC MOS12_F_4	0.56	0.66	0.74	0.76	0.74	0.63	0.68	0.73	0.73	0.73	0.63	0.68	0.73	0.73	0.73	ns
LVC MOS12_F_6	0.56	0.66	0.74	0.76	0.74	0.59	0.64	0.69	0.69	0.69	0.59	0.65	0.72	0.72	0.72	ns
LVC MOS12_F_8	0.56	0.66	0.74	0.76	0.74	0.57	0.63	0.67	0.67	0.67	0.59	0.66	0.72	0.72	0.72	ns
LVC MOS12_M_2	0.56	0.66	0.74	0.76	0.74	0.72	0.79	0.85	0.85	0.85	0.72	0.79	0.85	0.85	0.85	ns
LVC MOS12_M_4	0.56	0.66	0.74	0.76	0.74	0.66	0.71	0.77	0.77	0.77	0.66	0.71	0.77	0.77	0.77	ns
LVC MOS12_M_6	0.56	0.66	0.74	0.76	0.74	0.62	0.67	0.72	0.72	0.72	0.62	0.69	0.75	0.75	0.75	ns
LVC MOS12_M_8	0.56	0.66	0.74	0.76	0.74	0.62	0.67	0.72	0.72	0.72	0.64	0.71	0.78	0.78	0.78	ns
LVC MOS12_S_2	0.56	0.66	0.74	0.76	0.74	0.77	0.89	0.96	0.96	0.96	0.77	0.89	0.96	0.96	0.96	ns
LVC MOS12_S_4	0.56	0.66	0.74	0.76	0.74	0.68	0.74	0.79	0.79	0.79	0.68	0.74	0.79	0.79	0.79	ns
LVC MOS12_S_6	0.56	0.66	0.74	0.76	0.74	0.66	0.72	0.78	0.78	0.78	0.66	0.72	0.79	0.79	0.79	ns
LVC MOS12_S_8	0.56	0.66	0.74	0.76	0.74	0.66	0.72	0.77	0.77	0.77	0.67	0.74	0.82	0.82	0.82	ns
LVC MOS15_F_12	0.45	0.52	0.58	0.60	0.58	0.61	0.66	0.71	0.71	0.71	0.66	0.73	0.81	0.81	0.81	ns
LVC MOS15_F_2	0.45	0.52	0.58	0.60	0.58	0.73	0.77	0.83	0.83	0.83	0.73	0.77	0.83	0.83	0.83	ns
LVC MOS15_F_4	0.45	0.52	0.58	0.60	0.58	0.69	0.73	0.78	0.78	0.78	0.69	0.73	0.78	0.78	0.78	ns
LVC MOS15_F_6	0.45	0.52	0.58	0.60	0.58	0.63	0.68	0.73	0.73	0.73	0.63	0.70	0.77	0.77	0.77	ns
LVC MOS15_F_8	0.45	0.52	0.58	0.60	0.58	0.61	0.66	0.72	0.72	0.72	0.63	0.71	0.78	0.78	0.78	ns
LVC MOS15_M_12	0.45	0.52	0.58	0.60	0.58	0.63	0.69	0.75	0.75	0.75	0.67	0.77	0.85	0.85	0.85	ns
LVC MOS15_M_2	0.45	0.52	0.58	0.60	0.58	0.77	0.80	0.86	0.86	0.86	0.77	0.80	0.86	0.86	0.86	ns
LVC MOS15_M_4	0.45	0.52	0.58	0.60	0.58	0.72	0.76	0.82	0.82	0.82	0.72	0.76	0.82	0.82	0.82	ns
LVC MOS15_M_6	0.45	0.52	0.58	0.60	0.58	0.67	0.72	0.78	0.78	0.78	0.67	0.74	0.82	0.82	0.82	ns
LVC MOS15_M_8	0.45	0.52	0.58	0.60	0.58	0.65	0.71	0.76	0.76	0.76	0.65	0.76	0.83	0.83	0.83	ns
LVC MOS15_S_12	0.45	0.52	0.58	0.60	0.58	0.65	0.70	0.75	0.75	0.75	0.67	0.75	0.83	0.83	0.83	ns
LVC MOS15_S_2	0.45	0.52	0.58	0.60	0.58	0.78	0.85	0.91	0.91	0.91	0.78	0.85	0.91	0.91	0.91	ns
LVC MOS15_S_4	0.45	0.52	0.58	0.60	0.58	0.74	0.78	0.84	0.84	0.84	0.74	0.78	0.84	0.84	0.84	ns
LVC MOS15_S_6	0.45	0.52	0.58	0.60	0.58	0.72	0.76	0.82	0.82	0.82	0.72	0.76	0.84	0.84	0.84	ns
LVC MOS15_S_8	0.45	0.52	0.58	0.60	0.58	0.68	0.73	0.79	0.79	0.79	0.68	0.75	0.83	0.83	0.83	ns
LVC MOS18_F_12	0.43	0.49	0.54	0.55	0.54	0.67	0.72	0.78	0.78	0.78	0.67	0.81	0.90	0.90	0.90	ns
LVC MOS18_F_2	0.43	0.49	0.54	0.55	0.54	0.94	1.07	1.15	1.15	1.15	0.94	1.07	1.15	1.15	1.15	ns
LVC MOS18_F_4	0.43	0.49	0.54	0.55	0.54	0.78	0.82	0.89	0.89	0.89	0.78	0.82	0.89	0.89	0.89	ns



Table 28: IOB High Performance (HP) Switching Characteristics (Cont'd)

I/O Standards	T _{INBUF_DELAY_PAD_I}					T _{OUTBUF_DELAY_O_PAD}					T _{OUTBUF_DELAY_TD_PAD}					Units
	1.0V	0.95V			0.9V	1.0V	0.95V			0.9V	1.0V	0.95V			0.9V	
	-3	-2	-1/-1L	-1M	-1L	-3	-2	-1/-1L	-1M	-1L	-3	-2	-1/-1L	-1M	-1L	
LVC MOS18_F_6	0.43	0.49	0.54	0.55	0.54	0.72	0.77	0.83	0.83	0.83	0.72	0.79	0.88	0.88	0.88	ns
LVC MOS18_F_8	0.43	0.49	0.54	0.55	0.54	0.70	0.75	0.81	0.81	0.81	0.72	0.81	0.89	0.89	0.89	ns
LVC MOS18_M_12	0.43	0.49	0.54	0.55	0.54	0.70	0.76	0.81	0.81	0.81	0.74	0.83	0.92	0.92	0.92	ns
LVC MOS18_M_2	0.43	0.49	0.54	0.55	0.54	0.99	1.10	1.19	1.19	1.19	0.99	1.10	1.19	1.19	1.19	ns
LVC MOS18_M_4	0.43	0.49	0.54	0.55	0.54	0.82	0.86	0.92	0.92	0.92	0.82	0.86	0.92	0.92	0.92	ns
LVC MOS18_M_6	0.43	0.49	0.54	0.55	0.54	0.75	0.80	0.87	0.87	0.87	0.75	0.81	0.90	0.90	0.90	ns
LVC MOS18_M_8	0.43	0.49	0.54	0.55	0.54	0.73	0.78	0.85	0.85	0.85	0.73	0.83	0.92	0.92	0.92	ns
LVC MOS18_S_12	0.43	0.49	0.54	0.55	0.54	0.74	0.78	0.84	0.84	0.84	0.76	0.83	0.92	0.92	0.92	ns
LVC MOS18_S_2	0.43	0.49	0.54	0.55	0.54	1.05	1.16	1.25	1.25	1.25	1.05	1.16	1.25	1.25	1.25	ns
LVC MOS18_S_4	0.43	0.49	0.54	0.55	0.54	0.83	0.86	0.93	0.93	0.93	0.83	0.86	0.93	0.93	0.93	ns
LVC MOS18_S_6	0.43	0.49	0.54	0.55	0.54	0.79	0.82	0.89	0.89	0.89	0.79	0.82	0.90	0.90	0.90	ns
LVC MOS18_S_8	0.43	0.49	0.54	0.55	0.54	0.75	0.80	0.86	0.86	0.86	0.75	0.82	0.90	0.90	0.90	ns
LVDCI_15_F	0.45	0.52	0.58	0.60	0.58	0.48	0.53	0.56	0.56	0.56	0.57	0.64	0.71	0.71	0.71	ns
LVDCI_15_M	0.45	0.52	0.58	0.60	0.58	0.53	0.57	0.62	0.62	0.62	0.62	0.71	0.79	0.79	0.79	ns
LVDCI_15_S	0.45	0.52	0.58	0.60	0.58	0.58	0.64	0.69	0.69	0.69	0.70	0.79	0.88	0.88	0.88	ns
LVDCI_18_F	0.43	0.49	0.54	0.55	0.54	0.48	0.53	0.57	0.57	0.57	0.57	0.65	0.71	0.71	0.71	ns
LVDCI_18_M	0.43	0.49	0.54	0.55	0.54	0.52	0.57	0.62	0.62	0.62	0.62	0.71	0.79	0.79	0.79	ns
LVDCI_18_S	0.43	0.49	0.54	0.55	0.54	0.58	0.64	0.69	0.69	0.69	0.70	0.80	0.90	0.90	0.90	ns
LVDS	0.42	0.46	0.51	0.51	0.51	0.57	0.67	0.72	0.72	0.72	890.24	890.26	890.28	890.28	890.28	ns
POD10_DCI_F	0.43	0.46	0.52	0.52	0.52	0.48	0.52	0.56	0.56	0.56	0.59	0.67	0.74	0.74	0.74	ns
POD10_DCI_M	0.43	0.46	0.52	0.52	0.52	0.54	0.60	0.65	0.65	0.65	0.64	0.73	0.81	0.81	0.81	ns
POD10_DCI_S	0.43	0.46	0.52	0.52	0.52	0.63	0.69	0.76	0.76	0.76	0.71	0.81	0.89	0.89	0.89	ns
POD10_F	0.43	0.46	0.52	0.52	0.52	0.48	0.52	0.56	0.56	0.56	0.59	0.67	0.74	0.74	0.74	ns
POD10_M	0.43	0.46	0.52	0.52	0.52	0.54	0.60	0.65	0.65	0.65	0.64	0.73	0.81	0.81	0.81	ns
POD10_S	0.43	0.46	0.52	0.52	0.52	0.63	0.69	0.76	0.76	0.76	0.71	0.81	0.89	0.89	0.89	ns
POD12_DCI_F	0.43	0.46	0.52	0.52	0.52	0.48	0.52	0.56	0.56	0.56	0.59	0.67	0.74	0.74	0.74	ns
POD12_DCI_M	0.43	0.46	0.52	0.52	0.52	0.54	0.60	0.65	0.65	0.65	0.64	0.73	0.81	0.81	0.81	ns
POD12_DCI_S	0.43	0.46	0.52	0.52	0.52	0.63	0.69	0.76	0.76	0.76	0.71	0.81	0.89	0.89	0.89	ns
POD12_F	0.43	0.46	0.52	0.52	0.52	0.48	0.52	0.56	0.56	0.56	0.59	0.67	0.74	0.74	0.74	ns
POD12_M	0.43	0.46	0.52	0.52	0.52	0.54	0.60	0.65	0.65	0.65	0.64	0.73	0.81	0.81	0.81	ns
POD12_S	0.43	0.46	0.52	0.52	0.52	0.63	0.69	0.76	0.76	0.76	0.71	0.81	0.89	0.89	0.89	ns
SLVS_400_18	0.42	0.46	0.51	0.51	0.51	N/A	N/A	N/A	N/A	N/A	N/A	N/A	N/A	N/A	N/A	ns
SSTL12_DCI_F	0.43	0.46	0.52	0.52	0.52	0.48	0.52	0.56	0.56	0.56	0.56	0.63	0.70	0.70	0.70	ns
SSTL12_DCI_M	0.43	0.46	0.52	0.52	0.52	0.52	0.57	0.61	0.61	0.61	0.61	0.70	0.78	0.78	0.78	ns
SSTL12_DCI_S	0.43	0.46	0.52	0.52	0.52	0.57	0.63	0.68	0.68	0.68	0.69	0.78	0.87	0.87	0.87	ns
SSTL12_F	0.43	0.46	0.52	0.52	0.52	0.48	0.52	0.56	0.56	0.56	0.56	0.63	0.70	0.70	0.70	ns
SSTL12_M	0.43	0.46	0.52	0.52	0.52	0.52	0.57	0.61	0.61	0.61	0.61	0.70	0.78	0.78	0.78	ns
SSTL12_S	0.43	0.46	0.52	0.52	0.52	0.57	0.63	0.68	0.68	0.68	0.69	0.78	0.87	0.87	0.87	ns
SSTL135_DCI_F	0.43	0.46	0.52	0.52	0.52	0.48	0.52	0.56	0.56	0.56	0.56	0.64	0.70	0.70	0.70	ns
SSTL135_DCI_M	0.43	0.46	0.52	0.52	0.52	0.52	0.57	0.61	0.61	0.61	0.61	0.70	0.78	0.78	0.78	ns



Table 28: IOB High Performance (HP) Switching Characteristics (Cont'd)

I/O Standards	$T_{\text{INBUF_DELAY_PAD_I}}$					$T_{\text{OUTBUF_DELAY_O_PAD}}$					$T_{\text{OUTBUF_DELAY_TD_PAD}}$					Units
	1.0V		0.95V		0.9V	1.0V		0.95V		0.9V	1.0V		0.95V		0.9V	
	-3	-2	-1/-1L	-1M	-1L	-3	-2	-1/-1L	-1M	-1L	-3	-2	-1/-1L	-1M	-1L	
SSTL135_DCI_S	0.43	0.46	0.52	0.52	0.52	0.57	0.63	0.68	0.68	0.68	0.69	0.78	0.87	0.87	0.87	ns
SSTL135_F	0.43	0.46	0.52	0.52	0.52	0.48	0.52	0.56	0.56	0.56	0.56	0.64	0.70	0.70	0.70	ns
SSTL135_M	0.43	0.46	0.52	0.52	0.52	0.52	0.57	0.61	0.61	0.61	0.61	0.70	0.78	0.78	0.78	ns
SSTL135_S	0.43	0.46	0.52	0.52	0.52	0.57	0.63	0.68	0.68	0.68	0.69	0.78	0.87	0.87	0.87	ns
SSTL15_DCI_F	0.43	0.46	0.52	0.52	0.52	0.47	0.52	0.56	0.56	0.56	0.56	0.63	0.70	0.70	0.70	ns
SSTL15_DCI_M	0.43	0.46	0.52	0.52	0.52	0.52	0.57	0.61	0.61	0.61	0.61	0.70	0.78	0.78	0.78	ns
SSTL15_DCI_S	0.43	0.46	0.52	0.52	0.52	0.57	0.63	0.68	0.68	0.68	0.69	0.78	0.87	0.87	0.87	ns
SSTL15_F	0.43	0.46	0.52	0.52	0.52	0.47	0.52	0.56	0.56	0.56	0.56	0.63	0.70	0.70	0.70	ns
SSTL15_M	0.43	0.46	0.52	0.52	0.52	0.52	0.57	0.61	0.61	0.61	0.61	0.70	0.78	0.78	0.78	ns
SSTL15_S	0.43	0.46	0.52	0.52	0.52	0.57	0.63	0.68	0.68	0.68	0.69	0.78	0.87	0.87	0.87	ns
SSTL18_I_DCI_F	0.43	0.46	0.52	0.52	0.52	0.47	0.51	0.55	0.55	0.55	0.55	0.63	0.70	0.70	0.70	ns
SSTL18_I_DCI_M	0.43	0.46	0.52	0.52	0.52	0.52	0.57	0.61	0.61	0.61	0.61	0.70	0.78	0.78	0.78	ns
SSTL18_I_DCI_S	0.43	0.46	0.52	0.52	0.52	0.58	0.63	0.69	0.69	0.69	0.69	0.78	0.88	0.88	0.88	ns
SSTL18_I_F	0.43	0.46	0.52	0.52	0.52	0.47	0.51	0.55	0.55	0.55	0.55	0.63	0.70	0.70	0.70	ns
SSTL18_I_M	0.43	0.46	0.52	0.52	0.52	0.52	0.57	0.61	0.61	0.61	0.61	0.70	0.78	0.78	0.78	ns
SSTL18_I_S	0.43	0.46	0.52	0.52	0.52	0.58	0.63	0.69	0.69	0.69	0.69	0.78	0.88	0.88	0.88	ns
SUB_LVDS	0.42	0.46	0.51	0.51	0.51	0.57	0.67	0.72	0.72	0.72	890.24	890.26	890.28	890.28	890.28	ns

Table 29 specifies the values of $T_{\text{OUTBUF_DELAY_TE_PAD}}$ and $T_{\text{INBUF_DELAY_IBUFDIS_O}}$. $T_{\text{OUTBUF_DELAY_TE_PAD}}$ is the delay from the T pin to the IOB pad through the output buffer of an IOB pad, when 3-state is enabled (i.e., a high impedance state). $T_{\text{INBUF_DELAY_IBUFDIS_O}}$ is the IOB delay from IBUFDISABLE to O output. In HP I/O banks, the internal DCI termination turn-off time is always faster than $T_{\text{OUTBUF_DELAY_TE_PAD}}$ when the DCITERMDISABLE pin is used. In HR I/O banks, the internal IN_TERM termination turn-off time is always faster than $T_{\text{OUTBUF_DELAY_TE_PAD}}$ when the INTERMDISABLE pin is used.

Table 29: IOB 3-state Output Switching Characteristics

Symbol	Description	Speed Grade and V_{CCIINT} Operating Voltages				Units	
		1.0V		0.95V			0.90V
		-3	-2	-1/-1L	-1L		
$T_{\text{OUTBUF_DELAY_TE_PAD}}^{(1)}$	T input to pad high-impedance for HR I/O banks	1.37	1.52	1.69	1.69	ns	
	T input to pad high-impedance for HP I/O banks	0.62	0.71	0.78	0.78	ns	
$T_{\text{INBUF_DELAY_IBUFDIS_O}}$	IBUF turn-on time from IBUFDISABLE to O output for HR I/O banks	0.47	0.65	0.68	0.68	ns	
	IBUF turn-on time from IBUFDISABLE to O output for HP I/O banks	1.06	1.21	1.49	1.49	ns	

Notes:

- The $T_{\text{OUTBUF_DELAY_TE_PAD}}$ values are applicable to single-ended I/O standards. For true differential standards, the values are larger. Use the Vivado timing report for the most accurate timing values for your configuration.



I/O Standard Adjustment Measurement Methodology

Input Delay Measurements

Table 30 shows the test setup parameters used for measuring input delay.

Table 30: Input Delay Measurement Methodology

Description	I/O Standard Attribute	$V_L^{(1)(2)}$	$V_H^{(1)(2)}$	$V_{MEAS}^{(1)(4)(6)}$	$V_{REF}^{(1)(3)(5)}$
LVC MOS, 1.2V	LVC MOS12	0.1	1.1	0.6	–
LVC MOS, LVDCI, HSLVDCI, 1.5V	LVC MOS15, LVDCI_15, HSLVDCI_15	0.1	1.4	0.75	–
LVC MOS, LVDCI, HSLVDCI, 1.8V	LVC MOS18, LVDCI_18, HSLVDCI_18	0.1	1.7	0.9	–
LVC MOS, 2.5V	LVC MOS25	0.1	2.4	1.25	–
LVC MOS, 3.3V	LVC MOS33	0.1	3.2	1.65	–
LV TTL, 3.3V	LV TTL	0.1	3.2	1.65	–
HSTL (high-speed transceiver logic), Class I, 1.2V	HSTL_I_12	$V_{REF} - 0.5$	$V_{REF} + 0.5$	V_{REF}	0.60
HSTL, Class I and II, 1.5V	HSTL_I, HSTL_II	$V_{REF} - 0.65$	$V_{REF} + 0.65$	V_{REF}	0.75
HSTL, Class I and II, 1.8V	HSTL_I_18, HSTL_II_18	$V_{REF} - 0.8$	$V_{REF} + 0.8$	V_{REF}	0.90
HSUL (high-speed unterminated logic), 1.2V	HSUL_12	$V_{REF} - 0.5$	$V_{REF} + 0.5$	V_{REF}	0.60
SSTL (stub series terminated logic), 1.2V	SSTL12	$V_{REF} - 0.5$	$V_{REF} + 0.5$	V_{REF}	0.60
SSTL, 1.35V	SSTL135, SSTL135_R	$V_{REF} - 0.575$	$V_{REF} + 0.575$	V_{REF}	0.675
SSTL, 1.5V	SSTL15, SSTL15_R	$V_{REF} - 0.65$	$V_{REF} + 0.65$	V_{REF}	0.75
SSTL, Class I and II, 1.8V	SSTL18_I, SSTL18_II	$V_{REF} - 0.8$	$V_{REF} + 0.8$	V_{REF}	0.90
POD10, 1.0V	POD10	$V_{REF} - 0.6$	$V_{REF} + 0.6$	V_{REF}	0.70
POD12, 1.2V	POD12	$V_{REF} - 0.74$	$V_{REF} + 0.74$	V_{REF}	0.84
DIFF_HSTL, Class I, 1.2V	DIFF_HSTL_I_12	$0.6 - 0.125$	$0.6 + 0.125$	$0^{(6)}$	–
DIFF_HSTL, Class I and II, 1.5V	DIFF_HSTL_I, DIFF_HSTL_II	$0.75 - 0.125$	$0.75 + 0.125$	$0^{(6)}$	–
DIFF_HSTL, Class I and II, 1.8V	DIFF_HSTL_I_18, DIFF_HSTL_II_18	$0.9 - 0.125$	$0.9 + 0.125$	$0^{(6)}$	–
DIFF_HSUL, 1.2V	DIFF_HSUL_12	$0.6 - 0.125$	$0.6 + 0.125$	$0^{(6)}$	–
DIFF_SSTL, 1.2V	DIFF_SSTL12	$0.6 - 0.125$	$0.6 + 0.125$	$0^{(6)}$	–
DIFF_SSTL135/DIFF_SSTL135_R, 1.35V	DIFF_SSTL135, DIFF_SSTL135_R	$0.675 - 0.125$	$0.675 + 0.125$	$0^{(6)}$	–
DIFF_SSTL15/DIFF_SSTL15_R, 1.5V	DIFF_SSTL15, DIFF_SSTL15_R	$0.75 - 0.125$	$0.75 + 0.125$	$0^{(6)}$	–
DIFF_SSTL18_I/DIFF_SSTL18_II, 1.8V	DIFF_SSTL18_I, DIFF_SSTL18_II	$0.9 - 0.125$	$0.9 + 0.125$	$0^{(6)}$	–
DIFF_POD10, 1.0V	DIFF_POD10	$0.70 - 0.125$	$0.70 + 0.125$	$0^{(6)}$	–
DIFF_POD12, 1.2V	DIFF_POD12	$0.84 - 0.125$	$0.84 + 0.125$	$0^{(6)}$	–



Table 30: Input Delay Measurement Methodology (Cont'd)

Description	I/O Standard Attribute	$V_L^{(1)(2)}$	$V_H^{(1)(2)}$	$V_{MEAS}^{(1)(4)(6)}$	$V_{REF}^{(1)(3)(5)}$
LVDS (low-voltage differential signaling), 1.8V	LVDS	0.9 – 0.125	0.9 + 0.125	0 ⁽⁶⁾	–
LVDS_25, 2.5V	LVDS_25	1.25 – 0.125	1.25 + 0.125	0 ⁽⁶⁾	–
SUB_LVDS, 1.8V	SUB_LVDS	0.9 – 0.125	0.9 + 0.125	0 ⁽⁶⁾	–
SLVS, 1.8V	SLVS_400_18	0.9 – 0.125	0.9 + 0.125	0 ⁽⁶⁾	–
SLVS, 2.5V	SLVS_400_25	1.25 – 0.125	1.25 + 0.125	0 ⁽⁶⁾	–
LVPECL, 2.5	LVPECL	1.25 – 0.125	1.25 + 0.125	0 ⁽⁶⁾	–
BLVDS_25, 2.5V	BLVDS_25	1.25 – 0.125	1.25 + 0.125	0 ⁽⁶⁾	–
MINI_LVDS_25, 2.5V	MINI_LVDS_25	1.25 – 0.125	1.25 + 0.125	0 ⁽⁶⁾	–
PPDS_25	PPDS_25	1.25 – 0.125	1.25 + 0.125	0 ⁽⁶⁾	–
RSDS_25	RSDS_25	1.25 – 0.125	1.25 + 0.125	0 ⁽⁶⁾	–
TMDS_33	TMDS_33	3 – 0.125	3 + 0.125	0 ⁽⁶⁾	–

Notes:

1. The input delay measurement methodology parameters for LVDCI are the same for LVCMOS standards of the same voltage. Input delay measurement methodology parameters for HSLVDCI are the same as for HSTL_II standards of the same voltage. Parameters for all other DCI standards are the same for the corresponding non-DCI standards.
2. Input waveform switches between V_L and V_H .
3. Measurements are made at typical, minimum, and maximum V_{REF} values. Reported delays reflect worst case of these measurements. V_{REF} values listed are typical.
4. Input voltage level from which measurement starts.
5. This is an input voltage reference that bears no relation to the V_{REF}/V_{MEAS} parameters found in IBIS models and/or noted in [Figure 1](#).
6. The value given is the differential input voltage.

Output Delay Measurements

Output delays are measured with short output traces. Standard termination was used for all testing. The propagation delay of the trace is characterized separately and subtracted from the final measurement, and is therefore not included in the generalized test setups shown in [Figure 1](#) and [Figure 2](#).

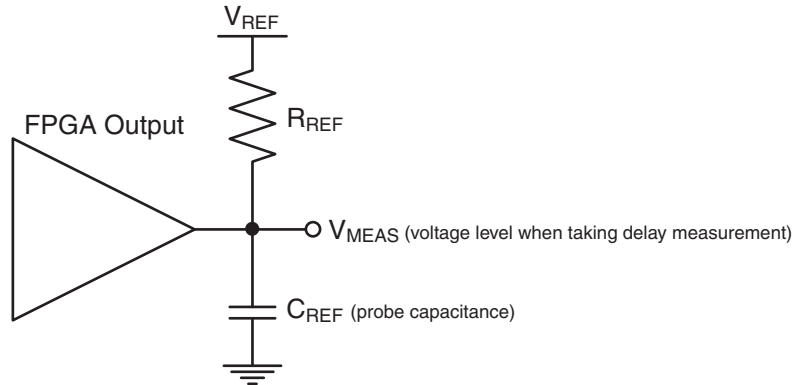

DS892_01_120414

Figure 1: Single-Ended Test Setup

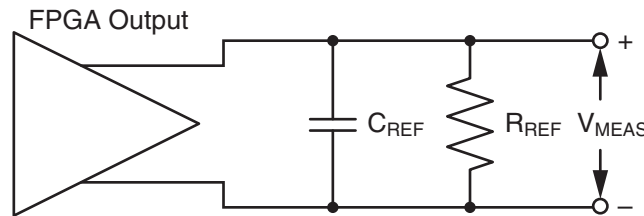

DS892_02_120414

Figure 2: Differential Test Setup

Parameters V_{REF} , R_{REF} , C_{REF} , and V_{MEAS} fully describe the test conditions for each I/O standard. The most accurate prediction of propagation delay in any given application can be obtained through IBIS simulation, using this method:

1. Simulate the output driver of choice into the generalized test setup using values from [Table 31](#).
2. Record the time to V_{MEAS} .
3. Simulate the output driver of choice into the actual PCB trace and load using the appropriate IBIS model or capacitance value to represent the load.
4. Record the time to V_{MEAS} .
5. Compare the results of [step 2](#) and [step 4](#). The increase or decrease in delay yields the actual propagation delay of the PCB trace.



Table 31: Output Delay Measurement Methodology

Description	I/O Standard Attribute	R _{REF} (Ω)	C _{REF} ⁽¹⁾ (pF)	V _{MEAS} (V)	V _{REF} (V)
LVC MOS, 1.2V	LVC MOS12	1M	0	0.6	0
LVC MOS 1.5V	LVC MOS15	1M	0	0.75	0
LVC MOS 1.8V	LVC MOS18	1M	0	0.9	0
LVC MOS, 2.5V	LVC MOS25	1M	0	1.25	0
LVC MOS, 3.3V	LVC MOS33	1M	0	1.65	0
LVTTL, 3.3V	LVTTL	1M	0	1.65	0
LVDCI/HSLVDCI, 1.5V	LVDCI_15, HSLVDCI_15	50	0	V _{REF}	0.75
LVDCI/HSLVDCI, 1.8V	LVDCI_18, HSLVDCI_18	50	0	V _{REF}	0.9
HSTL (high-speed transceiver logic), Class I, 1.2V	HSTL_I_12	50	0	V _{REF}	0.6
HSTL, Class I, 1.5V	HSTL_I	50	0	V _{REF}	0.75
HSTL, Class II, 1.5V	HSTL_II	25	0	V _{REF}	0.75
HSTL, Class I, 1.8V	HSTL_I_18	50	0	V _{REF}	0.9
HSTL, Class II, 1.8V	HSTL_II_18	25	0	V _{REF}	0.9
HSUL (high-speed unterminated logic), 1.2V	HSUL_12	50	0	V _{REF}	0.6
SSTL12, 1.2V	SSTL12	50	0	V _{REF}	0.6
SSTL135/SSTL135_R, 1.35V	SSTL135, SSTL135_R	50	0	V _{REF}	0.675
SSTL15/SSTL15_R, 1.5V	SSTL15, SSTL15_R	50	0	V _{REF}	0.75
SSTL (stub series terminated logic), Class I and Class II, 1.8V	SSTL18_I, SSTL18_II	50	0	V _{REF}	0.9
POD10, 1.0V	POD10	50	0	V _{REF}	1.0
POD12, 1.2V	POD12	50	0	V _{REF}	1.2
DIFF_HSTL, Class I, 1.2V	DIFF_HSTL_I_12	50	0	V _{REF}	0.6
DIFF_HSTL, Class I and II, 1.5V	DIFF_HSTL_I, DIFF_HSTL_II	50	0	V _{REF}	0.75
DIFF_HSTL, Class I and II, 1.8V	DIFF_HSTL_I_18, DIFF_HSTL_II_18	50	0	V _{REF}	0.9
DIFF_HSUL_12, 1.2V	DIFF_HSUL_12	50	0	V _{REF}	0.6
DIFF_SSTL12, 1.2V	DIFF_SSTL12	50	0	V _{REF}	0.6
DIFF_SSTL135/DIFF_SSTL135_R, 1.35V	DIFF_SSTL135, DIFF_SSTL135_R	50	0	V _{REF}	0.675
DIFF_SSTL15/DIFF_SSTL15_R, 1.5V	DIFF_SSTL15, DIFF_SSTL15_R	50	0	V _{REF}	0.75
DIFF_SSTL18, Class I and II, 1.8V	DIFF_SSTL18_I, DIFF_SSTL18_II	50	0	V _{REF}	0.9
DIFF_POD10, 1.0V	DIFF_POD10	50	0	V _{REF}	1.0
DIFF_POD12, 1.2V	DIFF_POD12	50	0	V _{REF}	1.2
LVDS (low-voltage differential signaling), 1.8V	LVDS	100	0	0 ⁽²⁾	0
LVDS, 2.5V	LVDS_25	100	0	0 ⁽²⁾	0
BLVDS (Bus LVDS), 2.5V	BLVDS_25	100	0	0 ⁽²⁾	0
Mini LVDS, 2.5V	MINI_LVDS_25	100	0	0 ⁽²⁾	0
PPDS_25	PPDS_25	100	0	0 ⁽²⁾	0
RS DS_25	RS DS_25	100	0	0 ⁽²⁾	0



Table 31: Output Delay Measurement Methodology (Cont'd)

Description	I/O Standard Attribute	R _{REF} (Ω)	C _{REF} ⁽¹⁾ (pF)	V _{MEAS} (V)	V _{REF} (V)
SUB_LVDS	SUB_LVDS	100	0	0 ⁽²⁾	0
TMDS_33	TMDS_33	50	0	0 ⁽²⁾	3.3

Notes:

- C_{REF} is the capacitance of the probe, nominally 0 pF.
- The value given is the differential output voltage.

Block RAM and FIFO Switching Characteristics

Table 32: Block RAM and FIFO Switching Characteristics

Symbol	Description	Speed Grade and V _{CCINT} Operating Voltages				Units
		1.0V	0.95V		0.90V	
		-3	-2	-1/-1L	-1L	
Maximum Frequency						
F _{MAX_WF_NC}	Block RAM (Write First and No Change modes)	660	585	525	525	MHz
F _{MAX_RF}	Block RAM (Read First mode)	575	510	460	400	MHz
F _{MAX_FIFO}	FIFO in all modes without ECC	660	585	525	525	MHz
F _{MAX_ECC}	Block RAM and FIFO in ECC configuration without PIPELINE	530	450	390	390	MHz
	Block RAM and FIFO in ECC configuration with PIPELINE and Block RAM in Write First or No Change mode.	660	585	525	525	MHz
	Block RAM in ECC configuration in Read First mode with PIPELINE	575	510	460	400	MHz
F _{MAX_ADDREN_RDADDRCHANGE}	Block RAM with address enable and read address change compare turned on	575	510	460	400	MHz
T _{PW_WF_NC} ⁽¹⁾	Block RAM in WRITE_FIRST and NO_CHANGE modes and FIFO. Clock High/Low pulse width	758	855	952	952	ps, Min
T _{PW_RF} ⁽¹⁾	Block RAM in READ_FIRST modes. Clock High/Low pulse width	870	980	1087	1250	ps, Min
Block RAM and FIFO Clock-to-Out Delays						
T _{RCKO_DO}	Clock CLK to DOUT output (without output register)	1.13	1.44	1.64	1.64	ns, Max
T _{RCKO_DO_REG}	Clock CLK to DOUT output (with output register)	0.37	0.44	0.49	0.49	ns, Max

Notes:

- The MMCM and PLL DUTY_CYCLE attribute should be set to 50% to meet the pulse width requirements at the higher frequencies.



Input/Output Delay Switching Characteristics

Table 33: Input/Output Delay Switching Characteristics

Symbol	Description	Speed Grade and V _{CCINT} Operating Voltages				Units
		1.0V	0.95V		0.90V	
		-3	-2	-1/-1L	-1L	
F _{REFCLK}	Reference clock frequency for IDELAYCTRL (in component mode)	200 to 800				MHz
	Reference clock frequency when using BITSlice_CONTROL with REFCLK (in native mode (for RX_BITSlice only))	200 to 800				MHz
	Reference clock frequency for BITSlice_CONTROL with PLL_CLK (in native mode) ⁽¹⁾	200 to 2400	200 to 2400	200 to 2133	200 to 2133	MHz
T _{MINPER_CLK}	Minimum period for IODELAY CLK	2.740	2.740	3.160	3.160	ns
T _{MINPER_RST}	Minimum reset pulse width	52.00				ns
T _{IDELAY_RESOLUTION} / T _{ODELAY_RESOLUTION}	IDELAY/ODELAY chain resolution	2.5 to 15				ps

Notes:

1. PLL settings could restrict the minimum allowable data rate. For example, when using a PLL with CLKOUTPHY_MODE = VCO_HALF, the minimum frequency is PLL_F_{VCOMIN}/2.

DSP48 Slice Switching Characteristics

Table 34: DSP48 Slice Switching Characteristics

Symbol	Description	Speed Grade and V _{CCINT} Operating Voltages				Units
		1.0V	0.95V		0.90V	
		-3	-2	-1/-1L	-1L	
Maximum Frequency						
F _{MAX}	With all registers used	741	661	594	594	MHz
F _{MAX_PATDET}	With pattern detector	687	581	512	512	MHz
F _{MAX_MULT_NOMREG}	Two register multiply without MREG	462	429	361	361	MHz
F _{MAX_MULT_NOMREG_PATDET}	Two register multiply without MREG with pattern detect	428	387	326	326	MHz
F _{MAX_PREADD_NOADREG}	Without ADREG	468	429	358	358	MHz
F _{MAX_NOPIPELINEREG}	Without pipeline registers (MREG, ADREG)	335	312	260	260	MHz
F _{MAX_NOPIPELINEREG_PATDET}	Without pipeline registers (MREG, ADREG) with pattern detect	316	286	238	238	MHz



Clock Buffers and Networks

Table 35: Clock Buffers Switching Characteristics

Symbol	Description	Speed Grade and V_{CCINT} Operating Voltages				Units
		1.0V	0.95V		0.90V	
		-3	-2	-1/-1L	-1L	
Global Clock Switching Characteristics (Including BUFGCTRL)						
F_{MAX}	Maximum frequency of a global clock tree (BUFG)	850	725	630	630	MHz
Global Clock Buffer with Input Divide Capability (BUFGCE_DIV)						
F_{MAX}	Maximum frequency of a global clock buffer with input divide capability (BUFGCE_DIV)	850	725	630	630	MHz
Global Clock Buffer with Clock Enable (BUFGCE)						
F_{MAX}	Maximum frequency of a global clock buffer with clock enable (BUFGCE)	850	725	630	630	MHz
Leaf Clock Buffer with Clock Enable (BUFCE_LEAF)						
F_{MAX}	Maximum frequency of a leaf clock buffer with clock enable (BUFCE_LEAF)	850	725	630	630	MHz
GTH/GTY Clock Buffer with Clock Enable and Clock Input Divide Capability (BUFG_GT)						
F_{MAX}	Maximum frequency of a serial transceiver clock buffer with clock enable and clock input divide capability	512	512	512	512	MHz



MMCM Switching Characteristics

Table 36: MMCM Specification

Symbol	Description	Speed Grade and V _{CCINT} Operating Voltages				Units
		1.0V	0.95V		0.90V	
		-3	-2	-1/-1L	-1L	
MMCM_F _{INMAX}	Maximum input clock frequency	1066	933	800	800	MHz
MMCM_F _{INMIN}	Minimum input clock frequency	10	10	10	10	MHz
MMCM_F _{INJITTER}	Maximum input clock period jitter	< 20% of clock input period or 1 ns Max				
MMCM_F _{INDUTY}	Input duty cycle range: 10–49 MHz	25–75				%
	Input duty cycle range: 50–199 MHz	30–70				%
	Input duty cycle range: 200–399 MHz	35–65				%
	Input duty cycle range: 400–499 MHz	40–60				%
	Input duty cycle range: >500 MHz	45–55				%
MMCM_F _{MIN_PSCLK}	Minimum dynamic phase shift clock frequency	0.01	0.01	0.01	0.01	MHz
MMCM_F _{MAX_PSCLK}	Maximum dynamic phase shift clock frequency	550	500	450	450	MHz
MMCM_F _{VCOMIN}	Minimum MMCM VCO frequency	600	600	600	600	MHz
MMCM_F _{VCOMAX}	Maximum MMCM VCO frequency	1600	1440	1200	1200	MHz
MMCM_F _{BANDWIDTH}	Low MMCM bandwidth at typical ⁽¹⁾	1.00	1.00	1.00	1.00	MHz
	High MMCM bandwidth at typical ⁽¹⁾	4.00	4.00	4.00	4.00	MHz
MMCM_T _{STATPHAOFFSET}	Static phase offset of the MMCM outputs ⁽²⁾	0.12	0.12	0.12	0.12	ns
MMCM_T _{OUTJITTER}	MMCM output jitter	Note 3				
MMCM_T _{OUTDUTY}	MMCM output clock duty cycle precision ⁽⁴⁾	0.165	0.20	0.20	0.20	ns
MMCM_T _{LOCKMAX}	MMCM maximum lock time for MMCM_F _{PFDMIN} frequencies above 20 MHz	100	100	100	100	μs
	MMCM maximum lock time for MMCM_F _{PFDMIN} frequencies from 10 MHz to 20 MHz	200	200	200	200	μs
MMCM_F _{OUTMAX}	MMCM maximum output frequency	850	725	630	630	MHz
MMCM_F _{OUTMIN}	MMCM minimum output frequency ⁽⁴⁾⁽⁵⁾	4.69	4.69	4.69	4.69	MHz
MMCM_T _{EXTFDVAR}	External clock feedback variation	< 20% of clock input period or 1 ns Max				
MMCM_RST _{MINPULSE}	Minimum reset pulse width	5.00	5.00	5.00	5.00	ns
MMCM_F _{PFDMAX}	Maximum frequency at the phase frequency detector	550	500	450	450	MHz
MMCM_F _{PFDMIN}	Minimum frequency at the phase frequency detector	10	10	10	10	MHz
MMCM_T _{FBDELAY}	Maximum delay in the feedback path	5 ns Max or one clock cycle				
MMCM_F _{DRPCLK_MAX}	Maximum DRP clock frequency	200	200	200	200	MHz

Notes:

1. The MMCM does not filter typical spread-spectrum input clocks because they are usually far below the bandwidth filter frequencies.
2. The static offset is measured between any MMCM outputs with identical phase.
3. Values for this parameter are available in the Clocking Wizard.
4. Includes global clock buffer.
5. Calculated as F_{VCO}/128 assuming output duty cycle is 50%.



PLL Switching Characteristics

Table 37: PLL Specification⁽¹⁾

Symbol	Description	Speed Grade and V _{CCINT} Operating Voltages				Units
		1.0V	0.95V		0.90V	
		-3	-2	-1/-1L	-1L	
PLL_F _{INMAX}	Maximum input clock frequency	1066	933	800	800	MHz
PLL_F _{INMIN}	Minimum input clock frequency	70	70	70	70	MHz
PLL_F _{INJITTER}	Maximum input clock period jitter	< 20% of clock input period or 1 ns Max				
PLL_F _{INDUTY}	Input duty cycle range: 70–399 MHz	35–65				%
	Input duty cycle range: 400–499 MHz	40–60				%
	Input duty cycle range: >500 MHz	45–55				%
PLL_F _{VCOMIN}	Minimum PLL VCO frequency	600	600	600	600	MHz
PLL_F _{VCOMAX}	Maximum PLL VCO frequency	1335	1335	1200	1200	MHz
PLL_T _{STATPHAOFFSET}	Static phase offset of the PLL outputs ⁽²⁾	0.12	0.12	0.12	0.12	ns
PLL_T _{OUTJITTER}	PLL output jitter	Note 3				
PLL_T _{OUTDUTY}	PLL CLKOUT0/CLKOUT0B/CLKOUT1/CLKOUT1B duty-cycle precision ⁽⁴⁾	0.165	0.20	0.20	0.20	ns
PLL_T _{LOCKMAX}	PLL maximum lock time	100				µs
PLL_F _{OUTMAX}	PLL maximum output frequency at CLKOUT0/CLKOUT0B/CLKOUT1/CLKOUT1B	850	725	630	630	MHz
	PLL maximum output frequency at CLKOUTPHY	2670	2670	2400	2400	MHz
PLL_F _{OUTMIN}	PLL minimum output frequency at CLKOUT0/CLKOUT0B/CLKOUT1/CLKOUT1B ⁽⁵⁾	4.69	4.69	4.69	4.69	MHz
	PLL minimum output frequency at CLKOUTPHY	2 x VCO mode: 1200 1 x VCO mode: 600 0.5 x VCO mode: 300				MHz
PLL_RST _{MINPULSE}	Minimum reset pulse width	5.00	5.00	5.00	5.00	ns
PLL_F _{PFDMAX}	Maximum frequency at the phase frequency detector	667.5	667.5	600	600	MHz
PLL_F _{PFDMIN}	Minimum frequency at the phase frequency detector	70	70	70	70	MHz
PLL_F _{BANDWIDTH}	PLL bandwidth at typical	15	15	15	15	MHz
PLL_F _{DRPCLK_MAX}	Maximum DRP clock frequency	200	200	200	200	MHz

Notes:

1. The PLL does not filter typical spread-spectrum input clocks because they are usually far below the loop filter frequencies.
2. The static offset is measured between any PLL outputs with identical phase.
3. Values for this parameter are available in the Clocking Wizard.
4. Includes global clock buffer.
5. Calculated as $F_{VCO}/128$ assuming output duty cycle is 50%.



Device Pin-to-Pin Output Parameter Guidelines

The pin-to-pin numbers in [Table 38](#) through [Table 41](#) are based on the clock root placement in the center of the device. The actual pin-to-pin values will vary if the root placement selected is different. Consult the Vivado Design Suite timing report for the actual pin-to-pin values.

Table 38: Global Clock Input to Output Delay Without MMCM/PLL (Near Clock Region)

Symbol	Description	Device	Speed Grade and V _{CCINT} Operating Voltages					Units
			1.0V	0.95V			0.90V	
			-3	-2	-1	-1L	-1L	
SSTL15 Global Clock Input to Output Delay using Output Flip-Flop, Fast Slew Rate, <i>without</i> MMCM/PLL.								
T _{ICKOF}	Global clock input and output flip-flop <i>without</i> MMCM/PLL (near clock region)	XCKU025	N/A	6.07	7.00	N/A	N/A	ns
		XCKU035	5.40	6.21	7.05	7.05	7.44	ns
		XCKU040	5.40	6.21	7.05	7.05	7.44	ns
		XCKU060	5.19	5.99	6.93	6.93	7.19	ns
		XCKU085	5.20	6.08	7.08	7.08	7.19	ns
		XCKU095	N/A	6.09	7.13	N/A	N/A	ns
		XCKU115	5.20	6.08	7.08	7.08	7.19	ns
		XQKU040	N/A	6.21	7.17	N/A	N/A	ns
		XQKU060	N/A	5.99	6.93	N/A	N/A	ns
		XQKU095	N/A	6.09	7.13	N/A	N/A	ns
		XQKU115	N/A	6.08	7.08	N/A	N/A	ns

Notes:

1. This table lists representative values where one global clock input drives one vertical clock line in each accessible column, and where all accessible I/O and CLB flip-flops are clocked by the global clock net in a single SLR.



Table 39: Global Clock Input to Output Delay Without MMCM/PLL (Far Clock Region)

Symbol	Description	Device	Speed Grade and V _{CCINT} Operating Voltages					Units
			1.0V	0.95V			0.90V	
			-3	-2	-1	-1L	-1L	
SSTL15 Global Clock Input to Output Delay using Output Flip-Flop, Fast Slew Rate, <i>without</i> MMCM/PLL.								
T _{ICKOF_FAR}	Global clock input and output flip-flop <i>without</i> MMCM/PLL (far clock region)	XCKU025	N/A	6.40	7.37	N/A	N/A	ns
		XCKU035	5.84	6.73	7.64	7.64	8.09	ns
		XCKU040	5.84	6.73	7.64	7.64	8.09	ns
		XCKU060	5.94	6.84	7.91	7.91	8.22	ns
		XCKU085	5.95	6.98	8.12	8.12	8.21	ns
		XCKU095	N/A	6.67	7.69	N/A	N/A	ns
		XCKU115	5.95	6.98	8.12	8.12	8.21	ns
		XQKU040	N/A	6.73	7.75	N/A	N/A	ns
		XQKU060	N/A	6.84	7.91	N/A	N/A	ns
		XQKU095	N/A	6.67	7.69	N/A	N/A	ns
		XQKU115	N/A	6.98	8.12	N/A	N/A	ns

Notes:

1. This table lists representative values where one global clock input drives one vertical clock line in each accessible column, and where all accessible I/O and CLB flip-flops are clocked by the global clock net in a single SLR.

Table 40: Global Clock Input to Output Delay With MMCM

Symbol	Description	Device	Speed Grade and V _{CCINT} Operating Voltages					Units
			1.0V	0.95V			0.90V	
			-3	-2	-1	-1L	-1L	
SSTL15 Global Clock Input to Output Delay using Output Flip-Flop, Fast Slew Rate, <i>with</i> MMCM.								
T _{ICKOFMMCMCC}	Global clock input and output flip-flop <i>with</i> MMCM	XCKU025	N/A	1.80	1.88	N/A	N/A	ns
		XCKU035	2.13	2.45	2.78	2.78	3.72	ns
		XCKU040	2.13	2.45	2.78	2.78	3.72	ns
		XCKU060	1.58	1.92	2.05	2.05	2.41	ns
		XCKU085	1.58	1.95	2.12	2.12	2.41	ns
		XCKU095	N/A	1.59	1.85	N/A	N/A	ns
		XCKU115	1.58	1.95	2.12	2.12	2.41	ns
		XQKU040	N/A	1.81	1.91	N/A	N/A	ns
		XQKU060	N/A	1.92	2.05	N/A	N/A	ns
		XQKU095	N/A	1.59	1.85	N/A	N/A	ns
		XQKU115	N/A	1.95	2.12	N/A	N/A	ns

Notes:

1. This table lists representative values where one global clock input drives one vertical clock line in each accessible column, and where all accessible I/O and CLB flip-flops are clocked by the global clock net in a single SLR.
2. MMCM output jitter is already included in the timing calculation.



Table 41: Global Clock Input to Output Delay With PLL

Symbol	Description	Device	Speed Grade and V _{CCINT} Operating Voltages					Units
			1.0V	0.95V			0.90V	
			-3	-2	-1	-1L	-1L	
SSTL15 Global Clock Input to Output Delay using Output Flip-Flop, Fast Slew Rate, with PLL.								
T _{ICKOF_PLL_CC}	Global clock input and output flip-flop <i>with</i> PLL	XCKU025	N/A	5.39	6.11	N/A	N/A	ns
		XCKU035	4.25	4.46	5.08	5.08	5.46	ns
		XCKU040	4.25	4.46	5.08	5.08	5.46	ns
		XCKU060	5.13	5.83	6.66	6.66	6.95	ns
		XCKU085	5.14	5.96	6.85	6.85	6.96	ns
		XCKU095	N/A	5.70	6.49	N/A	N/A	ns
		XCKU115	5.14	5.96	6.85	6.85	6.96	ns
		XQKU040	N/A	5.72	6.50	N/A	N/A	ns
		XQKU060	N/A	5.83	6.66	N/A	N/A	ns
		XQKU095	N/A	5.70	6.49	N/A	N/A	ns
		XQKU115	N/A	5.96	6.85	N/A	N/A	ns

Notes:

1. This table lists representative values where one global clock input drives one vertical clock line in each accessible column, and where all accessible I/O and CLB flip-flops are clocked by the global clock net in a single SLR.
2. PLL output jitter is already included in the timing calculation.

Table 42: Source Synchronous Output Characteristics (Component Mode)

Symbol	Description	Speed Grade and V _{CCINT} Operating Voltages					Units
		1.0V	0.95V			0.90V	
		-3	-2	-1	-1L	-1L	
T _{OUTPUT_LOGIC_DELAY_VARIATION}	Delay mismatch across a transmit bus when using component mode output logic (ODDRE1, OSERDESE3) within a bank	100					ps



Device Pin-to-Pin Input Parameter Guidelines

The pin-to-pin numbers in [Table 43](#) through [Table 44](#) are based on the clock root placement in the center of the device. The actual pin-to-pin values will vary if the root placement selected is different. Consult the Vivado Design Suite timing report for the actual pin-to-pin values.

Table 43: Global Clock Input Setup and Hold With MMCM

Symbol	Description	Device	Speed Grade, V _{CCINT} Operating Voltage, and Temperature Range						Units	
			1.0V	0.95V			0.90V			
			-3E	-2E/I	-1C/I	-1M	-1LI	-1LI		
Input Setup and Hold Time Relative to Global Clock Input Signal using SSTL15 Standard. ⁽¹⁾⁽²⁾⁽³⁾										
T _{PSMMCMCC_KU025}	Global clock input and input flip-flop (or latch) with MMCM	Setup	XCKU025	N/A	2.16	2.51	N/A	N/A	N/A	ns
T _{PHMMCMCC_KU025}		Hold		N/A	-0.48	-0.48	N/A	N/A	N/A	ns
T _{PSMMCMCC_KU035}		Setup	XCKU035	1.70	1.72	1.74	N/A	1.74	2.07	ns
T _{PHMMCMCC_KU035}		Hold		-0.23	-0.23	-0.23	N/A	-0.23	-0.13	ns
T _{PSMMCMCC_KU040}		Setup	XCKU040	1.70	1.72	1.74	N/A	1.74	2.07	ns
T _{PHMMCMCC_KU040}		Hold		-0.23	-0.23	-0.23	N/A	-0.23	-0.13	ns
T _{PSMMCMCC_KU060}		Setup	XCKU060	2.21	2.23	2.51	N/A	2.51	2.55	ns
T _{PHMMCMCC_KU060}		Hold		-0.47	-0.47	-0.47	N/A	-0.47	-0.15	ns
T _{PSMMCMCC_KU085}		Setup	XCKU085	2.21	2.23	2.51	N/A	2.51	2.55	ns
T _{PHMMCMCC_KU085}		Hold		-0.37	-0.37	-0.37	N/A	-0.37	-0.15	ns
T _{PSMMCMCC_KU095}		Setup	XCKU095	N/A	2.25	2.55	N/A	N/A	N/A	ns
T _{PHMMCMCC_KU095}		Hold		N/A	-0.47	-0.47	N/A	N/A	N/A	ns
T _{PSMMCMCC_KU115}		Setup	XCKU115	2.21	2.23	2.51	N/A	2.51	2.55	ns
T _{PHMMCMCC_KU115}		Hold		-0.37	-0.37	-0.37	N/A	-0.37	-0.15	ns
T _{PSMMCMCC_KU040}		Setup	XQKU040	N/A	2.23	2.58	2.60	N/A	N/A	ns
T _{PHMMCMCC_KU040}		Hold		N/A	-0.45	-0.45	-0.45	N/A	N/A	ns
T _{PSMMCMCC_KU060}		Setup	XQKU060	N/A	2.23	2.51	2.52	N/A	N/A	ns
T _{PHMMCMCC_KU060}		Hold		N/A	-0.47	-0.47	-0.47	N/A	N/A	ns
T _{PSMMCMCC_KU095}		Setup	XQKU095	N/A	2.25	2.55	2.56	N/A	N/A	ns
T _{PHMMCMCC_KU095}		Hold		N/A	-0.47	-0.47	-0.47	N/A	N/A	ns
T _{PSMMCMCC_KU115}		Setup	XQKU115	N/A	2.23	2.51	N/A	N/A	N/A	ns
T _{PHMMCMCC_KU115}		Hold		N/A	-0.37	-0.37	N/A	N/A	N/A	ns

Notes:

- Setup and hold times are measured over worst case conditions (process, voltage, temperature). Setup time is measured relative to the global clock input signal using the slowest process, slowest temperature, and slowest voltage. Hold time is measured relative to the global clock input signal using the fastest process, fastest temperature, and fastest voltage.
- This table lists representative values where one global clock input drives one vertical clock line in each accessible column, and where all accessible I/O and CLB flip-flops are clocked by the global clock net in a single SLR.
- Use IBIS to determine any duty-cycle distortion incurred using various standards.



Table 44: Global Clock Input Setup and Hold With PLL

Symbol	Description	Device	Speed Grade, V _{CCINT} Operating Voltage, and Temperature Range						Units	
			1.0V	0.95V			0.90V			
			-3	-2	-1	-1M	-1L	-1L		
Input Setup and Hold Time Relative to Global Clock Input Signal using SSTL15 Standard. (1)(2)(3)										
T _{PSPLLCC_KU025}	Global clock input and input flip-flop (or latch) with PLL	Setup	XCKU025	N/A	-0.48	-0.48	N/A	N/A	N/A	ns
T _{PHPLLCC_KU025}		Hold		N/A	2.42	2.70	N/A	N/A	N/A	ns
T _{PSPLLCC_KU035}		Setup	XCKU035	0.00	0.00	0.00	N/A	0.00	0.00	ns
T _{PHPLLCC_KU035}		Hold		1.36	1.59	1.79	N/A	1.79	1.79	ns
T _{PSPLLCC_KU040}		Setup	XCKU040	0.00	0.00	0.00	N/A	0.00	0.00	ns
T _{PHPLLCC_KU040}		Hold		1.36	1.59	1.79	N/A	1.79	1.79	ns
T _{PSPLLCC_KU060}		Setup	XCKU060	-0.70	-0.70	-0.70	N/A	-0.70	-0.78	ns
T _{PHPLLCC_KU060}		Hold		2.18	2.41	2.75	N/A	2.75	2.98	ns
T _{PSPLLCC_KU085}		Setup	XCKU085	-0.66	-0.66	-0.66	N/A	-0.66	-0.78	ns
T _{PHPLLCC_KU085}		Hold		2.18	2.46	2.83	N/A	2.83	2.98	ns
T _{PSPLLCC_KU095}		Setup	XCKU095	N/A	-0.94	-0.94	N/A	N/A	N/A	ns
T _{PHPLLCC_KU095}		Hold		N/A	2.36	2.71	N/A	N/A	N/A	ns
T _{PSPLLCC_KU115}		Setup	XCKU115	-0.66	-0.66	-0.66	N/A	-0.66	-0.78	ns
T _{PHPLLCC_KU115}		Hold		2.18	2.46	2.83	N/A	2.83	2.98	ns
T _{PSPLLCC_KU040}		Setup	XQKU040	N/A	-0.67	-0.67	-0.67	N/A	N/A	ns
T _{PHPLLCC_KU040}		Hold		N/A	2.48	2.83	2.84	N/A	N/A	ns
T _{PSPLLCC_KU060}		Setup	XQKU060	N/A	-0.70	-0.70	-0.70	N/A	N/A	ns
T _{PHPLLCC_KU060}		Hold		N/A	2.41	2.75	2.75	N/A	N/A	ns
T _{PSPLLCC_KU095}		Setup	XQKU095	N/A	-0.94	-0.94	-0.94	N/A	N/A	ns
T _{PHPLLCC_KU095}		Hold		N/A	2.36	2.71	2.71	N/A	N/A	ns
T _{PSPLLCC_KU115}		Setup	XQKU115	N/A	-0.66	-0.66	N/A	N/A	N/A	ns
T _{PHPLLCC_KU115}		Hold		N/A	2.46	2.83	N/A	N/A	N/A	ns

Notes:

1. Setup and hold times are measured over worst case conditions (process, voltage, temperature). Setup time is measured relative to the global clock input signal using the slowest process, slowest temperature, and slowest voltage. Hold time is measured relative to the global clock input signal using the fastest process, fastest temperature, and fastest voltage.
2. This table lists representative values where one global clock input drives one vertical clock line in each accessible column, and where all accessible I/O and CLB flip-flops are clocked by the global clock net in a single SLR.
3. Use IBIS to determine any duty-cycle distortion incurred using various standards.



Table 45: Sampling Window

Symbol	Description	Speed Grade and V _{CCINT} Operating Voltages						Units
		1.0V	0.95V				0.90V	
		-3	-2E	-2I	-1	-1L	-1L	
T _{SAMP_BUF} ⁽¹⁾	Total sampling error of the Kintex UltraScale FPGAs DDR input registers, measured across voltage, temperature, and process	510	560	610	610	610	610	ps
T _{SAMP_NATIVE_DPA}	Receive sampling error for RX_BITSLICE when using dynamic phase alignment	100	100	100	125	125	150	ps
T _{SAMP_NATIVE_BISC}	Receive sampling error for RX_BITSLICE when using built-in self-calibration (BISC)	60	60	60	85	85	110	ps

Notes:

- The characterization methodology uses the MMCM to capture the DDR input registers' edges of operation. These measurements include: CLK0 MMCM jitter, MMCM accuracy (phase offset), and MMCM phase shift resolution. These measurements do not include package or clock tree skew. For detailed component mode sampling window calculations using the parameters in this table, see the *Designing Using SelectIO Interface Component Primitives* ([XAPP1324](#)) application note.

Table 46: Input Logic Characteristics for Dynamic Phase Aligned Applications (Component Mode)

Symbol	Description	Speed Grade and V _{CCINT} Operating Voltages						Units
		1.0V	0.95V				0.90V	
		-3	-2E	-2I	-1	-1L	-1L	
T _{INPUT_LOGIC_UNCERTAINTY}	Accounts for the setup/hold and any pattern dependent jitter for the input logic (input register, IDDRE1, or ISERDESE3)	40						ps
T _{CAL_ERROR}	Calibration error associated with quantization effects based on the IDELAY resolution. Calibration must be performed for each input pin to ensure optimal performance	24						ps



Package Parameter Guidelines

The parameters in this section provide the necessary values for calculating timing budgets for clock transmitter and receiver data-valid windows.

Table 47: Package Skew

Symbol	Description	Device	Package	Value	Units		
PKGSKEW	Package Skew	XCKU025	FFVA1156	162	ps		
		XCKU035	FBVA676	173	ps		
			SFVA784	134	ps		
			FBVA900	184	ps		
			FFVA1156	168	ps		
		XCKU040	FBVA676	173	ps		
			SFVA784	134	ps		
			FBVA900	184	ps		
			FFVA1156	168	ps		
		XCKU060	FFVA1156	168	ps		
			FFVA1517	169	ps		
		XCKU085	FLVA1517	217	ps		
			FLVB1760	175	ps		
			FLVF1924	143	ps		
		XCKU095	FFVA1156	162	ps		
			FFVC1517	181	ps		
			FFVB1760	128	ps		
			FFVB2104	191	ps		
		PKGSKEW (cont'd)	Package Skew	XCKU115	FLVA1517	217	ps
					FLVD1517	143	ps
FLVB1760	177				ps		
FLVD1924	172				ps		
FLVF1924	143				ps		
FLVA2104	184				ps		
FLVB2104	198				ps		
XQKU040	RBA676			178	ps		
	RFA1156			164	ps		
XQKU060	RFA1156			170	ps		
XQKU095	RFA1156			163	ps		
XQKU115	RLD1517			147	ps		
	RLF1924			146	ps		

Notes:

1. These values represent the worst-case skew between any two SelectIO resources in the package: shortest delay to longest delay from die pad to ball.
2. Package delay information is available for these device/package combinations. This information can be used to deskew the package.



GTH Transceiver Specifications

GTH Transceiver DC Input and Output Levels

Table 48 summarizes the DC specifications of the GTH transceivers in Kintex UltraScale FPGAs. Consult the *UltraScale Architecture GTH Transceiver User Guide* ([UG576](#)) for further details.

Table 48: GTH Transceiver DC Specifications

Symbol	DC Parameter	Conditions	Min	Typ	Max	Units
D _{VPPIN}	Differential peak-to-peak input voltage (external AC coupled)	> 10.3125 Gb/s	150	–	1250	mV
		6.6 Gb/s to 10.3125 Gb/s	150	–	1250	mV
		≤ 6.6 Gb/s	150	–	2000	mV
V _{IN}	Single-ended input voltage. Voltage measured at the pin referenced to GND.	DC coupled V _{MGTAVTT} = 1.2V	–400	–	V _{MGTAVTT}	mV
V _{CMIN}	Common mode input voltage	DC coupled V _{MGTAVTT} = 1.2V	–	2/3 V _{MGTAVTT}	–	mV
D _{VPPOUT}	Differential peak-to-peak output voltage ⁽¹⁾	Transmitter output swing is set to 1100	800	–	–	mV
V _{CMOUTDC}	Common mode output voltage: DC coupled (equation based)	When remote RX is terminated to GND	$V_{MGTAVTT}/2 - D_{VPPOUT}/4$			mV
		When remote RX termination is floating	$V_{MGTAVTT} - D_{VPPOUT}/2$			mV
		When remote RX is terminated to V _{RX_TERM} ⁽²⁾	$V_{MGTAVTT} - \frac{D_{VPPOUT}}{4} - \left(\frac{V_{MGTAVTT} - V_{RX_TERM}}{2}\right)$			mV
V _{CMOUTAC}	Common mode output voltage: AC coupled (equation based)		$V_{MGTAVTT} - D_{VPPOUT}/2$			mV
R _{IN}	Differential input resistance		–	100	–	Ω
R _{OUT}	Differential output resistance		–	100	–	Ω
T _{OSKEW}	Transmitter output pair (TXP and TXN) intra-pair skew (All packages)		–	–	10	ps
C _{EXT}	Recommended external AC coupling capacitor ⁽³⁾		–	100	–	nF

Notes:

- The output swing and pre-emphasis levels are programmable using the attributes discussed in the *UltraScale Architecture GTH Transceiver User Guide* ([UG576](#)), and can result in values lower than reported in this table.
- V_{RX_TERM} is the remote RX termination voltage.
- Other values can be used as appropriate to conform to specific protocols and standards.

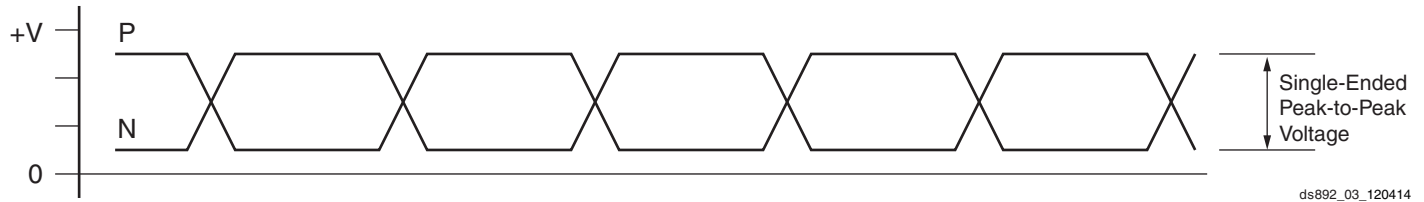

Figure 3: Single-Ended Peak-to-Peak Voltage

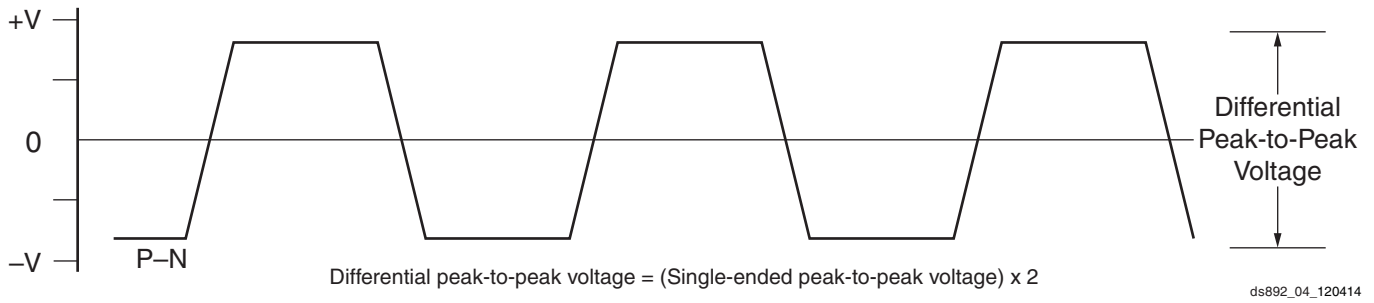

Figure 4: Differential Peak-to-Peak Voltage

Table 49 and Table 50 summarize the DC specifications of the GTH transceivers input and output clocks in Kintex UltraScale FPGAs. Consult the *UltraScale Architecture GTH Transceiver User Guide* ([UG576](#)) for further details.

Table 49: GTH Transceiver Clock DC Input Level Specification

Symbol	DC Parameter	Min	Typ	Max	Units
V_{IDIFF}	Differential peak-to-peak input voltage	250	–	2000	mV
R_{IN}	Differential input resistance	–	100	–	Ω
C_{EXT}	Required external AC coupling capacitor	–	10	–	nF

Table 50: GTH Transceiver Clock Output Level Specification

Symbol	Description	Conditions	Min	Typ	Max	Units
V_{OL}	Output low voltage for P and N	$R_T = 100\Omega$ across P and N signals	–	400	–	mV
V_{OH}	Output high voltage for P and N	$R_T = 100\Omega$ across P and N signals	–	760	–	mV
V_{DDOUT}	Differential output voltage (P–N), P = High (N–P), N = High	$R_T = 100\Omega$ across P and N signals	–	± 360	–	mV
V_{CMOUT}	Common mode voltage	$R_T = 100\Omega$ across P and N signals	–	580	–	mV



GTH Transceiver Switching Characteristics

Consult the *UltraScale Architecture GTH Transceiver User Guide* ([UG576](#)) for further information.

Table 51: GTH Transceiver Performance

Symbol	Description	Output Divider	Speed Grade, Temperature Ranges, and V _{CCINT} Operating Voltages								Units
			1.0V		0.95V				0.90V		
			-3E		-2E, -2I		-1C, -1I, -1M, -1LI		-1LI		
Package Type		FF/FL	FB/SF	FF/FL RF/RL	FB/SF RB	All Packages		All Packages			
F _{GTHMAX}	GTH maximum line rate		16.375	12.5	16.375	12.5	12.5		12.5 ⁽¹⁾		Gb/s
F _{GTHMIN}	GTH minimum line rate		0.5	0.5	0.5	0.5	0.5		0.5		Gb/s
			Min	Max	Min	Max	Min	Max	Min	Max	
F _{GTHCRANGE}	CPLL line rate range ⁽²⁾	1	4.0	12.5	4.0	12.5	4.0	8.5	4.0	8.5	Gb/s
		2	2.0	6.25	2.0	6.25	2.0	4.25	2.0	4.25	Gb/s
		4	1.0	3.125	1.0	3.125	1.0	2.125	1.0	2.125	Gb/s
		8	0.5	1.5625	0.5	1.5625	0.5	1.0625	0.5	1.0625	Gb/s
		16	N/A								Gb/s
			Min	Max	Min	Max	Min	Max	Min	Max	
F _{GTHORANGE1}	QPLL0 line rate range ⁽³⁾	1	9.8	16.375	9.8	16.375	9.8	12.5	9.8	12.5	Gb/s
		2	4.9	8.1875	4.9	8.1875	4.9	8.1875	4.9	8.1875	Gb/s
		4	2.45	4.0938	2.45	4.0938	2.45	4.0938	2.45	4.0938	Gb/s
		8	1.225	2.0469	1.225	2.0469	1.225	2.0469	1.225	2.0469	Gb/s
		16	0.6125	1.0234	0.6125	1.0234	0.6125	1.0234	0.6125	1.0234	Gb/s
			Min	Max	Min	Max	Min	Max	Min	Max	
F _{GTHORANGE2}	QPLL1 line rate range ⁽⁴⁾	1	8.0	13.0	8.0	13.0	8.0	12.5	8.0	12.5	Gb/s
		2	4.0	6.5	4.0	6.5	4.0	6.5	4.0	6.5	Gb/s
		4	2.0	3.25	2.0	3.25	2.0	3.25	2.0	3.25	Gb/s
		8	1.0	1.625	1.0	1.625	1.0	1.625	1.0	1.625	Gb/s
		16	0.5	0.8125	0.5	0.8125	0.5	0.8125	0.5	0.8125	Gb/s
			Min	Max	Min	Max	Min	Max	Min	Max	
F _{CPLL} RANGE	CPLL frequency range		2.0	6.25	2.0	6.25	2.0	4.25	2.0	4.25	GHz
F _{QPLL0} RANGE	QPLL0 frequency range		9.8	16.375	9.8	16.375	9.8	16.375	9.8	16.375	GHz
F _{QPLL1} RANGE	QPLL1 frequency range		8.0	13.0	8.0	13.0	8.0	13.0	8.0	13.0	GHz

Notes:

1. Designs must use Vivado Design Suite v2015.4.1 or later to achieve 12.5 Gb/s.
2. The values listed are the rounded results of the calculated equation $(2 \times \text{CPLL_Frequency}) / \text{Output_Divider}$.
3. The values listed are the rounded results of the calculated equation $(\text{QPLL0_Frequency}) / \text{Output_Divider}$.
4. The values listed are the rounded results of the calculated equation $(\text{QPLL1_Frequency}) / \text{Output_Divider}$.

Table 52: GTH Transceiver Dynamic Reconfiguration Port (DRP) Switching Characteristics

Symbol	Description	All Devices	Units
F _{GTHDRPCLK}	GTHDRPCLK maximum frequency	250	MHz



Table 53: GTH Transceiver Reference Clock Switching Characteristics

Symbol	Description	Conditions	Min	Typ	Max	Units
F_{GCLK}	Reference clock frequency range		60	–	820	MHz
T_{RCLK}	Reference clock rise time	20% – 80%	–	200	–	ps
T_{FCLK}	Reference clock fall time	80% – 20%	–	200	–	ps
T_{DCREF}	Reference clock duty cycle	Transceiver PLL only	40	50	60	%

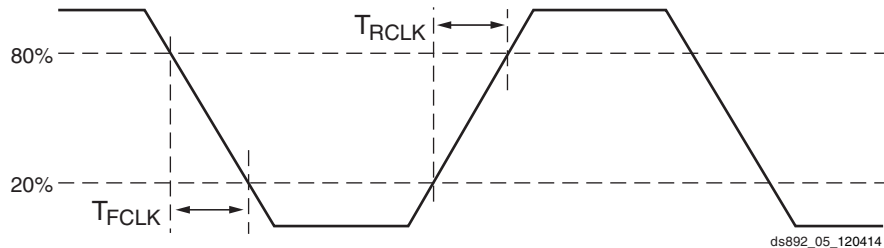

Figure 5: Reference Clock Timing Parameters

Table 54: GTH Transceiver Reference Clock Oscillator Selection Phase Noise Mask

Symbol	Description	Offset Frequency	Min	Typ	Max	Units
$QPLL_{REFCLKMASK}^{(1)(2)}$	QPLL0/QPLL1 reference clock select phase noise mask at REFCLK frequency = 312.5 MHz.	10 kHz	–	–	–105	dBc/Hz
		100 kHz	–	–	–124	
		1 MHz	–	–	–130	
$CPLL_{REFCLKMASK}^{(1)(2)}$	CPLL reference clock select phase noise mask at REFCLK frequency = 312.5 MHz.	10 kHz	–	–	–105	dBc/Hz
		100 kHz	–	–	–124	
		1 MHz	–	–	–130	
		50 MHz	–	–	–140	

Notes:

- For reference clock frequencies other than 312.5 MHz, adjust the phase-noise mask values by $20 \times \log(N/312.5)$ where N is the new reference clock frequency in MHz.
- This reference clock phase-noise mask is superseded by any reference clock phase-noise mask that is specified in a supported protocol, e.g., PCIe.

Table 55: GTH Transceiver PLL/Lock Time Adaptation

Symbol	Description	Conditions	Min	Typ	Max	Units
T_{LOCK}	Initial PLL lock		–	–	1	ms
T_{DLOCK}	Clock recovery phase acquisition and adaptation time for decision feedback equalizer (DFE)	After the PLL is locked to the reference clock, this is the time it takes to lock the clock data recovery (CDR) to the data present at the input	–	50,000	37×10^6	UI
	Clock recovery phase acquisition and adaptation time for low-power mode (LPM) when the DFE is disabled		–	50,000	2.3×10^6	UI

Table 56: GTH Transceiver User Clock Switching Characteristics⁽¹⁾

Symbol	Description	Data Width Conditions (Bit)		Speed Grade, Temperature Ranges, and V _{CCINT} Operating Voltages				Units
				1.0V	0.95V		0.90V	
		Internal Logic	Interconnect Logic	-3E	-2E, -2I	-1C, -1I, -1M, -1LI	-1LI	
F _{TXOUTPMA}	TXOUTCLK maximum frequency sourced from OUTCLKPMA			511.719	511.719	390.625	390.625	MHz
F _{RXOUTPMA}	RXOUTCLK maximum frequency sourced from OUTCLKPMA			511.719	511.719	390.625	390.625	MHz
F _{TXOUTPROGDIV}	TXOUTCLK maximum frequency sourced from TXPROGDIVCLK			511.719	511.719	511.719	511.719	MHz
F _{RXOUTPROGDIV}	RXOUTCLK maximum frequency sourced from RXPROGDIVCLK			511.719	511.719	511.719	511.719	MHz
F _{TXIN}	TXUSRCLK maximum frequency	16	16, 32	511.719	511.719	390.625	390.625	MHz
		32	32, 64	511.719	511.719	390.625	390.625	MHz
		20	20, 40	409.375	409.375	312.500	312.500	MHz
		40	40, 80	409.375	409.375	312.500	312.500	MHz
F _{RXIN}	RXUSRCLK maximum frequency	16	16, 32	511.719	511.719	390.625	390.625	MHz
		32	32, 64	511.719	511.719	390.625	390.625	MHz
		20	20, 40	409.375	409.375	312.500	312.500	MHz
		40	40, 80	409.375	409.375	312.500	312.500	MHz
F _{TXIN2}	TXUSRCLK2 maximum frequency	16	16	511.719	511.719	390.625	390.625	MHz
		16, 32	32	511.719	511.719	390.625	390.625	MHz
		32	64	255.860	255.860	195.313	195.313	MHz
		20	20	409.375	409.375	312.500	312.500	MHz
		20, 40	40	409.375	409.375	312.500	312.500	MHz
		40	80	204.688	204.688	156.250	156.250	MHz
F _{RXIN2}	RXUSRCLK2 maximum frequency	16	16	511.719	511.719	390.625	390.625	MHz
		16, 32	32	511.719	511.719	390.625	390.625	MHz
		32	64	255.860	255.860	195.313	195.313	MHz
		20	20	409.375	409.375	312.500	312.500	MHz
		20, 40	40	409.375	409.375	312.500	312.500	MHz
		40	80	204.688	204.688	156.250	156.250	MHz

Notes:

1. Clocking must be implemented as described in *UltraScale Architecture GTH Transceiver User Guide* ([UG576](#)).



Table 57: GTH Transceiver Transmitter Switching Characteristics

Symbol	Description	Condition	Min	Typ	Max	Units
F_{GTHTX}	Serial data rate range		0.500	–	F_{GTHMAX}	Gb/s
T_{RTX}	TX rise time	20%–80%	–	21	–	ps
T_{FTX}	TX fall time	80%–20%	–	21	–	ps
T_{LLSKEW}	TX lane-to-lane skew ⁽¹⁾		–	–	500	ps
$V_{TXOOBVDPP}$	Electrical idle amplitude		–	–	15	mV
$T_{TXOOBTRANSITION}$	Electrical idle transition time		–	–	140	ns
$T_{J16.3_QPLL}$	Total jitter ⁽²⁾⁽⁴⁾	16.3 Gb/s	–	–	0.28	UI
$D_{J16.3_QPLL}$	Deterministic jitter ⁽²⁾⁽⁴⁾		–	–	0.17	UI
T_{J15_QPLL}	Total jitter ⁽²⁾⁽⁴⁾	15.0 Gb/s	–	–	0.28	UI
D_{J15_QPLL}	Deterministic jitter ⁽²⁾⁽⁴⁾		–	–	0.17	UI
$T_{J14.1_QPLL}$	Total jitter ⁽²⁾⁽⁴⁾	14.1 Gb/s	–	–	0.28	UI
$D_{J14.1_QPLL}$	Deterministic jitter ⁽²⁾⁽⁴⁾		–	–	0.17	UI
$T_{J14.025_QPLL}$	Total jitter ⁽²⁾⁽⁴⁾	14.025 Gb/s	–	–	0.28	UI
$D_{J14.025_QPLL}$	Deterministic jitter ⁽²⁾⁽⁴⁾		–	–	0.17	UI
$T_{J13.1_QPLL}$	Total jitter ⁽²⁾⁽⁴⁾	13.1 Gb/s	–	–	0.28	UI
$D_{J13.1_QPLL}$	Deterministic jitter ⁽²⁾⁽⁴⁾		–	–	0.17	UI
$T_{J12.5_QPLL}$	Total jitter ⁽²⁾⁽⁴⁾	12.5 Gb/s	–	–	0.28	UI
$D_{J12.5_QPLL}$	Deterministic jitter ⁽²⁾⁽⁴⁾		–	–	0.17	UI
$T_{J12.5_CPLL}$	Total jitter ⁽³⁾⁽⁴⁾	12.5 Gb/s	–	–	0.33	UI
$D_{J12.5_CPLL}$	Deterministic jitter ⁽³⁾⁽⁴⁾		–	–	0.17	UI
$T_{J11.3_QPLL}$	Total jitter ⁽²⁾⁽⁴⁾	11.3 Gb/s	–	–	0.28	UI
$D_{J11.3_QPLL}$	Deterministic jitter ⁽²⁾⁽⁴⁾		–	–	0.17	UI
$T_{J10.3_QPLL}$	Total jitter ⁽²⁾⁽⁴⁾	10.3 Gb/s	–	–	0.28	UI
$D_{J10.3_QPLL}$	Deterministic jitter ⁽²⁾⁽⁴⁾		–	–	0.17	UI
$T_{J10.3_CPLL}$	Total jitter ⁽³⁾⁽⁴⁾	10.3 Gb/s	–	–	0.33	UI
$D_{J10.3_CPLL}$	Deterministic jitter ⁽³⁾⁽⁴⁾		–	–	0.17	UI
$T_{J9.8_QPLL}$	Total jitter ⁽²⁾⁽⁴⁾	9.8 Gb/s	–	–	0.28	UI
$D_{J9.8_QPLL}$	Deterministic jitter ⁽²⁾⁽⁴⁾		–	–	0.17	UI
$T_{J9.8_CPLL}$	Total jitter ⁽³⁾⁽⁴⁾	9.8 Gb/s	–	–	0.28	UI
$D_{J9.8_CPLL}$	Deterministic jitter ⁽³⁾⁽⁴⁾		–	–	0.17	UI
$T_{J8.0_CPLL}$	Total jitter ⁽³⁾⁽⁴⁾	8.0 Gb/s	–	–	0.32	UI
$D_{J8.0_CPLL}$	Deterministic jitter ⁽³⁾⁽⁴⁾		–	–	0.17	UI
$T_{J6.6_CPLL}$	Total jitter ⁽³⁾⁽⁴⁾	6.6 Gb/s	–	–	0.30	UI
$D_{J6.6_CPLL}$	Deterministic jitter ⁽³⁾⁽⁴⁾		–	–	0.15	UI
$T_{J5.0}$	Total jitter ⁽³⁾⁽⁴⁾	5.0 Gb/s	–	–	0.30	UI
$D_{J5.0}$	Deterministic jitter ⁽³⁾⁽⁴⁾		–	–	0.15	UI
$T_{J4.25}$	Total jitter ⁽³⁾⁽⁴⁾	4.25 Gb/s	–	–	0.30	UI
$D_{J4.25}$	Deterministic jitter ⁽³⁾⁽⁴⁾		–	–	0.15	UI
$T_{J4.0L}$	Total jitter ⁽³⁾⁽⁴⁾	4.0 Gb/s ⁽⁵⁾	–	–	0.32	UI
$D_{J4.0L}$	Deterministic jitter ⁽³⁾⁽⁴⁾		–	–	0.16	UI



Table 57: GTH Transceiver Transmitter Switching Characteristics (Cont'd)

Symbol	Description	Condition	Min	Typ	Max	Units
T _{J3.2}	Total jitter ⁽³⁾⁽⁴⁾	3.2 Gb/s ⁽⁶⁾	–	–	0.20	UI
D _{J3.2}	Deterministic jitter ⁽³⁾⁽⁴⁾		–	–	0.10	UI
T _{J2.5}	Total jitter ⁽³⁾⁽⁴⁾	2.5 Gb/s ⁽⁷⁾	–	–	0.20	UI
D _{J2.5}	Deterministic jitter ⁽³⁾⁽⁴⁾		–	–	0.10	UI
T _{J1.25}	Total jitter ⁽³⁾⁽⁴⁾	1.25 Gb/s ⁽⁸⁾	–	–	0.15	UI
D _{J1.25}	Deterministic jitter ⁽³⁾⁽⁴⁾		–	–	0.06	UI
T _{J500}	Total jitter ⁽³⁾⁽⁴⁾	500 Mb/s ⁽⁹⁾	–	–	0.10	UI
D _{J500}	Deterministic jitter ⁽³⁾⁽⁴⁾		–	–	0.03	UI

Notes:

- Using same REFCLK input with TX phase alignment enabled for up to four fully populated GTH Quads at maximum line rate.
- Using QPLL_FBDIV = 40, 40-bit internal data width. These values are NOT intended for protocol specific compliance determinations.
- Using CPLL_FBDIV = 2, 40-bit internal data width. These values are NOT intended for protocol specific compliance determinations.
- All jitter values are based on a bit-error ratio of 10⁻¹².
- CPLL frequency at 2.0 GHz and TXOUT_DIV = 1
- CPLL frequency at 3.2 GHz and TXOUT_DIV = 2.
- CPLL frequency at 2.5 GHz and TXOUT_DIV = 2.
- CPLL frequency at 2.5 GHz and TXOUT_DIV = 4.
- CPLL frequency at 2.0 GHz and TXOUT_DIV = 4.

Table 58: GTH Transceiver Receiver Switching Characteristics

Symbol	Description	Condition	Min	Typ	Max	Units
F _{GTHRX}	Serial data rate		0.500	–	F _{GTHMAX}	Gb/s
T _{RXELECIDLE}	Time for RXELEC_IDLE to respond to loss or restoration of data		–	10	–	ns
R _{XOVBVDP}	OOB detect threshold peak-to-peak		60	–	150	mV
R _{XSST}	Receiver spread-spectrum tracking ⁽¹⁾	Modulated at 33 kHz	–5000	–	0	ppm
R _{XRL}	Run length (CID)		–	–	256	UI
R _{XPPMTOL}	Data/REFCLK PPM offset tolerance	Bit rates ≤ 6.6 Gb/s	–1250	–	1250	ppm
		Bit rates > 6.6 Gb/s and ≤ 8.0 Gb/s	–700	–	700	ppm
		Bit rates > 8.0 Gb/s	–200	–	200	ppm
SJ Jitter Tolerance⁽²⁾						
J _{T_SJ16.3}	Sinusoidal jitter (QPLL) ⁽³⁾	16.3 Gb/s	0.30	–	–	UI
J _{T_SJ15}	Sinusoidal jitter (QPLL) ⁽³⁾	15.0 Gb/s	0.30	–	–	UI
J _{T_SJ14.1}	Sinusoidal jitter (QPLL) ⁽³⁾	14.1 Gb/s	0.30	–	–	UI
J _{T_SJ13.1}	Sinusoidal jitter (QPLL) ⁽³⁾	13.1 Gb/s	0.30	–	–	UI
J _{T_SJ12.5}	Sinusoidal jitter (QPLL) ⁽³⁾	12.5 Gb/s	0.30	–	–	UI
J _{T_SJ11.3}	Sinusoidal jitter (QPLL) ⁽³⁾	11.3 Gb/s	0.30	–	–	UI
J _{T_SJ10.3_QPLL}	Sinusoidal jitter (QPLL) ⁽³⁾	10.3 Gb/s	0.30	–	–	UI
J _{T_SJ10.3_CPLL}	Sinusoidal jitter (CPLL) ⁽³⁾	10.3 Gb/s	0.30	–	–	UI
J _{T_SJ9.8}	Sinusoidal jitter (QPLL) ⁽³⁾	9.8 Gb/s	0.30	–	–	UI
J _{T_SJ8.0_QPLL}	Sinusoidal jitter (QPLL) ⁽³⁾	8.0 Gb/s	0.44	–	–	UI



Table 58: GTH Transceiver Receiver Switching Characteristics (Cont'd)

Symbol	Description	Condition	Min	Typ	Max	Units
J _{T_SJ8.0_CPLL}	Sinusoidal jitter (CPLL) ⁽³⁾	8.0 Gb/s	0.42	–	–	UI
J _{T_SJ6.6_CPLL}	Sinusoidal jitter (CPLL) ⁽³⁾	6.6 Gb/s	0.44	–	–	UI
J _{T_SJ5.0}	Sinusoidal jitter (CPLL) ⁽³⁾	5.0 Gb/s	0.44	–	–	UI
J _{T_SJ4.25}	Sinusoidal jitter (CPLL) ⁽³⁾	4.25 Gb/s	0.44	–	–	UI
J _{T_SJ4.0L}	Sinusoidal jitter (CPLL) ⁽³⁾	4.0 Gb/s ⁽⁴⁾	0.45	–	–	UI
J _{T_SJ3.75}	Sinusoidal jitter (CPLL) ⁽³⁾	3.75 Gb/s	0.44	–	–	UI
J _{T_SJ3.2}	Sinusoidal jitter (CPLL) ⁽³⁾	3.2 Gb/s ⁽⁵⁾	0.45	–	–	UI
J _{T_SJ2.5}	Sinusoidal jitter (CPLL) ⁽³⁾	2.5 Gb/s ⁽⁶⁾	0.50	–	–	UI
J _{T_SJ1.25}	Sinusoidal jitter (CPLL) ⁽³⁾	1.25 Gb/s ⁽⁷⁾	0.50	–	–	UI
J _{T_SJ500}	Sinusoidal jitter (CPLL) ⁽³⁾	500 Mb/s	0.40	–	–	UI
SJ Jitter Tolerance with Stressed Eye⁽²⁾						
J _{T_TJSE3.2}	Total jitter with stressed eye ⁽⁸⁾	3.2 Gb/s	0.70	–	–	UI
J _{T_TJSE6.6}		6.6 Gb/s	0.70	–	–	UI
J _{T_SJSE3.2}	Sinusoidal jitter with stressed eye ⁽⁸⁾	3.2 Gb/s	0.10	–	–	UI
J _{T_SJSE6.6}		6.6 Gb/s	0.10	–	–	UI

Notes:

- Using RXOUT_DIV = 1, 2, and 4.
- All jitter values are based on a bit error ratio of 10⁻¹².
- The frequency of the injected sinusoidal jitter is 10 MHz.
- CPLL frequency at 2.0 GHz and RXOUT_DIV = 1
- CPLL frequency at 3.2 GHz and RXOUT_DIV = 2.
- CPLL frequency at 2.5 GHz and RXOUT_DIV = 2.
- CPLL frequency at 2.5 GHz and RXOUT_DIV = 4.
- Composite jitter with RX equalizer enabled. DFE disabled.



GTH Transceiver Electrical Compliance

The *UltraScale Architecture GTH Transceiver User Guide* ([UG576](#)) contains recommended use modes that ensure compliance for the protocols listed in [Table 59](#). The transceiver wizard provides the recommended settings for those use cases and for protocol specific characteristics.

Table 59: GTH Transceiver Protocol List

Protocol	Specification	Serial Rate (Gb/s)	Electrical Compliance
CAUI-10	IEEE 802.3-2012	10.3125	Compliant
nPPI	IEEE 802.3-2012	10.3125	Compliant
10GBASE-KR	IEEE 802.3-2012	10.3125	Compliant
SFP+	SFF-8431 (SR and LR)	9.95328–11.10	Compliant
XFP	INF-8077i, revision 4.5	10.3125	Compliant
RXAUI	CEI-6G-SR	6.25	Compliant
5.0G Ethernet	IEEE 802.3bx (PAR)	5.0	Compliant
QSGMII	QSGMII v1.2 (Cisco Systems, ENG-46158)	5.0	Compliant
XAU1	IEEE 802.3-2012	3.125	Compliant
2.5G Ethernet	IEEE 802.3bx (PAR)	2.5	Compliant
1000BASE-X	IEEE 802.3-2012	1.25	Compliant
OTU2	ITU G.8251	10.709225	Compliant
OTU4 (OTL4.10)	OIF-CEI-11G-SR	11.180997	Compliant
OC-3/12/48/192	GR-253-CORE	0.1555–9.956	Compliant
Interlaken	OIF-CEI-6G, OIF-CEI-11G-SR	4.25–12.5	Compliant
PCIe Gen1, 2, 3	PCI Express Base 3.0	2.5, 5.0, and 8.0	Compliant
UHD-SDI ⁽¹⁾	SMPTE ST-2081 6G, SMPTE St-2082 12G	6 and 12	Compliant
SDI ⁽¹⁾	SMPTE 424M-2006	0.27–2.97	Compliant
Hybrid Memory Cube (HMC)	HMC-15G-SR	12.5 and 15.0	Compliant
CPRI	CPRI_v_6_1_2014-07-01	0.6144–12.165	Compliant
HDMI ⁽²⁾	HDMI 2.0	All	Compliant
Passive Optical Network (PON)	10G-EPON, 1G-EPON, NG-PON2, XG-PON, and 2.5G-PON	0.155–10.3125	Compliant
JESD204a/b	OIF-CEI-6G, OIF-CEI-11G	3.125–12.5	Compliant
Serial RapidIO	RapidIO Specification 3.1	1.25–10.3125	Compliant
DisplayPort (Source Only)	DP 1.2B CTS	1.62–5.4	Compliant
Fibre Channel	FC-PI-4	1.0625–14.025	Compliant
SATA Gen1, 2, 3	Serial ATA Revision 3.0 Specification	1.5, 3.0, and 6.0	Compliant
SAS Gen1, 2, 3	T10/BSR INCITS 519	3.0, 6.0, and 12.0	Compliant
SFI-5	OIF-SFI5-01.0	0.625–12.5	Compliant

Notes:

- SDI protocols require external circuitry to achieve compliance.
- HDMI protocols require external circuitry to achieve compliance.



GTH Transceiver Protocol Jitter Characteristics

For [Table 60](#) through [Table 65](#), the *UltraScale Architecture GTH Transceiver User Guide* ([UG576](#)) contains recommended settings for optimal usage of protocol specific characteristics.

Table 60: Gigabit Ethernet Protocol Characteristics (GTH Transceivers)

Description	Line Rate (Mb/s)	Min	Max	Units
Gigabit Ethernet Transmitter Jitter Generation				
Total transmitter jitter (T _{TJ})	1250	–	0.24	UI
Gigabit Ethernet Receiver High Frequency Jitter Tolerance				
Total receiver jitter tolerance	1250	0.749	–	UI

Table 61: XAUI Protocol Characteristics (GTH Transceivers)

Description	Line Rate (Mb/s)	Min	Max	Units
XAUI Transmitter Jitter Generation				
Total transmitter jitter (T _{TJ})	3125	–	0.35	UI
XAUI Receiver High Frequency Jitter Tolerance				
Total receiver jitter tolerance	3125	0.65	–	UI

Table 62: PCI Express Protocol Characteristics (GTH Transceivers)⁽¹⁾

Standard	Description	Condition	Line Rate (Mb/s)	Min	Max	Units
PCI Express Transmitter Jitter Generation						
PCI Express Gen 1	Total transmitter jitter		2500	–	0.25	UI
PCI Express Gen 2	Total transmitter jitter		5000	–	0.25	UI
PCI Express Gen 3 ⁽²⁾	Total transmitter jitter uncorrelated		8000	–	31.25	ps
	Deterministic transmitter jitter uncorrelated			–	12	ps
PCI Express Receiver High Frequency Jitter Tolerance						
PCI Express Gen 1	Total receiver jitter tolerance		2500	0.65	–	UI
PCI Express Gen 2 ⁽²⁾	Receiver inherent timing error		5000	0.40	–	UI
	Receiver inherent deterministic timing error			0.30	–	UI
PCI Express Gen 3 ⁽²⁾	Receiver sinusoidal jitter tolerance	0.03 MHz–1.0 MHz	8000	1.00	–	UI
		1.0 MHz–10 MHz		Note 3	–	UI
		10 MHz–100 MHz		0.10	–	UI

Notes:

1. Tested per card electromechanical (CEM) methodology.
2. Using common REFCLK.
3. Between 1 MHz and 10 MHz the minimum sinusoidal jitter roll-off with a slope of 20 dB/decade.



Table 63: CEI-6G and CEI-11G Protocol Characteristics (GTH Transceivers)

Description	Line Rate (Mb/s)	Interface	Min	Max	Units
CEI-6G Transmitter Jitter Generation					
Total transmitter jitter ⁽¹⁾	4976–6375	CEI-6G-SR	–	0.3	UI
		CEI-6G-LR	–	0.3	UI
CEI-6G Receiver High Frequency Jitter Tolerance					
Total receiver jitter tolerance ⁽¹⁾	4976–6375	CEI-6G-SR	0.6	–	UI
		CEI-6G-LR	0.95	–	UI
CEI-11G Transmitter Jitter Generation					
Total transmitter jitter ⁽²⁾	9950–11100	CEI-11G-SR	–	0.3	UI
		CEI-11G-LR/MR	–	0.3	UI
CEI-11G Receiver High Frequency Jitter Tolerance					
Total receiver jitter tolerance ⁽²⁾	9950–11100	CEI-11G-SR	0.65	–	UI
		CEI-11G-MR	0.65	–	UI
		CEI-11G-LR	0.825	–	UI

Notes:

1. Tested at most commonly used line rate of 6250 Mb/s using 390.625 MHz reference clock.
2. Tested at line rate of 9950 Mb/s using 155.46875 MHz reference clock and 11100 Mb/s using 173.4375 MHz reference clock.

Table 64: SFP+ Protocol Characteristics (GTH Transceivers)

Description	Line Rate (Mb/s)	Min	Max	Units
SFP+ Transmitter Jitter Generation				
Total transmitter jitter	9830.40 ⁽¹⁾	–	0.28	UI
	9953.00			
	10312.50			
	10518.75			
	11100.00			
SFP+ Receiver Frequency Jitter Tolerance				
Total receiver jitter tolerance	9830.40 ⁽¹⁾	0.7	–	UI
	9953.00			
	10312.50			
	10518.75			
	11100.00			

Notes:

1. Line rated used for CPRI over SFP+ applications.



Table 65: CPRI Protocol Characteristics (GTH Transceivers)

Description	Line Rate (Mb/s)	Min	Max	Units
CPRI Transmitter Jitter Generation				
Total transmitter jitter	614.4	–	0.35	UI
	1228.8	–	0.35	UI
	2457.6	–	0.35	UI
	3072.0	–	0.35	UI
	4915.2	–	0.3	UI
	6144.0	–	0.3	UI
	9830.4	–	Note 1	UI
CPRI Receiver Frequency Jitter Tolerance				
Total receiver jitter tolerance	614.4	0.65	–	UI
	1228.8	0.65	–	UI
	2457.6	0.65	–	UI
	3072.0	0.65	–	UI
	4915.2	0.95	–	UI
	6144.0	0.95	–	UI
	9830.4	Note 1	–	UI

Notes:

1. Tested per SFP+ specification, see [Table 64](#).



GTY Transceiver Specifications (XCKU095 and XQKU095)

GTY Transceiver DC Input and Output Levels (XCKU095 and XQKU095)

Table 66 summarizes the DC specifications of the GTY transceivers in the XCKU095 and XQKU095 devices (only). Consult www.xilinx.com/products/technology/high-speed-serial for further details.

Table 66: GTY Transceiver DC Specifications

Symbol	DC Parameter	Conditions	Min	Typ	Max	Units
D _{VPPIN}	Differential peak-to-peak input voltage (external AC coupled)	> 10.3125 Gb/s	150	–	1250	mV
		6.6 Gb/s to 10.3125 Gb/s	150	–	1250	mV
		≤ 6.6 Gb/s	150	–	2000	mV
V _{IN}	Single-ended input voltage. Voltage measured at the pin referenced to GND	DC coupled V _{MGTAVTT} = 1.2V	–400	–	V _{MGTAVTT}	mV
V _{CMIN}	Common mode input voltage	DC coupled V _{MGTAVTT} = 1.2V	–	2/3 V _{MGTAVTT}	–	mV
D _{VPPOUT}	Differential peak-to-peak output voltage ⁽¹⁾	Transmitter output swing is set to 0x1F	800	–	–	mV
V _{CMOUTDC}	Common mode output voltage: DC coupled (equation based)	When remote RX is terminated to GND	$V_{MGTAVTT}/2 - D_{VPPOUT}/4$			mV
		When remote RX termination is floating	$V_{MGTAVTT} - D_{VPPOUT}/2$			mV
		When remote RX is terminated to V _{RX_TERM} ⁽²⁾	$V_{MGTAVTT} - \frac{D_{VPPOUT}}{4} - \left(\frac{V_{MGTAVTT} - V_{RX_TERM}}{2}\right)$			mV
V _{CMOUTAC}	Common mode output voltage: AC coupled	Equation based	$V_{MGTAVTT} - D_{VPPOUT}/2$			mV
R _{IN}	Differential input resistance		–	100	–	Ω
R _{OUT}	Differential output resistance		–	100	–	Ω
T _{OSKEW}	Transmitter output pair (TXP and TXN) intra-pair skew		–	–	5	ps
C _{EXT}	Recommended external AC coupling capacitor ⁽³⁾		–	100	–	nF

Notes:

- The output swing and pre-emphasis levels are programmable using the GTY transceiver attributes and can result in values lower than reported in this table.
- V_{RX_TERM} is the remote RX termination voltage.
- Other values can be used as appropriate to conform to specific protocols and standards.

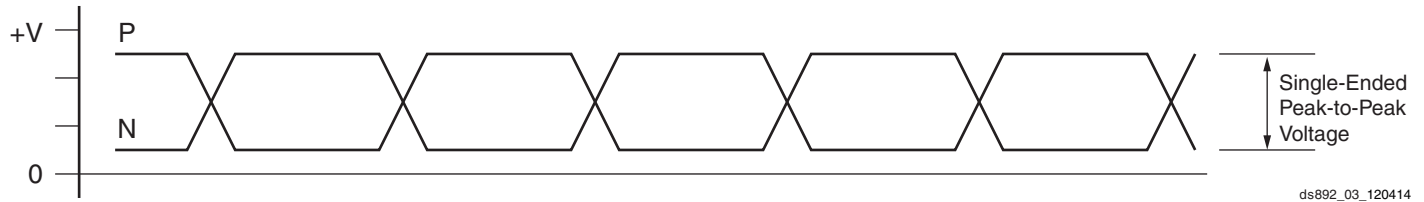

Figure 6: Single-Ended Peak-to-Peak Voltage

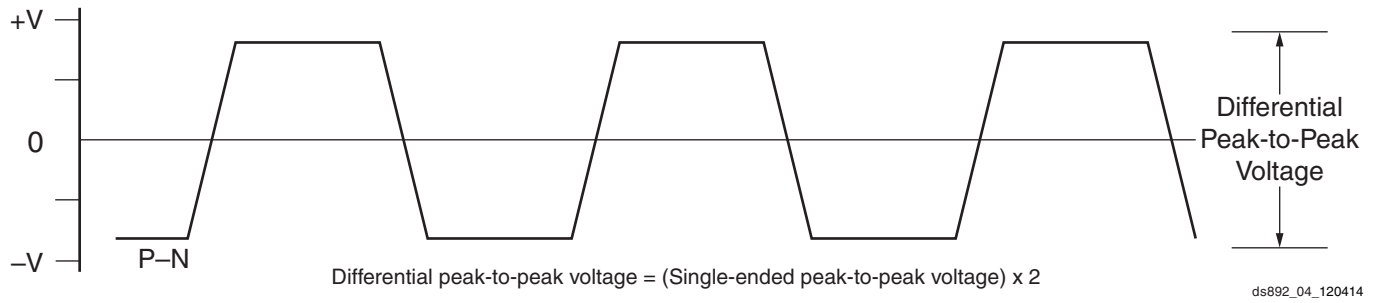

Figure 7: Differential Peak-to-Peak Voltage

Table 67 summarizes the DC specifications of the clock input of the GTY transceivers in the XCKU095 and XQKU095 devices (only). Consult www.xilinx.com/products/technology/high-speed-serial for further details.

Table 67: GTY Transceiver Clock DC Input Level Specification

Symbol	DC Parameter	Min	Typ	Max	Units
V_{IDIFF}	Differential peak-to-peak input voltage	250	–	2000	mV
R_{IN}	Differential input resistance	–	100	–	Ω
C_{EXT}	Required external AC coupling capacitor	–	10	–	nF

Table 68: GTY Transceiver Clock Output Level Specification

Symbol	Description	Conditions	Min	Typ	Max	Units
V_{OL}	Output Low voltage for P and N	$R_T = 100\Omega$ across P and N signals	–	400	–	mV
V_{OH}	Output High voltage for P and N	$R_T = 100\Omega$ across P and N signals	–	760	–	mV
V_{DDOUT}	Differential output voltage (P–N), P = High (N–P), N = High	$R_T = 100\Omega$ across P and N signals	–	± 360	–	mV
V_{CMOUT}	Common mode voltage	$R_T = 100\Omega$ across P and N signals	–	580	–	mV



GTY Transceiver Switching Characteristics for the XCKU095 and XQKU095

Consult www.xilinx.com/products/technology/high-speed-serial for further information.

Table 69: GTY Transceiver Performance

Symbol	Description	Output Divider	Speed Grades and Temperature Range				Units
			-2E, -2I		-1C, -1I, -1M		
F _{GTMAX}	GTY maximum line rate		16.375		12.5		Gb/s
F _{GTMIN}	GTY minimum line rate		0.5		0.5		Gb/s
			Min	Max	Min	Max	
F _{GTYCRANGE}	CPLL line rate range ⁽¹⁾	1	4.0	12.5	4.0	8.5	Gb/s
		2	2.0	6.25	2.0	4.25	Gb/s
		4	1.0	3.125	1.0	2.125	Gb/s
		8	0.5	1.5625	0.5	1.0625	Gb/s
			Min	Max	Min	Max	
F _{GTYORANGE1}	QPLL0 line rate range	1 ⁽²⁾	9.8	16.375	9.8	12.5	Gb/s
		2 ⁽²⁾	4.9	8.1875	4.9	8.1875	Gb/s
		4 ⁽²⁾	2.45	4.09375	2.45	4.09375	Gb/s
		8 ⁽²⁾	1.225	2.04688	1.225	2.04688	Gb/s
		16 ⁽²⁾	0.6125	1.02344	0.6125	1.02344	Gb/s
			Min	Max	Min	Max	
F _{GTYORANGE2}	QPLL1 line rate range	1 ⁽³⁾	8.0	13.0	8.0	12.5	Gb/s
		2 ⁽³⁾	4.0	6.5	4.0	6.5	Gb/s
		4 ⁽³⁾	2.0	3.25	2.0	3.25	Gb/s
		8 ⁽³⁾	1.0	1.625	1.0	1.625	Gb/s
		16 ⁽³⁾	0.5	0.8125	0.5	0.8125	Gb/s
			Min	Max	Min	Max	
F _{CPLLRANGE}	CPLL frequency range		2.0	6.25	2.0	4.25	GHz
F _{QPLLORANGE}	QPLL0 frequency range		9.8	16.375	9.8	16.375	GHz
F _{QPLL1RANGE}	QPLL1 frequency range		8.0	13.0	8.0	13.0	GHz

Notes:

1. The values listed are the rounded results of the calculated equation $(2 \times \text{CPLL_Frequency}) / \text{Output_Divider}$.
2. The values listed are rounded results from calculated equation $(\text{QPLL0_Frequency}) / \text{Output_Divider}$.
3. The values listed are rounded results from calculated equation $(\text{QPLL1_Frequency}) / \text{Output_Divider}$.

Table 70: GTY Transceiver Dynamic Reconfiguration Port (DRP) Switching Characteristics

Symbol	Description	XCKU095 and XQKU095	Units
F _{GTYDRPCLK}	GTYDRPCLK maximum frequency	250	MHz



Table 71: GTY Transceiver Reference Clock Switching Characteristics

Symbol	Description	Conditions	Min	Typ	Max	Units
F_{GCLK}	Reference clock frequency range		60	–	820	MHz
T_{RCLK}	Reference clock rise time	20% – 80%	–	200	–	ps
T_{FCLK}	Reference clock fall time	80% – 20%	–	200	–	ps
T_{DCREF}	Reference clock duty cycle	Transceiver PLL only	40	50	60	%

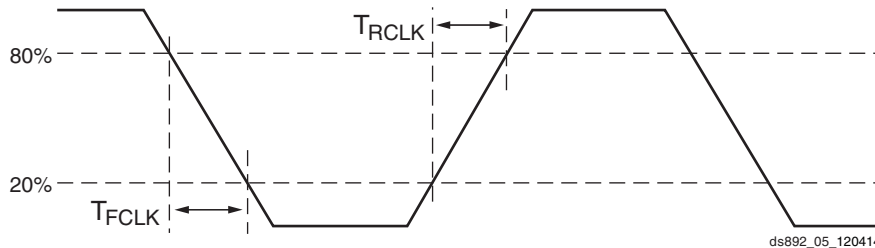

Figure 8: Reference Clock Timing Parameters

Table 72: GTY Transceiver Reference Clock Oscillator Selection Phase Noise Mask⁽¹⁾

Symbol	Description	Offset Frequency	Min	Typ	Max	Units
$QP_{LLREFCLKMASK}$	QP _{LL0} /QP _{LL1} reference clock select phase noise mask at REFCLK frequency = 156.25 MHz	10 kHz	–	–	–112	dBc/Hz
		100 kHz	–	–	–128	
		1 MHz	–	–	–145	
	QP _{LL0} /QP _{LL1} reference clock select phase noise mask at REFCLK frequency = 312.5 MHz	10 kHz	–	–	–103	dBc/Hz
		100 kHz	–	–	–123	
		1 MHz	–	–	–143	
	QP _{LL0} /QP _{LL1} reference clock select phase noise mask at REFCLK frequency = 625 MHz	10 kHz	–	–	–98	dBc/Hz
		100 kHz	–	–	–117	
		1 MHz	–	–	–140	
$CP_{LLREFCLKMASK}$	CP _{LL} reference clock select phase noise mask at REFCLK frequency = 156.25 MHz	10 kHz	–	–	–112	dBc/Hz
		100 kHz	–	–	–128	
		1 MHz	–	–	–145	
		50 MHz	–	–	–145	
	CP _{LL} reference clock select phase noise mask at REFCLK frequency = 312.5 MHz	10 kHz	–	–	–103	dBc/Hz
		100 kHz	–	–	–123	
		1 MHz	–	–	–143	
		50 MHz	–	–	–145	
	CP _{LL} reference clock select phase noise mask at REFCLK frequency = 625 MHz	10 kHz	–	–	–98	dBc/Hz
		100 kHz	–	–	–117	
		1 MHz	–	–	–140	
		50 MHz	–	–	–144	

Notes:

- For reference clock frequencies not in this table, use the phase-noise mask for the nearest reference clock frequency.



Table 73: GTY Transceiver PLL/Lock Time Adaptation

Symbol	Description	Conditions	Min	Typ	Max	Units
T _{LOCK}	Initial PLL lock		–	–	1	ms
T _{DLOCK}	Clock recovery phase acquisition and adaptation time for decision feedback equalizer (DFE)	After the PLL is locked to the reference clock, this is the time it takes to lock the clock data recovery (CDR) to the data present at the input	–	50,000	37 x 10 ⁶	UI
	Clock recovery phase acquisition and adaptation time for low-power mode (LPM) when the DFE is disabled		–	50,000	2.3 x 10 ⁶	UI

Table 74: GTY Transceiver User Clock Switching Characteristics⁽¹⁾

Symbol	Description	Data Width Conditions (Bit)		Speed Grades and Temperature Ranges		Units
		Internal Logic	Interconnect Logic	-2E, -2I	-1C, -1I, -1M	
F _{TXOUTPMA}	TXOUTCLK maximum frequency sourced from OUTCLKPMA			511.719	390.625	MHz
F _{RXOUTPMA}	RXOUTCLK maximum frequency sourced from OUTCLKPMA			511.719	390.625	MHz
F _{TXOUTPROGDIV}	TXOUTCLK maximum frequency sourced from TXPROGDIVCLK			511.719	511.719	MHz
F _{RXOUTPROGDIV}	RXOUTCLK maximum frequency sourced from RXPROGDIVCLK			511.719	511.719	MHz
F _{TXIN}	TXUSRCLK maximum frequency	16	16, 32	511.719	390.625	MHz
		32	32, 64	511.719	390.625	MHz
		20	20, 40	409.375	312.500	MHz
		40	40, 80	409.375	312.500	MHz
F _{RXIN}	RXUSRCLK maximum frequency	16	16, 32	511.719	390.625	MHz
		32	32, 64	511.719	390.625	MHz
		20	20, 40	409.375	312.500	MHz
		40	40, 80	409.375	312.500	MHz
F _{TXIN2}	TXUSRCLK2 maximum frequency	16	16	511.719	390.625	MHz
		20	20	409.375	312.500	MHz
		16, 32	32	511.719	390.625	MHz
		20, 40	40	409.375	312.500	MHz
		32	64	255.860	195.313	MHz
		40	80	204.688	156.250	MHz
F _{RXIN2}	RXUSRCLK2 maximum frequency	16	16	511.719	390.625	MHz
		20	20	409.375	312.500	MHz
		16, 32	32	511.719	390.625	MHz
		20, 40	40	409.375	312.500	MHz
		32	64	255.860	195.313	MHz
		40	80	204.688	156.250	MHz

Notes:

1. Clocking must be implemented as described in the *UltraScale Architecture GTY Transceiver User Guide* ([UG578](#)).



Table 75: GTY Transceiver Transmitter Switching Characteristics

Symbol	Description	Condition	Min	Typ	Max	Units
F_{GTYTX}	Serial data rate range		0.500	–	F_{GTYMAX}	Gb/s
T_{RTX}	TX rise time	20%–80%	–	21	–	ps
T_{FTX}	TX fall time	80%–20%	–	21	–	ps
T_{LLSKEW}	TX lane-to-lane skew ⁽¹⁾		–	–	500	ps
$V_{TXOVBVDP}$	Electrical idle amplitude		–	–	15	mV
$T_{TXOVBTRANSITION}$	Electrical idle transition time		–	–	140	ns
$T_{J16.375_OPLL}$	Total jitter ⁽²⁾⁽⁴⁾	16.375 Gb/s	–	–	0.28	UI
$D_{J16.375_OPLL}$	Deterministic jitter ⁽²⁾⁽⁴⁾		–	–	0.17	UI
$T_{J15.0_OPLL}$	Total jitter ⁽²⁾⁽⁴⁾	15.0 Gb/s	–	–	0.28	UI
$D_{J15.0_OPLL}$	Deterministic jitter ⁽²⁾⁽⁴⁾		–	–	0.17	UI
$T_{J14.1_OPLL}$	Total jitter ⁽²⁾⁽⁴⁾	14.1 Gb/s	–	–	0.28	UI
$D_{J14.1_OPLL}$	Deterministic jitter ⁽²⁾⁽⁴⁾		–	–	0.17	UI
$T_{J14.025_OPLL}$	Total jitter ⁽²⁾⁽⁴⁾	14.025 Gb/s	–	–	0.28	UI
$D_{J14.025_OPLL}$	Deterministic jitter ⁽²⁾⁽⁴⁾		–	–	0.17	UI
$T_{J13.1_OPLL}$	Total jitter ⁽²⁾⁽⁴⁾	13.1 Gb/s	–	–	0.28	UI
$D_{J13.1_OPLL}$	Deterministic jitter ⁽²⁾⁽⁴⁾		–	–	0.17	UI
$T_{J12.5_OPLL}$	Total jitter ⁽²⁾⁽⁴⁾	12.5 Gb/s	–	–	0.28	UI
$D_{J12.5_OPLL}$	Deterministic jitter ⁽²⁾⁽⁴⁾		–	–	0.17	UI
$T_{J12.5_CPLL}$	Total jitter ⁽²⁾⁽⁴⁾	12.5 Gb/s	–	–	0.33	UI
$D_{J12.5_CPLL}$	Deterministic jitter ⁽²⁾⁽⁴⁾		–	–	0.17	UI
$T_{J11.3_OPLL}$	Total jitter ⁽²⁾⁽⁴⁾	11.3 Gb/s	–	–	0.28	UI
$D_{J11.3_OPLL}$	Deterministic jitter ⁽²⁾⁽⁴⁾		–	–	0.17	UI
$T_{J10.3125_OPLL}$	Total jitter ⁽²⁾⁽⁴⁾	10.3125 Gb/s	–	–	0.28	UI
$D_{J10.3125_OPLL}$	Deterministic jitter ⁽²⁾⁽⁴⁾		–	–	0.17	UI
$T_{J10.3125_CPLL}$	Total jitter ⁽³⁾⁽⁴⁾	10.3125 Gb/s	–	–	0.33	UI
$D_{J10.3125_CPLL}$	Deterministic jitter ⁽³⁾⁽⁴⁾		–	–	0.17	UI
$T_{J9.953_OPLL}$	Total jitter ⁽²⁾⁽⁴⁾	9.953 Gb/s	–	–	0.28	UI
$D_{J9.953_OPLL}$	Deterministic jitter ⁽²⁾⁽⁴⁾		–	–	0.17	UI
$T_{J9.8_OPLL}$	Total jitter ⁽²⁾⁽⁴⁾	9.8 Gb/s	–	–	0.28	UI
$D_{J9.8_OPLL}$	Deterministic jitter ⁽²⁾⁽⁴⁾		–	–	0.17	UI
$T_{J8.0_OPLL}$	Total jitter ⁽²⁾⁽⁴⁾	8.0 Gb/s	–	–	0.28	UI
$D_{J8.0_OPLL}$	Deterministic jitter ⁽²⁾⁽⁴⁾		–	–	0.17	UI
$T_{J8.0_CPLL}$	Total jitter ⁽³⁾⁽⁴⁾	8.0 Gb/s	–	–	0.32	UI
$D_{J8.0_CPLL}$	Deterministic jitter ⁽³⁾⁽⁴⁾		–	–	0.17	UI
$T_{J6.6_CPLL}$	Total jitter ⁽³⁾⁽⁴⁾	6.6 Gb/s	–	–	0.30	UI
$D_{J6.6_CPLL}$	Deterministic jitter ⁽³⁾⁽⁴⁾		–	–	0.15	UI
$T_{J5.0}$	Total jitter ⁽³⁾⁽⁴⁾	5.0 Gb/s	–	–	0.30	UI
$D_{J5.0}$	Deterministic jitter ⁽³⁾⁽⁴⁾		–	–	0.15	UI
$T_{J4.25}$	Total jitter ⁽³⁾⁽⁴⁾	4.25 Gb/s	–	–	0.30	UI
$D_{J4.25}$	Deterministic jitter ⁽³⁾⁽⁴⁾		–	–	0.15	UI



Table 75: GTY Transceiver Transmitter Switching Characteristics (Cont'd)

Symbol	Description	Condition	Min	Typ	Max	Units
T _{J4.00L}	Total jitter ⁽³⁾⁽⁴⁾	4.00 Gb/s	–	–	0.32	UI
D _{J4.00L}	Deterministic jitter ⁽³⁾⁽⁴⁾		–	–	0.16	UI
T _{J3.75}	Total jitter ⁽³⁾⁽⁴⁾	3.75 Gb/s	–	–	0.20	UI
D _{J3.75}	Deterministic jitter ⁽³⁾⁽⁴⁾		–	–	0.10	UI
T _{J3.20}	Total jitter ⁽³⁾⁽⁴⁾	3.20 Gb/s ⁽⁵⁾	–	–	0.20	UI
D _{J3.20}	Deterministic jitter ⁽³⁾⁽⁴⁾		–	–	0.10	UI
T _{J2.5}	Total jitter ⁽³⁾⁽⁴⁾	2.5 Gb/s ⁽⁶⁾	–	–	0.20	UI
D _{J2.5}	Deterministic jitter ⁽³⁾⁽⁴⁾		–	–	0.10	UI
T _{J1.25}	Total jitter ⁽³⁾⁽⁴⁾	1.25 Gb/s ⁽⁷⁾	–	–	0.15	UI
D _{J1.25}	Deterministic jitter ⁽³⁾⁽⁴⁾		–	–	0.05	UI
T _{J500}	Total jitter ⁽³⁾⁽⁴⁾	500 Mb/s	–	–	0.10	UI
D _{J500}	Deterministic jitter ⁽³⁾⁽⁴⁾		–	–	0.05	UI

Notes:

- Using same REFCLK input with TX phase alignment enabled for up to four fully-populated GTY Quads at maximum line rate.
- Using QPLL_FBDIV = 40, 20-bit internal data width. These values are NOT intended for protocol specific compliance determinations.
- Using CPLL_FBDIV = 2, 20-bit internal data width. These values are NOT intended for protocol specific compliance determinations.
- All jitter values are based on a bit-error ratio of 10⁻¹².
- CPLL frequency at 3.2 GHz and TXOUT_DIV = 2.
- CPLL frequency at 2.5 GHz and TXOUT_DIV = 2.
- CPLL frequency at 2.5 GHz and TXOUT_DIV = 4.

Table 76: GTY Transceiver Receiver Switching Characteristics

Symbol	Description	Condition	Min	Typ	Max	Units
F _{GTYRX}	Serial data rate		0.500	–	F _{GTYMAX}	Gb/s
T _{RXELECIDLE}	Time for RXELECIDLE to respond to loss or restoration of data		–	10	–	ns
R _{XOOBVDPP}	OOB detect threshold peak-to-peak		60	–	150	mV
R _{XSSST}	Receiver spread-spectrum tracking ⁽¹⁾	Modulated at 33 kHz	–5000	–	0	ppm
R _{XRL}	Run length (CID)		–	–	256	UI
R _{XPPMTOL}	Data/REFCLK PPM offset tolerance	Bit rates ≤ 6.6 Gb/s	–1250	–	1250	ppm
		Bit rates > 6.6 Gb/s and ≤ 8.0 Gb/s	–700	–	700	ppm
		Bit rates > 8.0 Gb/s	–200	–	200	ppm
SJ Jitter Tolerance⁽²⁾						
J _{T_SJ16.375}	Sinusoidal jitter (CPLL) ⁽³⁾	16.375 Gb/s	–	–	0.30	UI
J _{T_SJ15.0}	Sinusoidal jitter (CPLL) ⁽³⁾	15.0 Gb/s	–	–	0.30	UI
J _{T_SJ14.1}	Sinusoidal jitter (CPLL) ⁽³⁾	14.1 Gb/s	–	–	0.30	UI
J _{T_SJ13.1}	Sinusoidal jitter (CPLL) ⁽³⁾	13.1 Gb/s	–	–	0.30	UI
J _{T_SJ12.5_QPLL}	Sinusoidal jitter (CPLL) ⁽³⁾	12.5 Gb/s	–	–	0.30	UI
J _{T_SJ12.5_CPLL}	Sinusoidal jitter (CPLL) ⁽³⁾	12.5 Gb/s	–	–	0.30	UI
J _{T_SJ11.3}	Sinusoidal jitter (CPLL) ⁽³⁾	11.3 Gb/s	–	–	0.30	UI
J _{T_SJ10.32_QPLL}	Sinusoidal jitter (CPLL) ⁽³⁾	10.32 Gb/s	–	–	0.30	UI



Table 76: GTY Transceiver Receiver Switching Characteristics (Cont'd)

Symbol	Description	Condition	Min	Typ	Max	Units
J _{T_SJ10.32_CPLL}	Sinusoidal jitter (CPLL) ⁽³⁾	10.32 Gb/s	–	–	0.30	UI
J _{T_SJ9.8}	Sinusoidal jitter (CPLL) ⁽³⁾	9.8 Gb/s	–	–	0.30	UI
J _{T_SJ8.0_OPLL}	Sinusoidal jitter (CPLL) ⁽³⁾	8.0 Gb/s	–	–	0.44	UI
J _{T_SJ8.0_CPLL}	Sinusoidal jitter (CPLL) ⁽³⁾	8.0 Gb/s	–	–	0.42	UI
J _{T_SJ6.6_CPLL}	Sinusoidal jitter (CPLL) ⁽³⁾	6.6 Gb/s	–	–	0.44	UI
J _{T_SJ5.0}	Sinusoidal jitter (CPLL) ⁽³⁾	5.0 Gb/s	–	–	0.44	UI
J _{T_SJ4.25}	Sinusoidal jitter (CPLL) ⁽³⁾	4.25 Gb/s	–	–	0.44	UI
J _{T_SJ4.00L}	Sinusoidal jitter (CPLL) ⁽³⁾	4.0 Gb/s	–	–	0.45	UI
J _{T_SJ3.75}	Sinusoidal jitter (CPLL) ⁽³⁾	3.75 Gb/s	–	–	0.45	UI
J _{T_SJ3.20}	Sinusoidal jitter (CPLL) ⁽³⁾	3.2 Gb/s ⁽⁴⁾	–	–	0.45	UI
J _{T_SJ2.5}	Sinusoidal jitter (CPLL) ⁽³⁾	2.5 Gb/s ⁽⁵⁾	–	–	0.50	UI
J _{T_SJ1.25}	Sinusoidal jitter (CPLL) ⁽³⁾	1.25 Gb/s ⁽⁶⁾	–	–	0.50	UI
J _{T_SJ500}	Sinusoidal jitter (CPLL) ⁽³⁾	500 Mb/s	–	–	0.50	UI
SJ Jitter Tolerance with Stressed Eye⁽²⁾						
J _{T_TJSE3.2}	Total jitter with stressed eye ⁽⁷⁾	3.2 Gb/s	–	–	0.7	UI
J _{T_TJSE6.6}		6.6 Gb/s	–	–	0.7	UI
J _{T_SJSE3.2}	Sinusoidal jitter with stressed eye ⁽⁷⁾	3.2 Gb/s		–	0.7	UI
J _{T_SJSE6.6}		6.6 Gb/s		–	0.7	UI

Notes:

- Using RXOUT_DIV = 1, 2, and 4.
- All jitter values are based on a bit error ratio of 10⁻¹².
- The frequency of the injected sinusoidal jitter is 80 MHz.
- CPLL frequency at 3.2 GHz and RXOUT_DIV = 2.
- CPLL frequency at 2.5 GHz and RXOUT_DIV = 2.
- CPLL frequency at 2.5 GHz and RXOUT_DIV = 4.
- Composite jitter with RX equalizer enabled. DFE disabled.



GTY Transceiver Electrical Compliance for the XCKU095 and XQKU095

The *UltraScale Architecture GTY Transceiver User Guide* ([UG578](#)) contains recommended use modes that ensure compliance for the protocols listed in [Table 77](#). The transceiver wizard provides the recommended settings for those use cases and for protocol specific characteristics.

Table 77: GTY Transceiver Protocol List

Protocol	Specification	Serial Rate (Gb/s)	Electrical Compliance
Interlaken	OIF-CEI-6G, OIF-CEI-11GSR	4.25–12.5	Compliant
CAUI-10	IEEE 802.3-2012	10.3125	Compliant
nPPI	IEEE 802.3-2012	10.3125	Compliant
10GBASE-KR	IEEE 802.3-2012	10.3125	Compliant
SFP+	SFF-8431 (SR and LR)	9.95328–11.10	Compliant
XFP	INF-8077i, Revision 4.5	10.3125	Compliant
RXAUI	CEI-6G-SR	6.25	Compliant
XAUI	IEEE 802.3-2012	3.125	Compliant
1000BASE-X	IEEE 802.3-2012	1.25	Compliant
OTU2	ITU G.8251	10.709225	Compliant
OTU4 (OTL4.10)	OIF-CEI-11G-SR	11.180997	Compliant
OC-3/12/48/192	GR-253-CORE	0.1555–9.956	Compliant
PCIe Gen1, 2, 3	PCI Express Base 3.0	2.5, 5.0, and 8.0	Compliant
SDI	SMPTE 424M-2006	0.27–2.97	Compliant
Hybrid Memory Cube (HMC)	HMC-15G-SR	12.5 and 15.0	Compliant
CPRI	CPRI_v_6_1_2014-07-01	0.6144–12.165	Compliant
Passive Optical Network (PON)	10G-EPON, 1G-EPON, NG-PON2, XG-PON, and 2.5G-PON	0.155–10.3125	Compliant
JESD204a/b	OIF-CEI-6G, OIF-CEI-11G	3.125–12.5	Compliant
Serial RapidIO	RapidIO Specification 3.1	1.25–10.3125	Compliant
DisplayPort (Source Only)	DP 1.2B CTS	1.62–5.4	Compliant
Fibre Channel	FC-PI-4	1.0625–14.025	Compliant
SATA Gen1, 2, 3	Serial ATA Revision 3.0 Specification	1.5, 3.0, and 6.0	Compliant
SAS Gen1, 2, 3	T10/BSR INCITS 519	3.0, 6.0, and 12.0	Compliant
SFI-5	OIF-SFI5-01.0	0.625 - 12.5	Compliant



GTY Transceiver Protocol Jitter Characteristics (XCKU095 and XQKU095)

For [Table 78](#) through [Table 82](#), the *UltraScale Architecture GTY Transceiver User Guide* ([UG578](#)) contains recommended settings for optimal usage of protocol specific characteristics.

Table 78: Gigabit Ethernet Protocol Characteristics (GTY Transceivers)

Description	Line Rate (Mb/s)	Min	Max	Units
Gigabit Ethernet Transmitter Jitter Generation				
Total transmitter jitter (T _{TJ})	1250	–	0.24	UI
Gigabit Ethernet Receiver High Frequency Jitter Tolerance				
Total receiver jitter tolerance	1250	0.749	–	UI

Table 79: XAUI Protocol Characteristics (GTY Transceivers)

Description	Line Rate (Mb/s)	Min	Max	Units
XAUI Transmitter Jitter Generation				
Total transmitter jitter (T _{TJ})	3125	–	0.35	UI
XAUI Receiver High Frequency Jitter Tolerance				
Total receiver jitter tolerance	3125	0.65	–	UI

Table 80: CEI-6G and CEI-11G Protocol Characteristics (GTY Transceivers)

Description	Line Rate (Mb/s)	Interface	Min	Max	Units
CEI-6G Transmitter Jitter Generation					
Total transmitter jitter ⁽¹⁾	4976–6375	CEI-6G-SR	–	0.3	UI
		CEI-6G-LR	–	0.3	UI
CEI-6G Receiver High Frequency Jitter Tolerance					
Total receiver jitter tolerance ⁽¹⁾	4976–6375	CEI-6G-SR	0.6	–	UI
		CEI-6G-LR	0.95	–	UI
CEI-11G Transmitter Jitter Generation					
Total transmitter jitter ⁽²⁾	9950–11100	CEI-11G-SR	–	0.3	UI
		CEI-11G-LR/MR	–	0.3	UI
CEI-11G Receiver High Frequency Jitter Tolerance					
Total receiver jitter tolerance ⁽²⁾	9950–11100	CEI-11G-SR	0.65	–	UI
		CEI-11G-MR	0.65	–	UI
		CEI-11G-LR	0.825	–	UI

Notes:

1. Tested at most commonly used line rate of 6250 Mb/s using 390.625 MHz reference clock.
2. Tested at line rate of 9950 Mb/s using 155.46875 MHz reference clock and 11100 Mb/s using 173.4375 MHz reference clock.



Table 81: SFP+ Protocol Characteristics (GTY Transceivers)

Description	Line Rate (Mb/s)	Min	Max	Units
SFP+ Transmitter Jitter Generation				
Total transmitter jitter	9830.40 ⁽¹⁾	–	0.28	UI
	9953.00			
	10312.50			
	10518.75			
	11100.00			
SFP+ Receiver Frequency Jitter Tolerance				
Total receiver jitter tolerance	9830.40 ⁽¹⁾	0.7	–	UI
	9953.00			
	10312.50			
	10518.75			
	11100.00			

Notes:

1. Line rated used for CPRI over SFP+ applications.

Table 82: CPRI Protocol Characteristics (GTY Transceivers)

Description	Line Rate (Mb/s)	Min	Max	Units
CPRI Transmitter Jitter Generation				
Total transmitter jitter	614.4	–	0.35	UI
	1228.8	–	0.35	UI
	2457.6	–	0.35	UI
	3072.0	–	0.35	UI
	4915.2	–	0.3	UI
	6144.0	–	0.3	UI
	9830.4	–	Note 1	UI
CPRI Receiver Frequency Jitter Tolerance				
Total receiver jitter tolerance	614.4	0.65	–	UI
	1228.8	0.65	–	UI
	2457.6	0.65	–	UI
	3072.0	0.65	–	UI
	4915.2	0.95	–	UI
	6144.0	0.95	–	UI
	9830.4	Note 1	–	UI

Notes:

1. Tested per SFP+ specification, see [Table 81](#).



Integrated Interface Block for Interlaken for the XCKU095 and XQKU095

More information and documentation on solutions using the integrated interface block for Interlaken can be found at [UltraScale Interlaken](#).

Table 83: Maximum Performance for Interlaken Designs

Symbol	Description	Speed Grades and V_{CCINT} Operating Voltage				Units
		0.95V				
		-2		-1		
$F_{RX_SERDES_CLK}$	Receive serializer/ deserializer clock	195.32		195.32		MHz
$F_{TX_SERDES_CLK}$	Transmit serializer/ deserializer clock	195.32		195.32		MHz
F_{DRP_CLK}	Dynamic reconfiguration port clock	250.00		250.00		MHz
		Min	Max	Min	Max	
F_{CORE_CLK}	Interlaken core clock	300.00	322.27	300.00	322.27	MHz
F_{LBUS_CLK}	Interlaken local bus clock	300.00	322.27	300.00	322.27	MHz

Integrated Interface Block for 100G Ethernet MAC and PCS for the XCKU095 and XQKU095

More information and documentation on solutions using the integrated 100 Gb/s Ethernet block can be found at [UltraScale Integrated 100G Ethernet MAC/PCS](#).

Table 84: Maximum Performance for 100G Ethernet Designs

Symbol	Description	Speed Grades and V_{CCINT} Operating Voltage				Units
		0.95V				
		-2		-1		
F_{TX_CLK}	Transmit clock	322.27		322.27		MHz
F_{RX_CLK}	Receive clock	322.27		322.27		MHz
$F_{RX_SERDES_CLK}$	Receive serializer/deserializer clock	322.27		322.27		MHz
F_{DRP_CLK}	Dynamic reconfiguration port clock	250.00		250.00		MHz



Integrated Interface Block for PCI Express Designs

More information and documentation on solutions for PCI Express designs can be found at [PCI Express](#).

Table 85: Maximum Performance for PCI Express Designs

Symbol	Description	Speed Grades and V _{CCINT} Operating Voltages					Units
		1.0V	0.95V		0.90V		
		-3	-2	-1	-1L	-1L	
F _{PIPECLK}	Pipe clock maximum frequency	250.00	250.00	250.00	250.00	250.00	MHz
F _{CORECLK}	Core clock maximum frequency	500.00	500.00	500.00 ⁽¹⁾	250.00	250.00	MHz
F _{USERCLK}	User clock maximum frequency	250.00	250.00	250.00	250.00	250.00	MHz
F _{DRPCLK}	DRP clock maximum frequency	250.00	250.00	250.00	250.00	250.00	MHz

Notes:

1. PCI Express x8 Gen 3 operation is supported in -2 and -3 speed grades. Refer to the *UltraScale Architecture Gen3 Integrated Block for PCI Express v4.0 User Guide* ([PG156](#)) for information regarding x8 Gen 3 operation in the -1 speed grade.

System Monitor Specifications

Table 86: SYSMON Specifications

Parameter	Symbol	Comments/Conditions	Min	Typ	Max	Units
V _{CCADC} = 1.8V ±3%, V _{REFP} = 1.25V, V _{REFN} = 0V, ADCCLK = 5.2 MHz, T _j = -40°C to 100°C, typical values at T _j = 40°C						
ADC Accuracy⁽¹⁾						
Resolution			10	–	–	Bits
Integral nonlinearity ⁽²⁾	INL		–	–	±2	LSBs
Differential nonlinearity	DNL	No missing codes, guaranteed monotonic	–	–	±1	LSBs
Offset error		Offset calibration enabled	–	–	±2	LSBs
Gain error			–	–	±0.4	%
Sample rate			–	–	0.2	MS/s
RMS code noise		External 1.25V reference	–	–	1	LSBs
		On-chip reference	–	1	–	LSBs
ADC Accuracy at Extended Temperatures						
Resolution		T _j = -55°C to 125°C	10	–	–	Bits
Integral nonlinearity	INL	T _j = -55°C to 125°C	–	–	±2	LSBs
Differential nonlinearity	DNL	No missing codes, guaranteed monotonic T _j = -55°C to 125°C	–	–	±1	



Table 86: SYSMON Specifications (Cont'd)

Parameter	Symbol	Comments/Conditions	Min	Typ	Max	Units
Analog Inputs⁽²⁾						
ADC input ranges		Unipolar operation	0	–	1	V
		Bipolar operation	–0.5	–	+0.5	V
		Unipolar common mode range (FS input)	0	–	+0.5	V
		Bipolar common mode range (FS input)	+0.5	–	+0.6	V
Maximum external channel input ranges		Adjacent channels set within these ranges should not corrupt measurements on adjacent channels	–0.1	–	V _{CCADC}	V
On-Chip Sensor Accuracy						
Temperature sensor error ⁽¹⁾		T _j = –40°C to 100°C (with external REF)	–	–	±4	°C
		T _j = –55°C to 125°C (with external REF)	–	–	±4.5	°C
		T _j = –40°C to 100°C (with internal REF)	–	–	±5	°C
		T _j = –55°C to 125°C (with internal REF)	–	–	±6.5	°C
Supply sensor error ⁽³⁾		T _j = –40°C to 100°C (with external REF)	–	–	±1	%
		T _j = –55°C to 125°C (with external REF)	–	–	±2	%
		T _j = –40°C to 100°C (with internal REF)	–	–	±1.5	%
		T _j = –55°C to 125°C (with internal REF)	–	–	±2.5	%
Conversion Rate⁽⁴⁾						
Conversion time—continuous	t _{CONV}	Number of ADCCLK cycles	26	–	32	Cycles
Conversion time—event	t _{CONV}	Number of ADCCLK cycles	–	–	21	Cycles
DRP clock frequency	DCLK	DRP clock frequency	8	–	250	MHz
ADC clock frequency	ADCCLK	Derived from DCLK	1	–	5.2	MHz
DCLK duty cycle			40	–	60	%
SYSMON Reference⁽⁵⁾						
External reference	V _{REFP}	Externally supplied reference voltage	1.20	1.25	1.30	V
On-chip reference		Ground V _{REFP} pin to AGND, -2 and -3 speed grade T _j = –40°C to 100°C	1.2375	1.25	1.2625	V
		Ground V _{REFP} pin to AGND, -1 and -1L speed grade T _j = –40°C to 100°C	1.23125	1.25	1.26875	V
		Ground V _{REFP} pin to AGND, T _j = –55°C to 125°C	1.225	1.25	1.275	V

Notes:

- ADC offset errors are removed by enabling the ADC automatic offset calibration feature. The values are specified for when this feature is enabled.
- See the *Analog Input* section in the *UltraScale Architecture System Monitor User Guide* ([UG580](#)).
- Supply sensor offset and gain errors are removed by enabling the automatic offset and gain calibration feature. The values are specified for when this feature is enabled.
- See the *Adjusting the Acquisition Settling Time* section in the *UltraScale Architecture System Monitor User Guide* ([UG580](#)).
- Any variation in the reference voltage from the nominal V_{REFP} = 1.25V and V_{REFN} = 0V will result in a deviation from the ideal transfer function. This also impacts the accuracy of the internal sensor measurements (i.e., temperature and power supply). However, for external ratiometric type applications allowing reference to vary by ±4% is permitted.

I2C Interfaces

Table 87: I2C Fast Mode Interface Switching Characteristics⁽¹⁾

Symbol	Description	Min	Typ	Max	Units
T_{DCFLK}	SCL duty cycle	–	50	–	%
T_{FCKO}	SDAO clock-to-out delay	–	–	900	ns
T_{FDCK}	SDAI setup time	100	–	–	ns
F_{FCLK}	SCL clock frequency	–	–	400	kHz

Notes:

- Test conditions: LVCMOS33, slow slew rate, 8 mA drive strength, 15 pF loads.

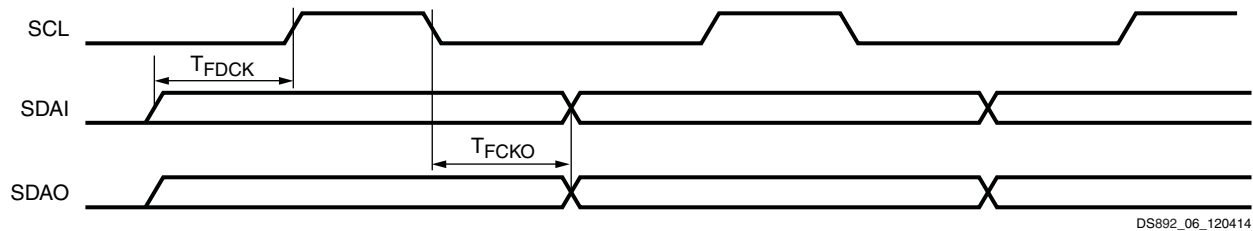

Figure 9: I2C Fast Mode Interface Timing Diagram

Table 88: I2C Standard Mode Interface Switching Characteristics⁽¹⁾

Symbol	Description	Min	Typ	Max	Units
T_{DCSCLK}	SCL duty cycle	–	50	–	%
T_{SCKO}	SDAO clock-to-out delay	–	–	3450	ns
T_{SDCK}	SDAI setup time	250	–	–	ns
F_{SCLK}	SCL clock frequency	–	–	100	kHz

Notes:

- Test conditions: LVCMOS33, slow slew rate, 8 mA drive strength, 15 pF loads.

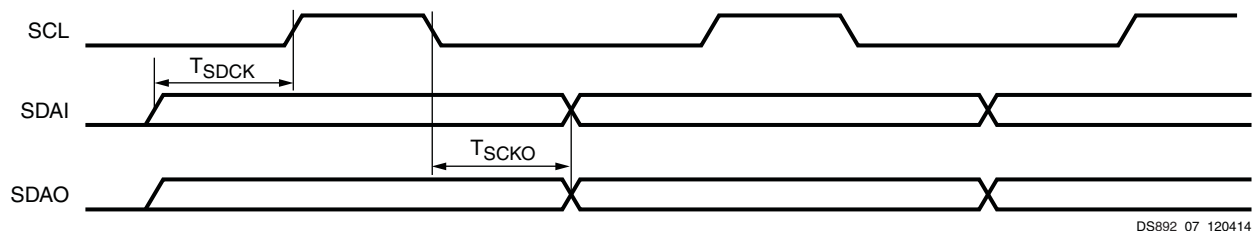

Figure 10: I2C Standard Mode Interface Timing Diagram



Configuration Switching Characteristics

Table 89: Configuration Switching Characteristics

Symbol	Description	Speed Grades and V _{CCINT} Operating Voltages					Units	
		1.0V	0.95V		0.90V			
		-3	-2	-1	-1L	-1L		
Power-up Timing Characteristics								
T _{PL}	Program latency	7.5	7.5	7.5	7.5	7.5	ms, Max	
T _{POR}	Power-on reset (40 ms ramp rate time)	57	57	57	57	57	ms, Max	
		0	0	0	0	0	ms, Min	
	Power-on reset with POR override (2 ms ramp rate time)	15	15	15	15	15	ms, Max	
		5	5	5	5	5	ms, Min	
T _{PROGRAM}	Program pulse width	250	250	250	250	250	ns, Min	
CCLK Output (Master Mode)								
T _{ICCK}	Master CCLK output delay from INIT_B	150	150	150	150	150	ns, Min	
T _{MCCKL} ⁽¹⁾	Master CCLK clock Low time duty cycle	40/60	40/60	40/60	40/60	40/60	%, Min/Max	
T _{MCCKH}	Master CCLK clock High time duty cycle	40/60	40/60	40/60	40/60	40/60	%, Min/Max	
F _{MCCK}	Master CCLK frequency	SPI x2/x4/x8 BPI x8/x16	150	150	150	150	150	MHz, Max
		SPI x1 and serial SLR-based devices	125	125	125	125	125	MHz, Max
		SPI x1 and serial all other devices	150	150	150	150	150	MHz, Max
		SelectMAP	125	125	125	125	125	MHz, Max
F _{MCCK_START}	Master CCLK frequency at start of configuration	3	3	3	3	3	MHz, Typ	
F _{MCCKTOL}	Frequency tolerance, master mode with respect to nominal CCLK	±35	±35	±35	±35	±35	%, Max	
CCLK Input (Slave Modes)								
T _{SCCKL}	Slave CCLK clock minimum Low time	2.5	2.5	2.5	2.5	2.5	ns, Min	
T _{SCCKH}	Slave CCLK clock minimum High time	2.5	2.5	2.5	2.5	2.5	ns, Min	
F _{SCCK}	Slave CCLK frequency	Serial SLR-based	125	125	125	125	125	MHz, Max
		Serial All other devices	150	150	150	150	150	MHz, Max
		SelectMAP	125	125	125	125	125	MHz, Max



Table 89: Configuration Switching Characteristics (Cont'd)

Symbol	Description		Speed Grades and V _{CCINT} Operating Voltages					Units
			1.0V	0.95V		0.90V		
			-3	-2	-1	-1L	-1L	
EMCCLK Input (Master Mode)								
T _{EMCCKL}	External master CCLK Low time		2.5	2.5	2.5	2.5	2.5	ns, Min
T _{EMCCKH}	External master CCLK High time		2.5	2.5	2.5	2.5	2.5	ns, Min
F _{EMCCK}	External master CCLK frequency	SPI x2/x4/x8 BPI x8/x16	150	150	150	150	150	MHz, Max
		SPI x1, Serial SLR-based	125	125	125	125	125	MHz, Max
		SPI x1, Serial All other devices	150	150	150	150	150	MHz, Max
		SelectMAP	125	125	125	125	125	MHz, Max
Internal Configuration Access Port								
F _{ICAPCK}	Internal configuration access port (ICAPE3)	Master SLR ICAP accessing the entire device	125	125	125	125	125	MHz, Max
		SLR ICAP accessing the local SLR	200	200	200	200	200	MHz, Max
		All other devices	200	200	200	200	200	MHz, Max
Master/Slave Serial Mode Programming Switching								
T _{DCCK} /T _{CCKD}	D _{IN} setup/hold		3.0/0	3.0/0	3.0/0	3.0/0	3.0/0	ns, Min
T _{CCO}	D _{OUT} clock to out		8	8	8	8	8	ns, Max
SelectMAP Mode Programming Switching								
T _{SMDCCK} /T _{SMCCKD}	D[31:00] setup/hold		3.5/0	3.5/0	3.5/0	3.5/0	3.5/0	ns, Min
T _{SMCSCCK} /T _{SMCCKCS}	CSI_B setup/hold		4.0/0	4.0/0	4.0/0	4.0/0	4.0/0	ns, Min
T _{SMWCK} /T _{SMCKW}	RDWR_B setup/hold		10.0/0	10.0/0	10.0/0	10.0/0	10.0/0	ns, Min
T _{SMCKCSO}	CSO_B clock to out (330Ω pull-up resistor required)		7	7	7	7	7	ns, Max
T _{SMCO}	D[31:00] clock to out in readback		8	8	8	8	8	ns, Max
F _{RBCK}	Readback frequency	SLR-based	125	125	125	125	125	MHz, Max
		All other devices	125	125	125	125	125	MHz, Max
Boundary-Scan Port Timing Specifications								
T _{TAPTCK} /T _{TCKTAP}	TMS and TDI setup/hold	SLR-based	7.0/ 2.0	7.0/ 2.0	7.0/ 2.0	7.0/ 2.0	7.0/ 2.0	ns, Min
		All other devices	3.0/ 2.0	3.0/ 2.0	3.0/ 2.0	3.0/ 2.0	3.0/ 2.0	ns, Min
T _{TCKTDO}	TCK falling edge to TDO output	SLR-based	10	10	10	10	10	ns, Max
		All other devices	7	7	7	7	7	ns, Max
F _{TCK}	TCK frequency	SLR-based	20	20	20	20	20	MHz, Max
		XCKU095	50	50	50	50	50	MHz, Max
		All other devices	66	66	66	66	66	MHz, Max



Table 89: Configuration Switching Characteristics (Cont'd)

Symbol	Description	Speed Grades and V _{CCINT} Operating Voltages					Units
		1.0V	0.95V		0.90V		
		-3	-2	-1	-1L	-1L	
BPI Master Flash Mode Programming Switching							
T _{BPICCO}	A[28:00], RS[1:0], FCS_B, FOE_B, FWE_B, ADV_B clock to out	10	10	10	10	10	ns, Max
T _{BPIDCC} /T _{BPICCD}	D[15:00] setup/hold	3.5/0	3.5/0	3.5/0	3.5/0	3.5/0	ns, Min
SPI Master Flash Mode Programming Switching							
T _{SPIDCC} /T _{SPICCD}	D[03:00] setup/hold	3.0/0	3.0/0	3.0/0	3.0/0	3.0/0	ns, Min
T _{SPIDCC} /T _{SPICCD}	D[07:04] setup/hold	3.5/0	3.5/0	3.5/0	3.5/0	3.5/0	ns, Min
T _{SPICCM}	MOSI clock to out	8.0	8.0	8.0	8.0	8.0	ns, Max
T _{SPICCM2}	D[04] clock to out	10.0	10.0	10.0	10.0	10.0	ns, Max
T _{SPICFC}	FCS_B clock to out	8.0	8.0	8.0	8.0	8.0	ns, Max
T _{SPICFC2}	FCS2_B clock to out	10.0	10.0	10.0	10.0	10.0	ns, Max
DNA Port Switching							
F _{DNACK}	DNA port frequency	200	200	200	200	200	MHz, Max
STARTUPE3 Ports							
T _{USRCLKO}	STARTUPE3 USRCLKO input port to CCLK pin output delay	1.00/6.00	1.00/6.70	1.00/7.50	1.00/7.50	1.00/7.50	ns, Min/Max
T _{DO}	DO[3:0] ports to D03-D00 pins output delay	1.00/6.70	1.00/7.70	1.00/8.40	1.00/8.40	1.00/8.40	ns, Min/Max
T _{DTS}	DTS[3:0] ports to D03-D00 pins 3-state delays	1.00/7.30	1.00/8.30	1.00/9.00	1.00/9.00	1.00/9.00	ns, Min/Max
T _{FCSBO}	FCSBO port to FCS_B pin output delay	1.00/6.90	1.00/8.00	1.00/8.60	1.00/8.60	1.00/8.60	ns, Min/Max
T _{FCSBTS}	FCSBTS port to FCS_B pin 3-state delay	1.00/6.90	1.00/8.00	1.00/8.60	1.00/8.60	1.00/8.60	ns, Min/Max
T _{USRDONEO}	USRDONEO port to DONE pin output delay	1.00/8.50	1.00/9.60	1.00/10.40	1.00/10.40	1.00/10.40	ns, Min/Max
T _{USRDONETS}	USRDONETS port to DONE pin 3-state delay	1.00/8.50	1.00/9.60	1.00/10.40	1.00/10.40	1.00/10.40	ns, Min/Max
T _{DI}	D03-D00 pins to DI[3:0] ports input delay	0.5/2.6	0.5/3.1	0.5/3.5	0.5/3.5	0.5/3.5	ns, Min/Max
F _{CFGMCLK}	STARTUPE3 CFGMCLK output frequency	50	50	50	50	50	MHz, Typ
F _{CFGMCLKTOL}	STARTUPE3 CFGMCLK output frequency tolerance	±15	±15	±15	±15	±15	%, Max
Startup Timing							
T _{DCI_MATCH}	Specifies a stall in the startup cycle until the digitally controlled impedance (DCI) match signals are asserted	4	4	4	4	4	ms, Max

Notes:

1. When the CCLK is sourced from the EMCCLK pin with a divide-by-one setting, the external EMCCLK must meet this duty-cycle requirement.



eFUSE Programming Conditions

Table 90: eFUSE Programming Conditions⁽¹⁾

Symbol	Description	Min	Typ	Max	Units
I_{FS}	V_{CCAUX} supply current	–	–	115	mA
T_j	Temperature range	–40	–	125	°C

Notes:

- Do not program eFUSE during device configuration (e.g., during configuration, during configuration readback, or when readback CRC is active).

Revision History

The following table shows the revision history for this document.

Date	Version	Description of Revisions
08/20/2025	1.20	Updated IDDR and ODDR bullets in Performance Characteristics section.
09/22/2020	1.19	Added RL package to Table 26 and Table 51 .
05/21/2019	1.18	Added LVDS component mode notes to the Performance Characteristics section.
01/30/2019	1.17	In Table 3 , updated the I_{BATT} Note 4 for additional calculations when designing with XCKU085, XCKU115, and XQKU115 devices. Fixed the spans between speed grade/voltages in Table 45 and Table 46 .
10/30/2018	1.16	Added Note 3 to Table 24 . Added Table 42 . Updated Table 45 . Added Table 46 .
01/08/2018	1.15	In Table 1 , because the voltages are covered in Table 4 , removed the note on V_{IN} for I/O input voltage for HR I/O banks. Added Note 2 to Table 4 . Updated values in Table 26 and added Note 7 . Revised the F_{REFCLK} descriptions in Table 33 . Reduced the typical T_{RTX}/T_{FTX} values in Table 57 . Reduced the typical T_{RTX}/T_{FTX} values in Table 75 . Added $T_{SPICCM2}$ and $T_{SPICCF2}$ to Table 89 .
02/02/2017	1.14	Updated Table 21 and Table 22 to production release for the following devices/speed/temperature grades in the XQ Kintex UltraScale family in Vivado Design Suite 2016.4. XQKU040: -1M, -2I, -2E, -1I (0.95V) devices XQKU060: -1M, -2I, -2E, -1I (0.95V) devices XQKU095: -1M, -2I, -2E, -1I (0.95V) devices XQKU115: -2I, -2E, -1I (0.95V) devices Updated Table 24 with clarifications to the SDR minimums. Updated $MMCM_F_{DRPCLK_MAX}$ in Table 36 and $PLL_F_{DRPCLK_MAX}$ in Table 37 .
12/22/2016	1.13	The Vivado Design Suite version is updated to the latest version listed in Table 20 (either v1.23 or v1.24). Per the <i>Kintex UltraScale and Virtex UltraScale FPGA Speed Specification Changes</i> (XCN16031), Table 22 changes the minimum speed specification versions for designing with devices listed in this data sheet per the design advisory answer record AR68169: Design Advisory for Kintex UltraScale FPGAs and Virtex UltraScale FPGAs—New minimum production speed specification version (Speed File) required for all designs . Added the XQ devices to applicable tables including Table 20 , Table 21 , and Table 22 . Clarified the maximum I_{DC} and T_{SOL} in Table 1 . Updated I_L in Table 3 to include XQ devices. Added HP and HR minimum values to Table 23 and Table 24 . Added T_{MINPER_CLK} and Note 1 to Table 33 . Added $MMCM_F_{DRPCLK_MAX}$ to Table 36 and $PLL_F_{DRPCLK_MAX}$ to Table 37 . In the Table 51 package type row, added SF for -3 and -2 speed specifications. This information is already reflected in the <i>UltraScale Architecture and Product Overview</i> (DS890). Added Table 68 . Updated the Automotive Applications Disclaimer .



Date	Version	Description of Revisions
04/01/2016	1.12	<p>Updated Table 20, Table 21, and Table 22 to production release in Vivado Design Suite 2016.1 of the following devices/speed/temperature grades. With these changes, the XC Kintex UltraScale family is production released.</p> <p>XCKU085: -1L (0.95V) and -1L (0.90V) devices XCKU115: -1L (0.95V) and -1L (0.90V) devices</p> <p>In Table 26, added LPDDR3, updated the package fields, increased the DDR4 and DDR3L memory PHY rates in the FBVA676/ SFVA784 packages, added LRDIMMs to the notes, and removed Note 7. In addition, the QDRIV-XP is only for HP I/O banks. Updated V_{MEAS} for LVCMOS and LVTTTL in Table 30. In Table 32, added the Block RAM and FIFO Clock-to-Out Delays section. Added Table 72.</p>
12/16/2015	1.11	<p>Updated the Power-On/Off Power Supply Sequencing section. Updated Table 20 to speed specification 2015.4.1. Increased the F_{GTHMAX} for -1LI (0.90V) in Table 51 and added Note 1. Updated the -1LI (0.90V) column in Table 56.</p>
11/24/2015	1.10.1	<p>Updated Table 20, Table 21, and Table 22 to production release of the following devices/speed grades.</p> <p>XCKU060: -3E and -1L (0.90V) devices XCKU085: -3E devices XCKU115: -3E devices XCKU035: all speed grades in the SFVA784 package XCKU040: all speed grades in the SFVA784 package</p> <p>Added Note 2 to Table 22.</p> <p>Updated Table 38 through Table 44 with speed specifications for Vivado Design Suite 2015.4.</p> <p>In Table 47, added the value for package skew on the XCKU095 FFVA1156.</p>
10/12/2015	1.9	<p>Updated data in Table 6 (XCKU025, XCKU085, and XCKU095) and Table 7 (XCKU095). Updated the description in Power-On/Off Power Supply Sequencing.</p> <p>Updated Table 21 and Table 22 to production release of the following devices/speed grades.</p> <p>XCKU025: -1C/-1I and -2E/-2I devices XCKU035: -1LI (0.95V) and -1LI (0.90V) XCKU040: -1LI (0.95V) and -1LI (0.90V) XCKU060: -1LI (0.95V) XCKU085: -1C/-1I and -2E/-2I devices XCKU095: -1C/-1I and -2E/-2I devices</p> <p>Updated Table 20, Table 21, Table 22, Table 32, Table 33, Table 34, Table 38 through Table 44, and Table 89 with speed specifications for Vivado Design Suite 2015.3.</p> <p>Updated Table 47 with package skew data.</p> <p>Added protocols to Table 59. Updated $V_{CMOUTDC}$ in Table 66. Added data to Table 75 and Table 76.</p> <p>Added Startup Timing to Table 89.</p>



Date	Version	Description of Revisions
09/22/2015	1.8	<p>Added GTY tables to support the XCKU095. Added the XCKU025 device.</p> <p>In Table 2, revised the -1L (0.90V) V_{CCINT} and V_{CCINT_IO} for a recommended $\pm 20\text{mV}$ power supply operating range. Updated description of I_{CCADC}.</p> <p>Updated Table 21 and Table 22 to production release of the -1 and -2 speed grade XCKU115 devices and production release of the -3 speed grade for the XCKU035 and XCKU040 devices.</p> <p>Updated Table 20, Table 21, Table 22, Table 32, Table 34, Table 38 through Table 44, and Table 89 with speed specifications for Vivado Design Suite 2015.2.1.</p> <p>Updated Table 26 with more delineated values including adding package variations.</p> <p>In Table 47 added the XCKU095 FFVA1156 package and updated skew values.</p> <p>Updated protocols in Table 59.</p> <p>Revised the values in Table 83 and removed Note 1. Updated Table 86: Sample rate.</p> <p>In Table 89, added further delineation between devices (SLR-based, XCKU095, and all other devices), added values by speed grade, and updated -1L specifications.</p>
08/03/2015	1.7	<p>Updated and added device information in Table 7. In Table 18 and Table 19 updated Note 2, Note 3, and Note 4.</p> <p>Updated Table 21 and Table 22 to production release of the -1 and -2 speed grade XCKU060 devices.</p> <p>Updated Table 20, Table 21, Table 22, Table 32, Table 34, Table 38 through Table 44, and Table 89 with speed specifications for Vivado Design Suite 2015.2 v1.17.</p> <p>Added Table 54: GTH Transceiver Reference Clock Oscillator Selection Phase Noise Mask. Added the GTH Transceiver Electrical Compliance section.</p> <p>Revised $F_{CORECLK}$ and Note 1 in Table 85. Updated the STARTUPE3 Ports descriptions in Table 89. Updated Note 1 in Table 90.</p>
05/12/2015	1.6	<p>The minimum software requirements changed for KU040 requiring Vivado Design Suite 2015.1 v1.15 per the design advisory answer record AR64347: <i>Design Advisory for UltraScale Speed Specification - 2015.1 Production Speed Specification Changes</i>. This includes revisions to Table 20, Table 21, Table 22, Table 27, Table 28, and Table 38 to Table 44. Also, in Table 29, revised the HR I/O values for $T_{OUTBUF_DELAY_TE_PAD}$ and added Note 1.</p> <p>Updated Table 21 and Table 22 to production release of the XCKU035 devices in the FBVA676 and FFVA1156 packages. Added Note 2 to Table 3. Clarifying edits to Table 30 and Table 31. Added Note 1 to Table 83. Updated the On-Chip Sensor Accuracy in Table 86. In Table 89, added more specifications to the STARTUPE3 Ports section.</p>



Date	Version	Description of Revisions
02/24/2015	1.5	<p>In Table 1, added I_{DC} and I_{RMS} and updates to the GTH and GTY Transceivers $I_{DCIN/OUT}$ section including adding Note 8.</p> <p>Added many specifications and recommended values to Table 3. Updated specifications in Table 4, Table 5, and Table 6. Added Table 7. Revised the V_{OCM} maximum for MINI_LVDS_25 and RSDS_25 in Table 12. Revised the V_{ICM} specifications in Table 14. Removed rows from Table 16 and Table 17. Removed V_{OH} and V_{OL} rows, revised the V_{OCM} maximum, and revised V_{ICM} in Table 18. Removed V_{OH} and V_{OL} rows and revised V_{ICM} in Table 19.</p> <p>Updated the following tables specifically addressing FBVA900 design specifications: Table 21, Table 22, Table 47, and Table 51. Removed Table 27.</p> <p>Updated Table 20, Table 21, Table 22, Table 27, and Table 28 with speed specifications for Vivado Design Suite 2014.4.1.</p> <p>Completely revised the Performance Characteristics section including adding Table 23, Table 24, and Table 25, updating Table 26 (including Note 7), and removing Table 27: <i>Maximum Physical Interface (PHY) Rate for Memory Interfaces (FBV Packages)</i>. Added the section: <i>I/O Standard Adjustment Measurement Methodology</i>. Revised F_{REFCLK} in Table 33. Revised $MMCM_T_{LOCKMAX}$ in Table 36. Revised the F_{INMAX} in Table 36 and Table 37. Updated Table 45. Updated devices listed, packages listed, and package skew in Table 47. Updated $V_{CMOUTDC}$ and D_{VPPOUT} in Table 48. Added Table 50. Table 51. Added new values and descriptions to both Table 57 and Table 58. Updated the F_{DRP_CLK} in Table 83, Table 84, and Table 85. Added to F_{CORE_CLK} and $F_{USERCLK}$ Table 83. Updated On-chip reference and Note 5 in Table 86. Updated the F_{EMCCK}, F_{SCCK}, F_{MCCK}, T_{POR}, and $T_{USRCLKO}$ specifications in Table 89.</p>
11/14/2014	1.4	<p>Updated Note 2 and Note 3 in Table 1 and Note 3, Note 4, and Note 6 in Table 2. Updated Note 3 in Table 6. Revised the Power-On/Off Power Supply Sequencing section. Updated the descriptions in Table 8. Removed Note 1 from both Table 26 and Table 27. Revised DDR3 specification for FBVA900 package -2I speed grade in Table 27. Updated Table 20, Table 27, and Table 28 with speed specifications for Vivado Design Suite 2014.3. Updated the descriptions in Table 37. Added a discussion on the data in the device pin-to-pin parameter tables on page 41 and page 44. Revised the values for F_{LBUS_CLK} in Table 83. Updated Note 5 in Table 86. In Table 89, added more speed specifications, updated T_{PL}, $F_{MCCKTOL}$, and F_{RBCK}, added the <i>STARTUPE3 Ports</i> section, and added Note 1.</p>
07/10/2014	1.3	<p>Updated LVDCI_15 information in Table 10. Revised the SLVS_400 values in Table 12.</p> <p>Updated Table 20 and all the tables relevant to the latest speed specification Vivado 2014.2 v1.08.</p> <p>Removed RLDRAM II from Table 26 and Table 27. Also added FBV Package to Table 27. Removed $T_{DELAY_RST_RDY}$ from Table 33. Revised $MMCM_F_{INDUTY}$ in Table 36 and PLL_F_{INDUTY} in Table 37. Updated the V_{IN} description in Table 48. Updated Figure 3 and Figure 4. Updated Note 1 in Table 57. Added two new sections for the Integrated Interface Block for Interlaken for the XCKU095 and XQKU095 and the Integrated Interface Block for 100G Ethernet MAC and PCS for the XCKU095 and XQKU095.</p>
05/16/2014	1.2	<p>Updated Note 2, added I_{OL} and I_{OH} specifications, and added Note 3 and Note 4 to Table 9 and Table 10. In Table 12, revised the MINI_LVDS_25 and RSDS_25 maximum value for V_{OCM} and added SLVS_400 specifications. In Table 13 and Table 14, Added the I_{OL} and I_{OH} specifications. Removed the POD standards from Table 10 and Table 14.</p> <p>Updated the AC Switching Characteristics section and Table 20 based upon the Vivado Design Suite 2014.1 v1.06 speed specifications. Updated $T_{PW_WF_NC}$ in Table 32. Revised $MMCM_T_{FBDELAY}$ in Table 36, and added $PLL_F_{BANDWIDTH}$ to Table 37. Updated format and notes in Table 43 and Table 44.</p> <p>Revised notes in Table 51. Updated value for $F_{GTHDRPCLK}$ in Table 52. Updated the 0.90V values for $F_{TXOUTPROGDIV}$ and $F_{RXOUTPROGDIV}$ in Table 56, and the corresponding F_{MAX} in Table 35. In Table 86, updated On-Chip Sensor Accuracy section, removed Gain error conditions, updated Note 1, and added Note 3.</p> <p>In Table 89, revised T_{POR} specifications and updated F_{MCCK}, F_{SCCK}, F_{ICAPCK}, F_{RBCK}, T_{TAPTCK}/T_{TCKTAP}, T_{TCKTDO}, and F_{TCK}.</p>



Date	Version	Description of Revisions
04/09/2014	1.1	<p>Added I_{DC} and I_{RMS} to Table 1.</p> <p>In Table 3, updated the programmable input termination resistance sections (R), added Note 5 and Note 6, and added the Internal V_{REF} and Differential termination specifications.</p> <p>In Table 8, updated Note 3.</p> <p>Revised the LVC MOS15 V_{OH}/V_{OL} specifications in Table 9 and Table 10. In Table 12, removed support for SUB_LVDS_25 and revised the V_{OCM} values. Instead SUB_LVDS will be supported in both HR and HP I/O banks. Replaced SUB_LVDS_25 in Table 27 with SUB_LVDS.</p> <p>In Table 26, split the -2 speed specifications by temperature range and updated the DDR3 and RLDRAM III specifications. In Table 27, updated the -1 and -3 speed grade maximum specifications for DDR4. Updated the speed specifications in Table 27 and Table 28.</p> <p>Removed Table 24: CLB Switching Characteristics which contained F_{TOG} (the toggle frequency). Revised Table 32 including adding $T_{PW_WF_NC}$, T_{PW_RF}, and Note 1. Updated Table 33 especially F_{REFCLK}, T_{MINPER_RST}, and the IDELAY/ODELAY chain resolution. Replaced all the tables in the Clock Buffers and Networks section with Table 35. Updated the $MMCM_F_{PFDMAX}$ in Table 36. Updated the PLL_F_{PFDMAX} and the $PLL_T_{OUTDUTY}$ in Table 37.</p> <p>Changed the D_{VPP_OUT} value to minimum in Table 48. Updated the typical C_{EXT} value in Table 49. In Table 51, increased the $F_{GTHORANGE1}$ maximum for the 16 output dividers in the -1 speed grade, and added Note 2 and Note 3. In Table 56, updated four rows of TXOUTCLK/RXOUTCLK information and removed Note 2, Note 3, and Note 4. Revised the T_{LLSKEW} value and units in Table 57. Updated the notes in Table 62.</p> <p>In Table 86, revised the INL maximum and ADC Accuracy at Extended Temperatures and updated some of the On-Chip Sensor Accuracy maximum values.</p> <p>Revised F_{MCK} and updated the ramp rate for T_{POR} in Table 89.</p>
12/10/2013	1.0	Initial AMD release.



Notice of Disclaimer

The information presented in this document is for informational purposes only and may contain technical inaccuracies, omissions, and typographical errors. The information contained herein is subject to change and may be rendered inaccurate for many reasons, including but not limited to product and roadmap changes, component and motherboard version changes, new model and/or product releases, product differences between differing manufacturers, software changes, BIOS flashes, firmware upgrades, or the like. Any computer system has risks of security vulnerabilities that cannot be completely prevented or mitigated. AMD assumes no obligation to update or otherwise correct or revise this information. However, AMD reserves the right to revise this information and to make changes from time to time to the content hereof without obligation of AMD to notify any person of such revisions or changes. THIS INFORMATION IS PROVIDED "AS IS." AMD MAKES NO REPRESENTATIONS OR WARRANTIES WITH RESPECT TO THE CONTENTS HEREOF AND ASSUMES NO RESPONSIBILITY FOR ANY INACCURACIES, ERRORS, OR OMISSIONS THAT MAY APPEAR IN THIS INFORMATION. AMD SPECIFICALLY DISCLAIMS ANY IMPLIED WARRANTIES OF NON-INFRINGEMENT, MERCHANTABILITY, OR FITNESS FOR ANY PARTICULAR PURPOSE. IN NO EVENT WILL AMD BE LIABLE TO ANY PERSON FOR ANY RELIANCE, DIRECT, INDIRECT, SPECIAL, OR OTHER CONSEQUENTIAL DAMAGES ARISING FROM THE USE OF ANY INFORMATION CONTAINED HEREIN, EVEN IF AMD IS EXPRESSLY ADVISED OF THE POSSIBILITY OF SUCH DAMAGES.

Automotive Applications Disclaimer

AUTOMOTIVE PRODUCTS (IDENTIFIED AS "XA" IN THE PART NUMBER) ARE NOT WARRANTED FOR USE IN THE DEPLOYMENT OF AIRBAGS OR FOR USE IN APPLICATIONS THAT AFFECT CONTROL OF A VEHICLE ("SAFETY APPLICATION") UNLESS THERE IS A SAFETY CONCEPT OR REDUNDANCY FEATURE CONSISTENT WITH THE ISO 26262 AUTOMOTIVE SAFETY STANDARD ("SAFETY DESIGN"). CUSTOMER SHALL, PRIOR TO USING OR DISTRIBUTING ANY SYSTEMS THAT INCORPORATE PRODUCTS, THOROUGHLY TEST SUCH SYSTEMS FOR SAFETY PURPOSES. USE OF PRODUCTS IN A SAFETY APPLICATION WITHOUT A SAFETY DESIGN IS FULLY AT THE RISK OF CUSTOMER, SUBJECT ONLY TO APPLICABLE LAWS AND REGULATIONS GOVERNING LIMITATIONS ON PRODUCT LIABILITY.

© Copyright 2013–2025 Advanced Micro Devices, Inc. AMD, the AMD Arrow logo, Kintex, UltraScale, Vivado, and combinations thereof are trademarks of Advanced Micro Devices, Inc. PCI, PCIe, and PCI Express are trademarks of PCI-SIG and used under license. Other product names used in this publication are for identification purposes only and may be trademarks of their respective companies.

OUR CERTIFICATE

DiGi provide top-quality products and perfect service for customer worldwide through standardization, technological innovation and continuous improvement. DiGi through third-party certification, we stricly control the quality of products and services. Welcome your RFQ to

Email: Info@DiGi-Electronics.com



Tel: +00 852-30501935

RFQ Email: Info@DiGi-Electronics.com

DiGi is a global authorized distributor of electronic components.