

XCR3128XL-10VQ100I Datasheet

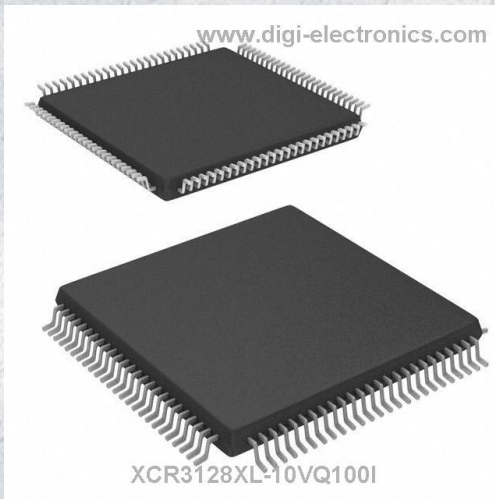

<https://www.DiGi-Electronics.com>

DiGi Electronics Part Number	XCR3128XL-10VQ100I-DG
Manufacturer	AMD
Manufacturer Product Number	XCR3128XL-10VQ100I
Description	IC CPLD 128MC 9.1NS 100VQFP
Detailed Description	Embedded, Integrated Circuits (ICs)



Tel: +00 852-30501935

RFQ Email: Info@DiGi-Electronics.com

DiGi is a global authorized distributor of electronic components.

Purchase and inquiry

Manufacturer Product Number:

XCR3128XL-10VQ100I

Series:

CoolRunner XPLA3

DiGi-Electronics Programmable:

Not Verified

Delay Time tpd(1) Max:

9.1 ns

Number of Logic Elements/Blocks:

8

Number of Gates:

3000

Operating Temperature:

-40°C ~ 85°C (TA)

Package / Case:

100-TQFP

Base Product Number:

XCR3128

Manufacturer:

AMD

Product Status:

Last Time Buy

Programmable Type:

In System Programmable (min 1K program/erase cycles)

Voltage Supply - Internal:

2.7V ~ 3.6V

Number of Macrocells:

128

Number of I/O:

84

Mounting Type:

Surface Mount

Supplier Device Package:

100-VQFP (14x14)

Environmental & Export classification

RoHS Status:

RoHS non-compliant

REACH Status:

REACH Unaffected

HTSUS:

8542.39.0001

Moisture Sensitivity Level (MSL):

3 (168 Hours)

ECCN:

EAR99



XCR3128XL 128 Macrocell CPLD

DS016 (v2.6) March 31, 2006

Product Specification

Features

- Low power 3.3V 128 macrocell CPLD
- 5.5 ns pin-to-pin logic delays
- System frequencies up to 175 MHz
- 128 macrocells with 3,000 usable gates
- Available in small footprint packages
 - 144-pin TQFP (108 user I/O pins)
 - 144-ball CS BGA (108 user I/O)
 - 100-pin VQFP (84 user I/O)
- Optimized for 3.3V systems
 - Ultra low power operation
 - Typical Standby Current of 17 μ A at 25° C
 - 5V tolerant I/O pins with 3.3V core supply
 - Advanced 0.35 micron five layer metal EEPROM process
 - Fast Zero Power™ (FZP) CMOS design technology
 - 3.3V PCI electrical specification compatible outputs (no internal clamp diode on any input or I/O)
- Advanced system features
 - In-system programming
 - Input registers
 - Predictable timing model
 - Up to 23 available clocks per function block
 - Excellent pin retention during design changes
 - Full IEEE Standard 1149.1 boundary-scan (JTAG)
 - Four global clocks
 - Eight product term control terms per function block
- Fast ISP programming times
- Port Enable pin for additional I/O
- 2.7V to 3.6V supply voltage at industrial temperature range
- Programmable slew rate control per output
- Security bit prevents unauthorized access
- Refer to XPLA3 family data sheet ([DS012](#)) for architecture description

Description

The CoolRunner™ XPLA3 XCR3128XL device is a 3.3V 128 macrocell CPLD targeted at power sensitive designs that require leading edge programmable logic solutions. A total of eight function blocks provide 3,000 usable gates. Pin-to-pin propagation delays are as fast as 5.5 ns with a maximum system frequency of 175 MHz.

TotalCMOS Design Technique for Fast Zero Power

CoolRunner XPLA3 CPLDs offer a TotalCMOS™ solution, both in process technology and design technique. Xilinx employs a cascade of CMOS gates to implement its sum of products instead of the traditional sense amp approach. This CMOS gate implementation allows Xilinx CPLDs to offer devices that are both high performance and low power, breaking the paradigm that to have low power, you must have low performance. Refer to [Figure 1](#) or [Figure 2](#) and [Table 1](#) or [Table 2](#) showing the I_{CC} vs. Frequency of the XCR3128XL TotalCMOS CPLD (data taken with eight resettable up/down, 16-bit counters at 3.3V, 25°C).

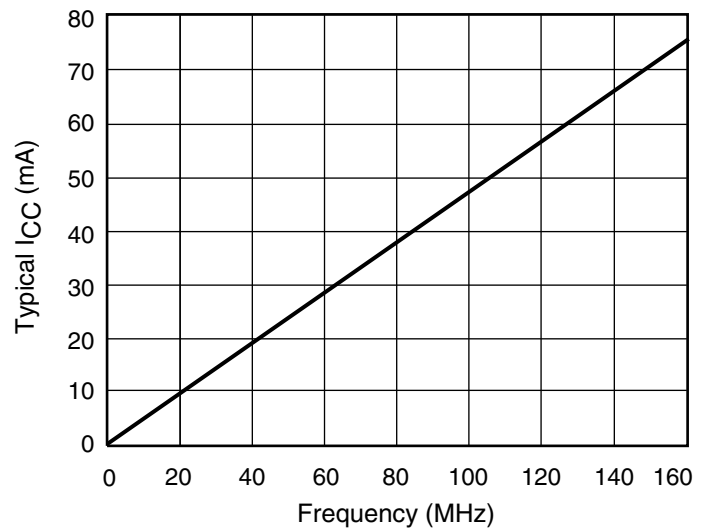

Figure 1: Typical I_{CC} vs. Frequency at $V_{CC} = 3.3V, 25^{\circ}C$

Table 1: Typical I_{CC} vs. Frequency at $V_{CC} = 3.3V, 25^{\circ}C$

Frequency (MHz)	0	1	5	10	20	40	60	80	100	120	140	160
Typical I_{CC} (mA)	0.017	0.5	2.48	4.97	9.89	19.7	29.5	39.1	48.7	58.0	67.3	76.8

DC Electrical Characteristics Over Recommended Operating Conditions⁽¹⁾

Symbol	Parameter	Test Conditions	Typical	Min.	Max.	Unit
$V_{OH}^{(2)}$	Output High voltage	$V_{CC} = 3.0V$ to $3.6V$, $I_{OH} = -8$ mA		2.4	-	V
		$V_{CC} = 2.7V$ to $3.0V$, $I_{OH} = -8$ mA		2.0	-	V
		$I_{OH} = -500$ μA		90% $V_{CC}^{(3)}$	-	V
V_{OL}	Output Low voltage for 3.3V outputs	$I_{OL} = 8$ mA		-	0.4	V
I_{IL}	Input leakage current	$V_{IN} = GND$ or V_{CC} to 5.5V		-10	10	μA
I_{IH}	I/O High-Z leakage current	$V_{IN} = GND$ or V_{CC} to 5.5V		-10	10	μA
$I_{CCSB}^{(7)}$	Standby current	$V_{CC} = 3.6V$	29	-	100	μA
I_{CC}	Dynamic current ^(4,5)	$f = 1$ MHz		-	1	mA
		$f = 50$ MHz		-	30	mA
C_{IN}	Input pin capacitance ⁽⁶⁾	$f = 1$ MHz		-	8	pF
C_{CLK}	Clock input capacitance ⁽⁶⁾	$f = 1$ MHz		-	12	pF
$C_{I/O}$	I/O pin capacitance ⁽⁶⁾	$f = 1$ MHz		-	10	pF

Notes:

1. See the CoolRunner XPLA3 family data sheet ([DS012](#)) for recommended operating conditions.
2. See [Figure 2](#) for output drive characteristics of the XPLA3 family.
3. This parameter guaranteed by design and characterization, not by testing.
4. See [Table 1](#), Figure 1 for typical values.
5. This parameter measured with a 16-bit, resettable up/down counter loaded into every function block, with all outputs disabled and unloaded. Inputs are tied to V_{CC} or ground. This parameter guaranteed by design and characterization, not testing.
6. Typical values, not tested.
7. Typical value at 70° C.

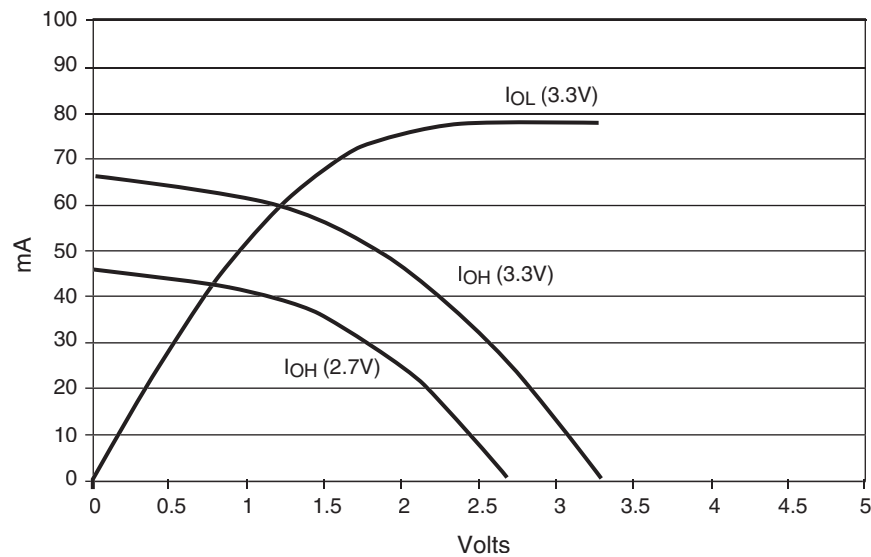

DS012_10_031802

Figure 2: Typical I/V Curve for the CoolRunner XPLA3 Family, 25°C

AC Electrical Characteristics Over Recommended Operating Conditions^(1,2)

Symbol	Parameter	-6		-7		-10		Unit
		Min.	Max.	Min.	Max.	Min.	Max.	
T_{PD1}	Propagation delay time (single p-term)	-	5.5	-	7.0	-	9.1	ns
T_{PD2}	Propagation delay time (OR array) ⁽³⁾	-	6.0	-	7.5	-	10.0	ns
T_{CO}	Clock to output (global synchronous pin clock)	-	4.0	-	5.0	-	6.5	ns
T_{SUF}	Setup time (fast input register)	2.5	-	3.0	-	3.0	-	ns
$T_{SU1}^{(4)}$	Setup time (single p-term)	3.5	-	4.3	-	5.4	-	ns
T_{SU2}	Setup time (OR array)	4.0	-	4.8	-	6.3	-	ns
$T_H^{(4)}$	Hold time	0	-	0	-	0	-	ns
$T_{WLH}^{(4)}$	Global Clock pulse width (High or Low)	2.5	-	3.0	-	4.0	-	ns
$T_{PLH}^{(4)}$	P-term clock pulse width	4.0	-	5.0	-	6.0	-	ns
T_{APRPW}	Asynchronous preset/reset pulse width (High or Low)	4.0	-	5.0	-	6.0	-	ns
$T_R^{(4)}$	Input rise time	-	20	-	20	-	20	ns
$T_L^{(4)}$	Input fall time	-	20	-	20	-	20	ns
$f_{SYSTEM}^{(4)}$	Maximum system frequency	-	175	-	119	-	95	MHz
$T_{CONFIG}^{(4)}$	Configuration time ⁽⁵⁾	-	100	-	100	-	100	μ s
$T_{INIT}^{(4)}$	ISP initialization time	-	100	-	100	-	100	μ s
$T_{POE}^{(4)}$	P-term OE to output enabled	-	7.5	-	9.3	-	11.2	ns
$T_{POD}^{(4)}$	P-term OE to output disabled ⁽⁶⁾	-	7.5	-	9.3	-	11.2	ns
$T_{PCO}^{(4)}$	P-term clock to output	-	7.0	-	8.3	-	10.7	ns
$T_{PAO}^{(4)}$	P-term set/reset to output valid	-	8.0	-	9.3	-	11.2	ns

Notes:

1. Specifications measured with one output switching.
2. See the CoolRunner XPLA3 family data sheet ([DS012](#)) for recommended operating conditions.
3. See [Figure 6](#) for derating.
4. These parameters guaranteed by design and/or characterization, not testing.
5. Typical current draw during configuration is 9 mA at 3.6V.
6. Output $C_L = 5$ pF.

Internal Timing Parameters^(1,2)

Symbol	Parameter	-6		-7		-10		Unit
		Min.	Max.	Min.	Max.	Min.	Max.	
Buffer Delays								
T_{IN}	Input buffer delay	-	1.3	-	1.6	-	2.2	ns
T_{FIN}	Fast Input buffer delay	-	2.3	-	3.0	-	3.1	ns
T_{GCK}	Global Clock buffer delay	-	0.8	-	1.0	-	1.3	ns
T_{OUT}	Output buffer delay	-	2.2	-	2.7	-	3.6	ns
T_{EN}	Output buffer enable/disable delay	-	4.2	-	5.0	-	5.7	ns
Internal Register and Combinatorial Delays								
T_{LDI}	Latch transparent delay	-	1.3	-	1.6	-	2.0	ns
T_{SUI}	Register setup time	1.0	-	1.0	-	1.2	-	ns
T_{HI}	Register hold time	0.3	-	0.5	-	0.7	-	ns

Symbol	Parameter	-6		-7		-10		Unit
		Min.	Max.	Min.	Max.	Min.	Max.	
T _{ECSU}	Register clock enable setup time	2.0	-	2.5	-	3.0	-	ns
T _{ECHO}	Register clock enable hold time	3.0	-	4.5	-	5.5	-	ns
T _{COI}	Register clock to output delay	-	1.0	-	1.3	-	1.6	ns
T _{AOI}	Register async. S/R to output delay	-	2.5	-	2.3	-	2.1	ns
T _{RAI}	Register async. recovery	-	4.0	-	5.0	-	6.0	ns
T _{PTCK}	Product term clock delay	-	2.5	-	2.7	-	3.3	ns
T _{LOGI1}	Internal logic delay (single p-term)	-	2.0	-	2.7	-	3.3	ns
T _{LOGI2}	Internal logic delay (PLA OR term)	-	2.5	-	3.2	-	4.2	ns
Feedback Delays								
T _F	ZIA delay	-	1.2	-	2.9	-	3.5	ns
Time Adders								
T _{LOGI3}	Fold-back NAND delay	-	2.0	-	2.5	-	3.0	ns
T _{UDA}	Universal delay	-	1.7	-	2.2	-	2.7	ns
T _{SLEW}	Slew rate limited delay	-	4.0	-	5.0	-	6.0	ns

Notes:

1. These parameters guaranteed by design and/or characterization, not testing.
2. See the CoolRunner XPLA family data sheet ([DS012](#)) for timing model.

Switching Characteristics

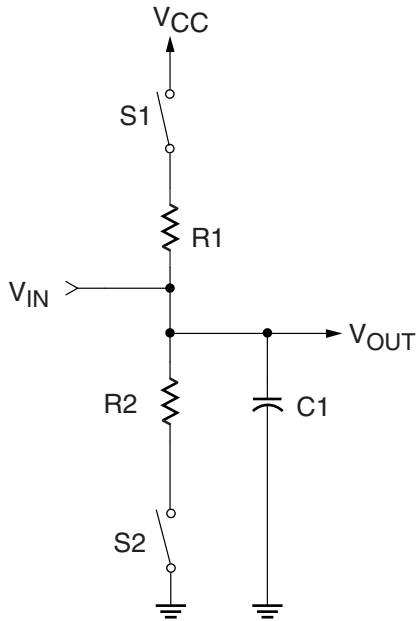

Component	Values
R1	390Ω
R2	390Ω
C1	35 pF

Measurement	S1	S2
T _{POE} (High)	Open	Closed
T _{POE} (Low)	Closed	Open
T _P	Closed	Closed

Note: For T_{POD}, C1 = 5 pF. Delay measured at output level of V_{OL} + 300 mV, V_{OH} - 300 mV.

DS016_03_102401

Figure 3: AC Load Circuit

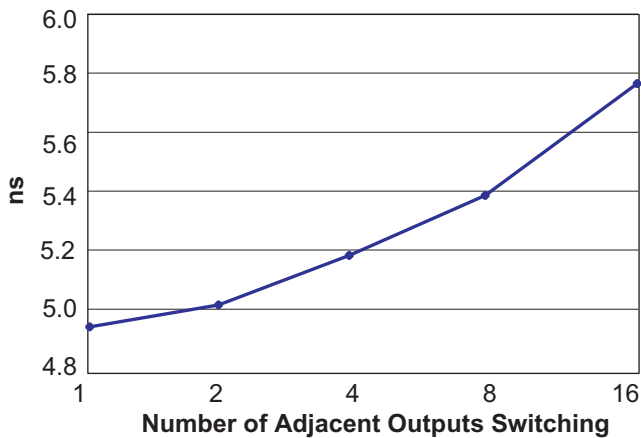

DS016_04a_120902

Figure 4: Derating Curve for T_{PD2}

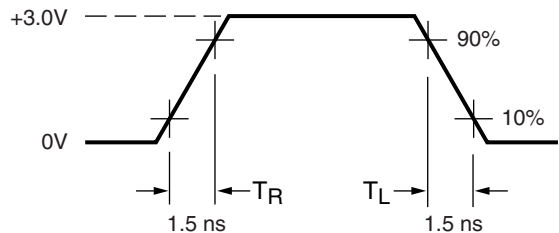

Measurements:
All circuit delays are measured at the +1.5V level of inputs and outputs, unless otherwise specified.

DS016_05_042800

Figure 5: Voltage Waveform

Pin Descriptions

Table 2: XCR3128XL User I/O Pins

	VQ100	CS144	TQ144
Total User I/O Pins	84	108	108

Table 3: XCR3128XL I/O Pins

Function Block	Macrocell	VQ100	CS144	TQ144
1	1	-	B12	106
1	2	73 ⁽¹⁾	D11 ⁽¹⁾	104 ⁽¹⁾
1	3	72	D12	102
1	4	71	D13	101
1	5	70	E10	100
1	6	69	E11	99
1	7	68	E12	98
1	8	-	-	-
1	9	-	-	-
1	10	-	-	-
1	11	67	E13	97
1	12	-	F10	96
1	13	65	F12	94
1	14	64	F13	93
1	15	63	G10	92
1	16	-	G11	91
2	1	75	A13	107
2	2	76	A12	109
2	3	77	B11	110
2	4	78	A11	111
2	5	79	D10	112
2	6	80	C10	113
2	7	81	B10	114
2	8	-	-	-
2	9	-	-	-
2	10	-	-	-
2	11	83	D9	116
2	12	84	C9	117
2	13	85	B9	118
2	14	-	A9	119
2	15	-	D8	120
2	16	-	C8	121

Table 3: XCR3128XL I/O Pins (Continued)

Function Block	Macrocell	VQ100	CS144	TQ144
3	1	-	G13	90
3	2	62 ⁽¹⁾	G12 ⁽¹⁾	89 ⁽¹⁾
3	3	61	H13	88
3	4	60	H12	87
3	5	-	H11	86
3	6	58	J13	84
3	7	57	J12	83
3	8	-	-	-
3	9	-	-	-
3	10	-	-	-
3	11	56	J11	82
3	12	55	J10	81
3	13	54	K13	80
3	14	53	K12	79
3	15	52	K11	78
3	16	-	K10	77
4	1	-	M8	60
4	2	40	L8	61
4	3	41	K8	62
4	4	42	N9	63
4	5	44	L9	65
4	6	45	K9	66
4	7	46	N10	67
4	8	-	-	-
4	9	-	-	-
4	10	-	-	-
4	11	47	M10	68
4	12	48	L10	69
4	13	49	N11	70
4	14	50	M11	71
4	15	-	L11	72
4	16	-	M12	74
5	1	2	A1	1
5	2	1	A2	143
5	3	100	C3	142
5	4	99	B3	141
5	5	98	A3	140

Table 3: XCR3128XL I/O Pins (Continued)

Function Block	Macrocell	VQ100	CS144	TQ144
5	6	97	C4	139
5	7	96	B4	138
5	8	-	-	-
5	9	-	-	-
5	10	-	-	-
5	11	-	A4	137
5	12	-	D5	136
5	13	94	B5	134
5	14	93	A5	133
5	15	92	D6	132
5	16	-	C6	131
6	1	-	B1	2
6	2	4 ⁽¹⁾	D2 ⁽¹⁾	4 ⁽¹⁾
6	3	5	D1	5
6	4	6	E4	6
6	5	7	E3	7
6	6	8	E2	8
6	7	9	E1	9
6	8	-	-	-
6	9	-	-	-
6	10	-	-	-
6	11	10	F4	10
6	12	-	F3	11
6	13	-	F2	12
6	14	12	G2	14
6	15	13	G1	15
6	16	14	G3	16
7	1	-	N7	56
7	2	37	M7	55
7	3	36	N6	54
7	4	35	M6	53
7	5	33	M5	46
7	6	32	L5	45
7	7	31	K5	44
7	8	-	-	-
7	9	-	-	-
7	10	-	-	-

Table 3: XCR3128XL I/O Pins (Continued)

Function Block	Macrocell	VQ100	CS144	TQ144
7	11	30	N4	42
7	12	29	M4	41
7	13	28	L4	40
7	14	27	K4	39
7	15	-	N3	38
7	16	-	M3	37
8	1	-	H1	18
8	2	15 ⁽¹⁾	H2 ⁽¹⁾	20 ⁽¹⁾
8	3	16	H3	21
8	4	17	H4	22
8	5	-	J1	23
8	6	19	J3	25
8	7	20	J4	26
8	8	-	-	-
8	9	-	-	-
8	10	-	-	-
8	11	21	K1	27
8	12	22	K2	28
8	13	23	K3	29
8	14	24	L1	30
8	15	25	M2	31
8	16	-	N1	32

Notes:

1. JTAG pins

Table 4: XCR3128XL Global, JTAG, Port Enable, Power, and No Connect Pins

Pin Type	VQ100	CS144	TQ144
IN0 / CLK0	90	D7	128
IN1 / CLK1	89	C7	127
IN2 / CLK2	88	A7	126
IN3 / CLK3	87	B7	125
TCK	62	G12	89
TDI	4	D2	4
TDO	73	D11	104
TMS	15	H2	20
PORT_EN	11 ⁽¹⁾	F1 ⁽¹⁾	13 ⁽¹⁾
Vcc	3, 18, 34, 39, 51, 66, 82, 91	A10, B2, B6, B8, D4, F11, J2, K6, K7, L13, N5, N12	24, 50, 51, 58, 73, 76, 95, 115, 123, 130, 144

Table 4: XCR3128XL Global, JTAG, Port Enable, Power, and No Connect Pins

Pin Type	VQ100	CS144	TQ144
GND	26, 38, 43, 59, 74, 86, 95	A6, A8, C5, C13, D3, G4, H10, L6, L7, M9, N2, N8	3, 17, 33, 52, 57, 59, 64, 85, 105, 124, 129, 135
No Connects	-	B13, C1, C2, C11, C12, L2, L3, L12, M1, M13, N13	19, 34, 35, 36, 43, 47, 48, 49, 75, 103, 108, 122

Notes:

1. Port Enable is brought High to enable JTAG pins when JTAG pins are used as I/O. See family data sheet ([DS012](#)) for full explanation.

Device Part Marking and Ordering Combination Information

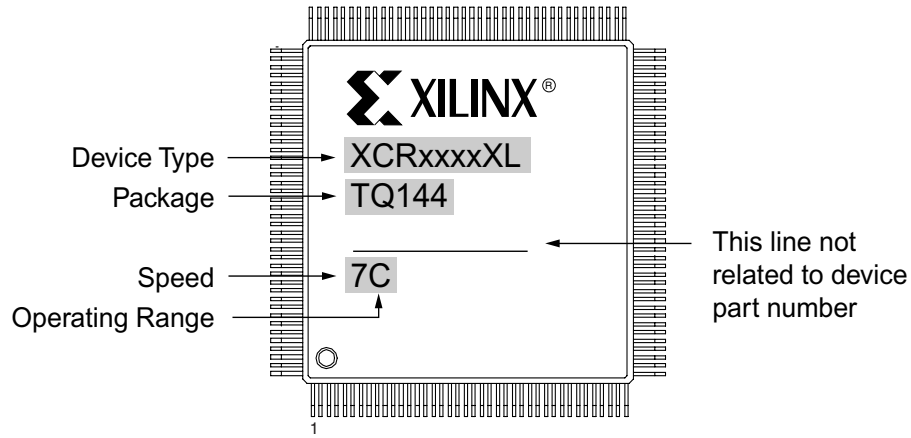

Sample package with part marking.

Device Ordering and Part Marking Number	Speed (pin-to-pin delay)	Pkg. Symbol	No. of Pins	Package Type	Operating Range ⁽¹⁾
XCR3128XL-6VQ100C	6 ns	VQ100	100	Very Thin Quad Flat Package (VQFP)	C
XCR3128XL-6VQG100C	6 ns	VQG100	100	Very Thin Quad Flat Package (VQFP); Pb-Free	C
XCR3128XL-6CS144C	6 ns	CS144	144	Chip Scale Package (CSP)	C
XCR3128XL-6CSG144C	6 ns	CSG144	144	Chip Scale Package (CSP); Pb-Free	C
XCR3128XL-6TQ144C	6 ns	TQ144	144	Thin Quad Flat Pack (TQFP)	C
XCR3128XL-6TQG144C	6 ns	TQG144	144	Thin Quad Flat Pack (TQFP); Pb-Free	C
XCR3128XL-7VQ100C	7.5 ns	VQ100	100	Very Thin Quad Flat Package (VQFP)	C
XCR3128XL-7VQG100C	7.5 ns	VQG100	100	Very Thin Quad Flat Package (VQFP); Pb-Free	C
XCR3128XL-7CS144C	7.5 ns	CS144	144	Chip Scale Package (CSP)	C
XCR3128XL-7CSG144C	7.5 ns	CSG144	144	Chip Scale Package (CSP); Pb-Free	C
XCR3128XL-7TQ144C	7.5 ns	TQ144	144	Thin Quad Flat Pack (TQFP)	C
XCR3128XL-7TQG144C	7.5 ns	TQG144	144	Thin Quad Flat Pack (TQFP); Pb-Free	C
XCR3128XL-7VQ100I	7.5 ns	VQ100	100	Very Thin Quad Flat Package (VQFP)	I
XCR3128XL-7VQG100I	7.5 ns	VQG100	100	Very Thin Quad Flat Package (VQFP); Pb-Free	I
XCR3128XL-7CS144I	7.5 ns	CS144	144	Chip Scale Package (CSP)	I
XCR3128XL-7CSG144I	7.5 ns	CSG144	144	Chip Scale Package (CSP); Pb-Free	I
XCR3128XL-7TQ144I	7.5 ns	TQ144	144	Thin Quad Flat Pack (TQFP)	I
XCR3128XL-7TQG144I	7.5 ns	TQG144	144	Thin Quad Flat Pack (TQFP); Pb-Free	I
XCR3128XL-10VQ100C	10 ns	VQ100	100	Very Thin Quad Flat Package (VQFP)	C
XCR3128XL-10VQG100C	10 ns	VQG100	100	Very Thin Quad Flat Package (VQFP); Pb-Free	C
XCR3128XL-10CS144C	10 ns	CS144	144	Chip Scale Package (CSP)	C
XCR3128XL-10CSG144C	10 ns	CSG144	144	Chip Scale Package (CSP); Pb-Free	C
XCR3128XL-10TQ144C	10 ns	TQ144	144	Thin Quad Flat Pack (TQFP)	C
XCR3128XL-10TQG144C	10 ns	TQG144	144	Thin Quad Flat Pack (TQFP); Pb-Free	C

Device Ordering and Part Marking Number	Speed (pin-to-pin delay)	Pkg. Symbol	No. of Pins	Package Type	Operating Range ⁽¹⁾
XCR3128XL-10VQ100I	10 ns	VQ100	100	Very Thin Quad Flat Package (VQFP)	I
XCR3128XL-10VQG100I	10 ns	VQG100	100	Very Thin Quad Flat Package (VQFP); Pb-Free	I
XCR3128XL-10CS144I	10 ns	CS144	144	Chip Scale Package (CSP)	I
XCR3128XL-10CSG144I	10 ns	CSG144	144	Chip Scale Package (CSP); Pb-Free	I
XCR3128XL-10TQ144I	10 ns	TQ144	144	Thin Quad Flat Pack (TQFP)	I
XCR3128XL-10TQG144I	10 ns	TQG144	144	Thin Quad Flat Pack (TQFP); Pb-Free	I

Notes:

1. C = Commercial: $T_A = 0^\circ$ to $+70^\circ\text{C}$; I = Industrial: $T_A = -40^\circ$ to $+85^\circ\text{C}$

Warranty Disclaimer

THESE PRODUCTS ARE SUBJECT TO THE TERMS OF THE XILINX LIMITED WARRANTY WHICH CAN BE VIEWED AT <http://www.xilinx.com/warranty.htm>. THIS LIMITED WARRANTY DOES NOT EXTEND TO ANY USE OF THE PRODUCTS IN AN APPLICATION OR ENVIRONMENT THAT IS NOT WITHIN THE SPECIFICATIONS STATED ON THE THEN-CURRENT XILINX DATA SHEET FOR THE PRODUCTS. PRODUCTS ARE NOT DESIGNED TO BE FAIL-SAFE AND ARE NOT WARRANTED FOR USE IN APPLICATIONS THAT POSE A RISK OF PHYSICAL HARM OR LOSS OF LIFE. USE OF PRODUCTS IN SUCH APPLICATIONS IS FULLY AT THE RISK OF CUSTOMER SUBJECT TO APPLICABLE LAWS AND REGULATIONS.

Additional Information

[CoolRunner XPLA3 Data Sheets and Application Notes](#)

[Device Package User Guide](#)

[Device Packages](#)

Revision History

The following table shows the revision history for this document.

Date	Version	Revision
04/07/00	1.0	Initial Xilinx release.
05/03/00	1.1	Minor updates and added Boundary Scan to pinout table.
11/20/00	1.2	Updated pinout tables; corrected note in Table 4 to read: "port enable pin is brought High".
12/08/00	1.3	Updated pinout tables.
01/17/01	1.4	Removed Timing Model.
04/11/01	1.5	Added Typical I/V curve, Figure 2 ; added Table 2 : Total User I/O; changed V_{OH} spec.
04/19/01	1.6	Updated Typical I/V curve, Figure 2 : added voltage levels.
08/10/01	1.7	Moved Figure 1 and Table 1 to first page. Changed VQ144 to VQ100 in Table 2 .
01/08/02	1.8	Updated T_{SUF} and T_{FIN} spec to match software timing. Added single p-term setup time (T_{SU1}) to AC Table, renamed T_{SU} to T_{SU2} for setup time through the OR array. Added T_{INIT} spec. Updated T_{CONFIG} spec. Updated T_{HI} spec to correct a typo. Updated AC Load Circuit diagram to more closely resemble true test conditions, added note for T_{POD} delay measurement.
01/27/03	1.9	Updated product availability and AC/DC parameters for -6 Commercial and -7 Industrial devices. Updated T_{PCO} (added T_{PTCK}), T_{CONFIG} , T_{INIT} , T_F . Updated I_{CC} vs. Frequency Curve for -6 device; updated system frequency to 175 MHz; removed Advance Information from -6 device; updated Derating Curve for -6 device. Updated Ordering Information format.

Date	Version	Revision
07/15/03	2.0	Updated test conditions for I_{IL} and I_{IH} .
08/21/03	2.1	Updated Package Device Marking Pin 1 orientation.
02/13/04	2.2	Added soldering temperature. Added links to application notes and data sheets.
07/09/04	2.3	Updated the following specifications based on characterization of product after move to UMC fabrication for all family members: V_{OH} , T_{LOGI3} . Deleted derating curve for T_{PD2} for MOSIV fabricated material.
11/11/04	2.4	Moved from Preliminary Product Specification to Product Specification.
04/08/05	2.5	Added I_{CCSB} Typical and T_{APRPW} specifications. Removed T_{SOL} specification.
03/31/06	2.6	Added Warranty Disclaimer. Added Pb-Free information to ordering table.

OUR CERTIFICATE

DiGi provide top-quality products and perfect service for customer worldwide through standardization, technological innovation and continuous improvement. DiGi through third-party certification, we stricly control the quality of products and services. Welcome your RFQ to

Email: Info@DiGi-Electronics.com



Tel: +00 852-30501935

RFQ Email: Info@DiGi-Electronics.com

DiGi is a global authorized distributor of electronic components.