

# PA2512FKF7W0R006E Datasheet

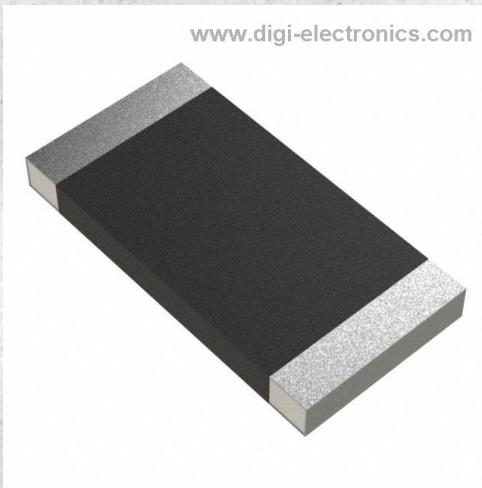

<https://www.DiGi-Electronics.com>

DiGi Electronics Part Number	PA2512FKF7W0R006E-DG
Manufacturer	<a href="#">YAGEO</a>
Manufacturer Product Number	PA2512FKF7W0R006E
Description	RES 0.006 OHM 1% 2W 2512
Detailed Description	6 mOhms ±1% 2W Chip Resistor 2512 (6432 Metric) Automotive AEC-Q200, Current Sense, Moisture Resistant Metal Element

This model PA2512FKF7W0R006E is available at DiGi Electronics.

DiGi Electronics offers a global database of semiconductor and electronic component datasheets.

We welcome your inquiries regarding pricing, lead time, or other product-related questions.

 [Request a Quote](#)

 [Datasheet Search](#)



Tel: +00 852-30501935

RFQ Email: [Info@DiGi-Electronics.com](mailto:Info@DiGi-Electronics.com)

DiGi is a global authorized distributor of electronic components.

## Purchase and inquiry

Manufacturer Product Number:

PA2512FKF7W0R006E

Series:

PA\_E

Resistance:

6 mOhms

Power (Watts):

2W

Features:

Automotive AEC-Q200, Current Sense, Moisture Resistant

Operating Temperature:

-55°C ~ 170°C

Supplier Device Package:

2512

Size / Dimension:

0.250" L x 0.125" W (6.35mm x 3.18mm)

Number of Terminations:

2

Manufacturer:

YAGEO

Product Status:

Active

Tolerance:

±1%

Composition:

Metal Element

Temperature Coefficient:

±100ppm/°C

Package / Case:

2512 (6432 Metric)

Ratings:

AEC-Q200

Height - Seated (Max):

0.035" (0.88mm)

Failure Rate:

-

## Environmental & Export classification

RoHS Status:

ROHS3 Compliant

REACH Status:

REACH Unaffected

HTSUS:

8533.21.0030

Moisture Sensitivity Level (MSL):

1 (Unlimited)

ECCN:

EAR99

# DATA SHEET

**CURRENT SENSOR - LOW TCR  
AUTOMOTIVE GRADE**

PA\_E series

5%, 1%, 0.5%

sizes 2512

RoHS compliant & Halogen free



## SCOPE

This specification describes PA series current sensor - low TCR with lead-free terminations made by metal substrate.

## APPLICATIONS

- Consumer goods
- Computer
- Telecom / Datacom
- Industrial / Power supply
- Alternative Energy
- Car electronics

## FEATURES

- AEC-Q200 qualified
- Halogen-free Epoxy
- RoHS compliant
- Reduce environmentally hazardous wastes
- High component and equipment reliability
- Non-forbidden materials used in products/production
- Low resistances applied to current sensing
- Anti-sulfur

## ORDERING INFORMATION - GLOBAL PART NUMBER

Global part numbers are identified by the series, size, tolerance, packing type, temperature coefficient, taping reel and resistance value.

### GLOBAL PART NUMBER

**PA    XXXX    X    X    X    XX    XXXX    E**  
 (1)    (2) (3) (4)    (5)    (6)    (7)

#### (1) SIZE

2512

#### (2) TOLERANCE

D = ± 0.5%

F = ± 1%

J = ± 5%

#### (3) PACKAGING TYPE

K = Embossed taping reel

#### (4) TEMPERATURE COEFFICIENT OF RESISTANCE

F = ± 100 ppm/°C

M = ± 75 ppm/°C

E = ± 50 ppm/°C

#### (5) TAPING REEL

07 = 7 inch dia. Reel & standard power (1W)

7W = 7 inch dia. Reel & 2 x standard power (2W)

7T = 7 inch dia. Reel & 3 x standard power (3W)

#### (6) RESISTANCE VALUE

0.5 mΩ to 100 mΩ

#### (7) DEFAULT CODE

Letter E is the system default code for ordering only. (Note)

Resistance rule of global part number

Resistance code rule	Example
XUXX	0U5 = 0.5mΩ
0RXXX	0R001 = 1 mΩ
(1 to 100 mΩ)	0R05 = 50 mΩ

### ORDERING EXAMPLE

The ordering code of a PA2512 1W chip resistor, TC100, value 0.003Ω with ±1% tolerance, supplied in 7-inch tape reel is: PA2512FKF070R003E

### NOTE

1. All our RChip products are RoHS compliant. "LFP" of the internal 2D reel label mentions "Lead-Free Process"

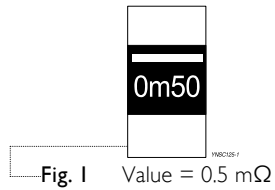
**MARKING****PA2512**

4 digits

The "m" is used as decimal point; the other 3 digits are significant and the unit is milliohm

PA2512: 0.5mΩ and 0.75mΩ

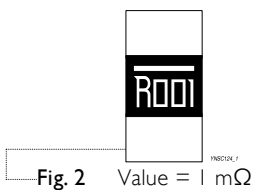

4 digits

The "R" is used as a decimal point; the other 3 digits are significant

PA2512: 1 mΩ to 4 mΩ

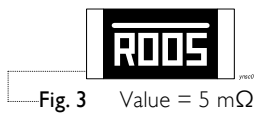

4 digits

The "R" is used as a decimal point; the other 3 digits are significant

PA2512: 5 mΩ to 100 mΩ

**CONSTRUCTION**

The resistors are constructed using outstanding TCR level material, which makes Yageo PA resistors excellent for current sensing application in battery charger circuit & DC-DC converter.

The composition of the resistive material is adjusted to give the approximate required resistance and is covered with a protective coating. Marking is printed on the top side of the resistor.

Finally, the three external terminations (Cu / Ni / matte Tin) are added, as shown in Fig. 4.

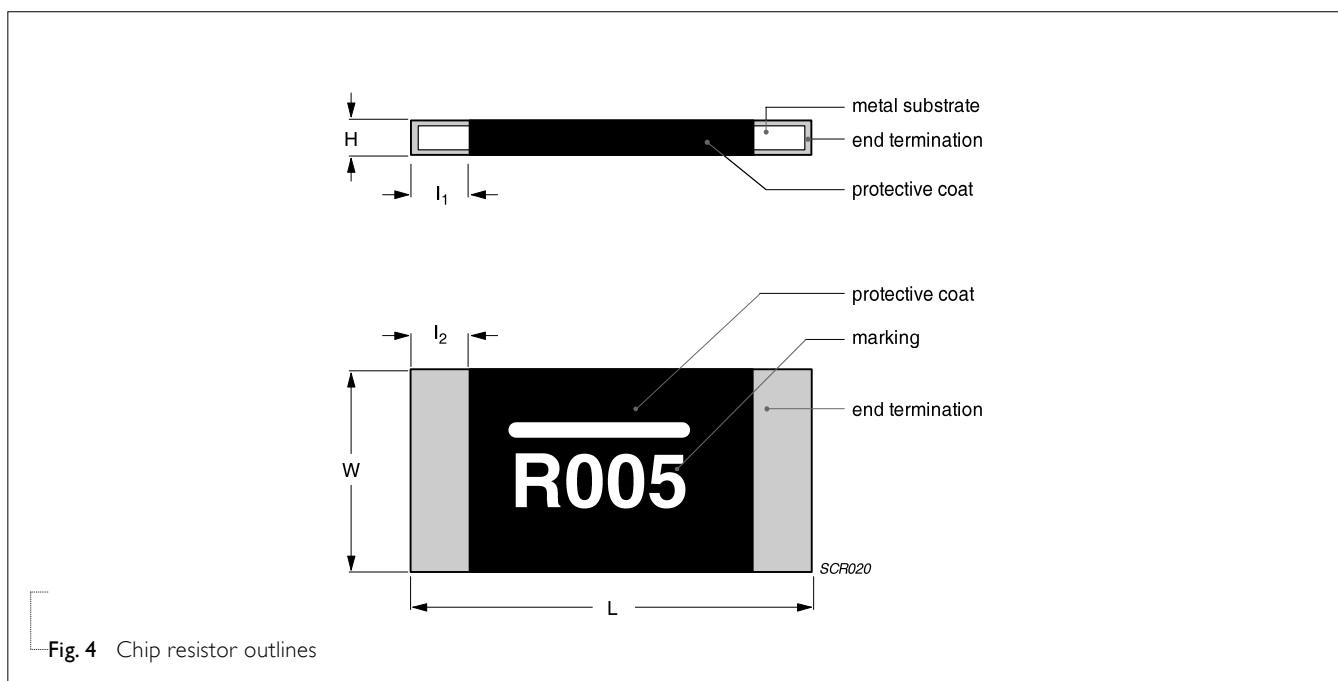
**Outlines**

**DIMENSION**

Table 1 For outlines, please refer to Fig. 4

TYPE	RESISTANCE RANGE	L (mm)	W (mm)	H (mm)	l <sub>1</sub> (mm)	l <sub>2</sub> (mm)
PA2512	$0.5\text{m}\Omega \leq R \leq 0.75\text{m}\Omega$	$6.35 \pm 0.25$	$3.18 \pm 0.25$	$0.63 \pm 0.25$	$2.72 \pm 0.25$	$2.72 \pm 0.25$
	$1\text{m}\Omega \leq R \leq 4\text{m}\Omega$	$6.35 \pm 0.25$	$3.18 \pm 0.25$	$0.63 \pm 0.25$	$2.21 \pm 0.25$	$2.21 \pm 0.25$
	$5\text{m}\Omega \leq R \leq 6\text{m}\Omega$	$6.35 \pm 0.25$	$3.18 \pm 0.25$	$0.63 \pm 0.25$	$1.19 \pm 0.25$	$1.19 \pm 0.25$
	$7\text{m}\Omega \leq R \leq 100\text{m}\Omega$	$6.35 \pm 0.25$	$3.18 \pm 0.25$	$0.63 \pm 0.25$	$0.76 \pm 0.25$	$0.76 \pm 0.25$

Note:

- For relevant physical dimensions, please refer to construction outlines.
- Please contact with sales offices, distributors and representatives in your region before ordering.

**ELECTRICAL CHARACTERISTICS**

Table 2

TYPE	SIZE	POWER RATING	TOLERANCE	RESISTANCE RANGE	TEMPERATURE COEFFICIENT OF RESISTANCE
PA	2512	1W	$\pm 0.5\%$	$0.5\text{m}\Omega \leq R \leq 100\text{m}\Omega$	$\pm 50\text{ppm}/^\circ\text{C}$
		2W	$\pm 1\%$		$\pm 75\text{ppm}/^\circ\text{C}$
		3W	$\pm 5\%$		$\pm 100\text{ppm}/^\circ\text{C}$

Note: Please contact with sales offices, distributors and representatives in your region before ordering.

**FUNCTIONAL DESCRIPTION****OPERATING TEMPERATURE RANGE**

PA2512 Range:  $-55^\circ\text{C}$  to  $+170^\circ\text{C}$

**POWER RATING**

Standard rated power at  $70^\circ\text{C}$ :

For detail power value, please refer to Table 2.

**RATED VOLTAGE**

The DC or AC (rms) continuous working voltage corresponding to the rated power is determined by the following formula:

$$V = \sqrt{P \times R}$$

Where

V = Continuous rated DC or AC (rms) working voltage (V)

P = Rated power (W)

R = Resistance value ( $\Omega$ )

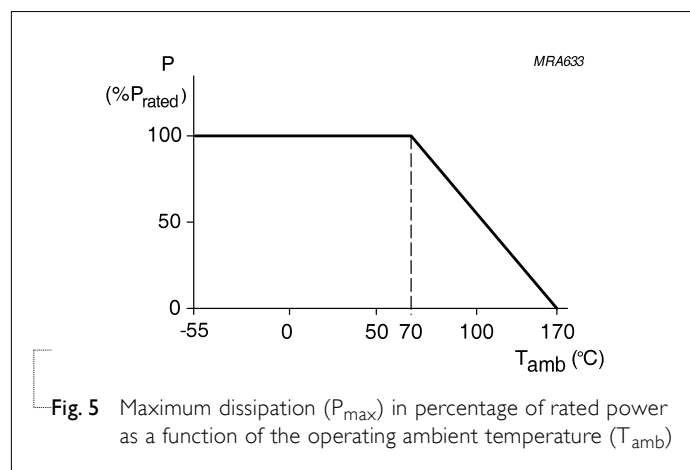

**PACKING STYLE AND PACKAGING QUANTITY**

Table 3 Packing style and packaging quantity

PACKING STYLE	REEL DIMENSION	PA2512
Embossed taping reel (K)	7" (178 mm)	4,000

**EMBOSSED TAPE**

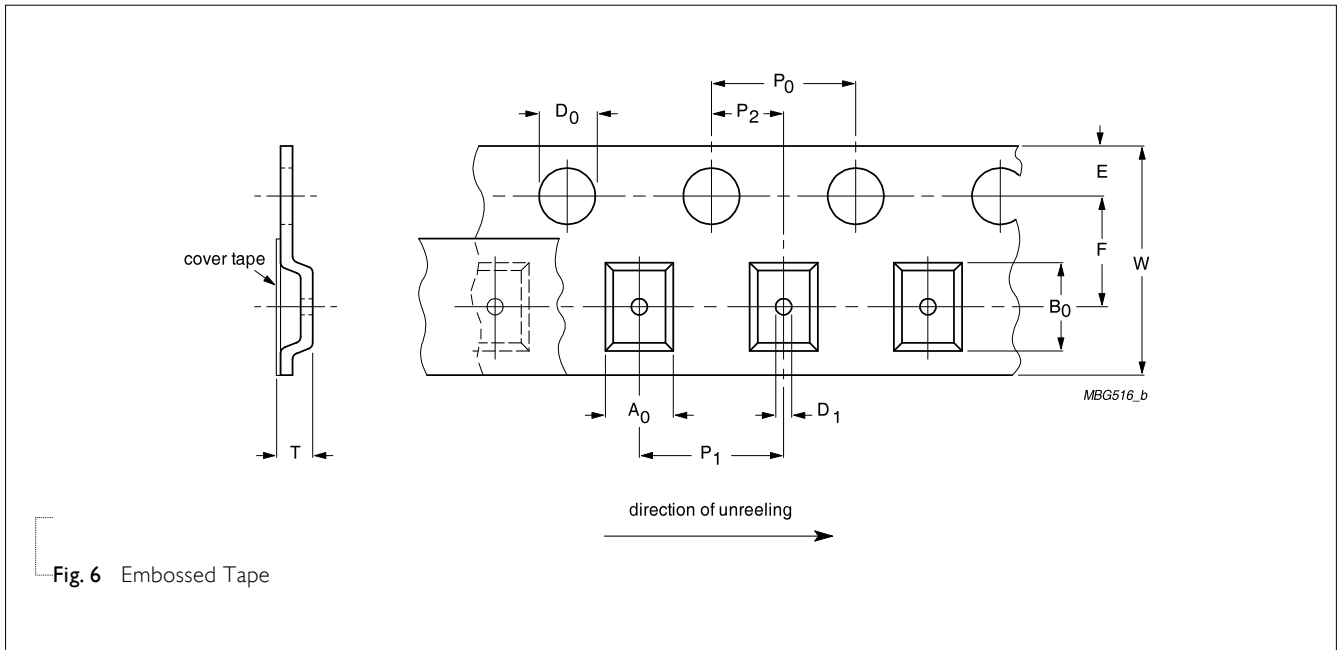

Fig. 6 Embossed Tape

Table 4 Dimensions of embossed tape for relevant chip resistors size

SIZE	SYMBOL											Unit: mm
	A <sub>0</sub>	B <sub>0</sub>	W	E	F	P <sub>0</sub>	P <sub>1</sub>	P <sub>2</sub>	ØD <sub>0</sub>	ØD <sub>1</sub>	T	
PA2512	3.40±0.15	6.70±0.15	12.00±0.30	1.75±0.10	5.50±0.10	4.00±0.10	4.00±0.10	2.00±0.10	1.55±0.05	1.50±0.10	0.80±0.15	

**REEL SPECIFICATION**

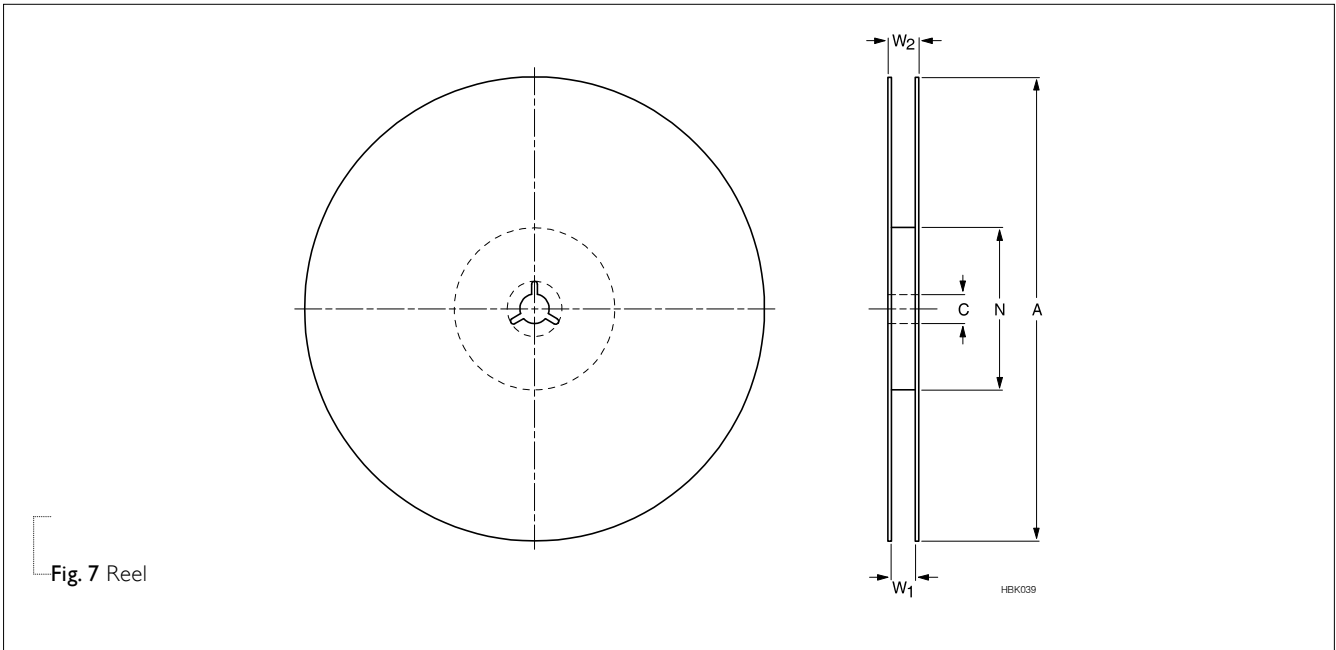
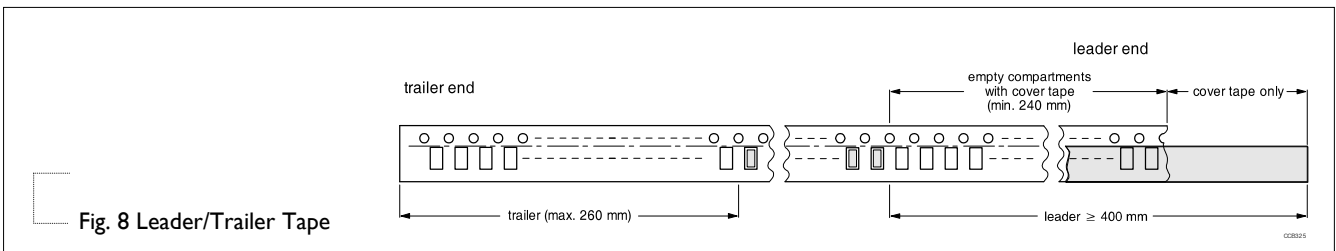

Table 5 Dimensions of reel specification for relevant chip resistors size

SIZE	QUANTITY PER REEL	REEL SIZE		SYMBOL				Unit: mm	
		8 mm TAPE WIDE	12 mm TAPE WIDE	A	N	C	D	W <sub>1</sub>	W <sub>2</sub> MAX.
PA2512	4000	--	7" (Ø178 mm)	178.0±1.0	60.0+1/-0	13.50±0.5	21.0±0.8	13.6±0.5	16.5±0.5

**LEADER/TRAILER TAPE SPECIFICATION**



**FOOTPRINT AND SOLDERING PROFILES**

For recommended soldering profiles, please refer to data sheet “Chip resistors mounting”.

**FOOTPRINT**

Table 6 Footprint dimensions

SIZE	RESISTANCE RANGE	A	B	C	D	Unit: mm
PA2512	$0.5\text{m}\Omega \leq R < 1\text{m}\Omega$	7.36	0.50	3.43	3.68	
	$1\text{m}\Omega \leq R \leq 4\text{m}\Omega$	7.37	1.27	3.05	3.68	
	$5\text{m}\Omega \leq R \leq 6\text{m}\Omega$	7.40	3.18	2.11	3.68	
	$7\text{m}\Omega \leq R \leq 100\text{m}\Omega$	7.36	4.06	1.65	3.68	

**TESTS AND REQUIREMENTS**

Table 8 Test condition, procedure and requirements

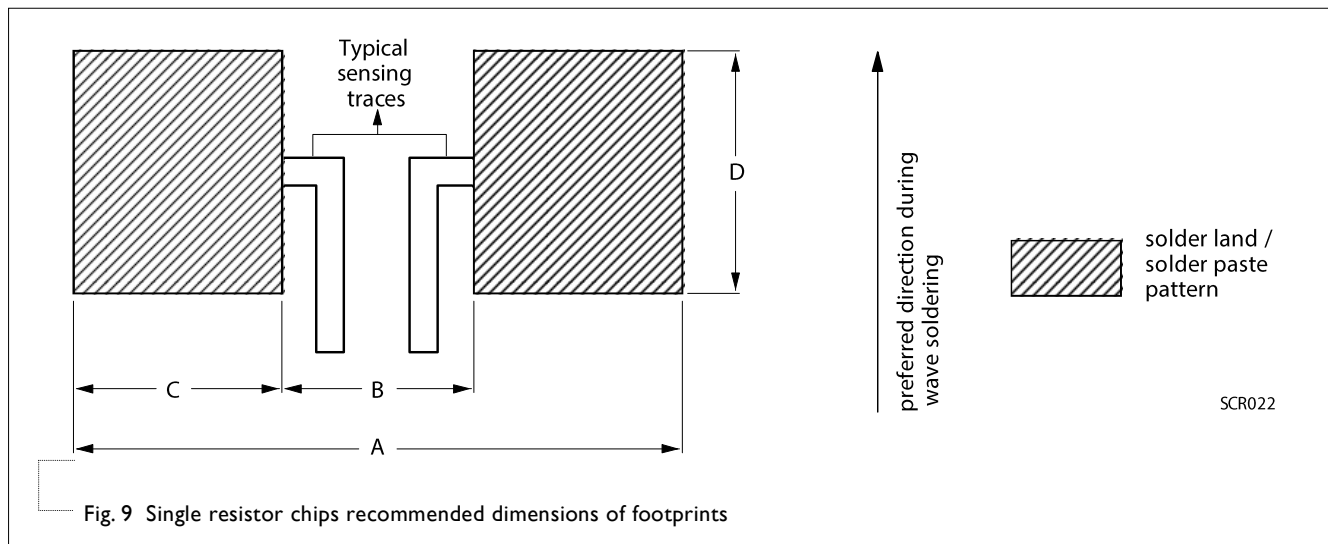
TEST	TEST METHOD	PROCEDURE	REQUIREMENT
Short time overload	IEC60115-1 4.13	5 times of rated power for 5 seconds at room temperature	$\pm(0.5\%+0.0005\Omega)$ No visible damage
High Temperature Exposure	MIL-STD-202-Method 108	1,000 hours at maximum operating temperature depending on specification, unpowered  No direct impingement of forced air to the parts Tolerances: $170\pm 3^{\circ}\text{C}$	$\pm(1.0\%+0.0005\Omega)$
Temperature Cycling	JESD22-A104C	1,000 cycles, $-55/+125^{\circ}\text{C}$ for 1 cycle per hour	$\pm(0.5\%+0.0005\Omega)$
Moisture Resistance	MIL-STD-202-Method 106	Each temperature / humidity cycle is defined at 8 hours (method 106F), 3 cycles / 24 hours for 10d with $25^{\circ}\text{C}$ / $65^{\circ}\text{C}$ 95% R.H, without steps 7a & 7b, unpowered	$\pm(0.5\%+0.0005\Omega)$
Biased Humidity	MIL-STD-202 Method 103	1,000 hours; $85^{\circ}\text{C}$ / 85% RH  10% of operating power	$\pm(0.5\%+0.0005\Omega)$
Operational Life/ Endurance	MIL-STD-202-Method 108	1,000 hours at $125\pm 3^{\circ}\text{C}$ , de-rated voltage applied for 1.5 hours on, 0.5 hour off, still-air required	$\pm(1.0\%+0.0005\Omega)$
		1,000 hours at $70\pm 2^{\circ}\text{C}$ applied RCWV  1.5 hours on, 0.5 hour off, still air required	$\pm(1.0\%+0.0005\Omega)$
Resistance to Solvents	MIL-STD-202 Method 215	Immerse in isopropyl alcohol for 5 min with ultrasonic at room temperature	No Visible damage
Mechanical Shock	MIL-STD-202 Method 213	Three shocks in each direction shall be applied along the three mutually perpendicular axes of the test specimen.  Peak value: 100 g's  Duration: 6 ms  Velocity change: 12.3 ft/s  Waveform: Half sine	$\pm(0.5\%+0.0005\Omega)$
Vibration	MIL-STD-202 Method 204	5 g's for 20 min., 12 cycles each of 3 orientations  Test from 10-2000 Hz.	$\pm(0.5\%+0.0005\Omega)$
Resistance to Soldering Heat	MIL-STD-202-method 210	Condition B, no pre-heat of samples  Leadfree solder, $260^{\circ}\text{C}$ , 10 seconds immersion time  Procedure 2 for SMD: devices fluxed and cleaned with isopropanol	$\pm(0.5\%+0.0005\Omega)$ No visible damage
Thermal Shock	MIL-STD-202 Method 107	$-55/+125^{\circ}\text{C}$ , Number of cycles is 300.  Devices mounted.  Maximum transfer time is 20 seconds.  Dwell time is 15 minutes. Air -Air	$\pm(0.5\%+0.0005\Omega)$ No visible damage

TEST	TEST METHOD	PROCEDURE	REQUIREMENT
Electrostatic Discharge	AEC-Q200-002	Human Body Model, 1 pos + 1 neg. Discharges 2512=2KV	$\pm(1.0\%+0.0005\Omega)$ No visible damage
Solderability - Wetting	J-STD-002B test B	(a) Method B, aging 4 hours at 155°C dry heat, dipping at 235±3°C for 5±0.5 seconds. (b) Method B, steam aging 8 hours, dipping at 215±3°C for 5±0.5 seconds. (c) Method D, steam aging 8 hours, dipping at 260±3 °C for 7±0.5 seconds.	Well tinned (>95% covered) No visible damage
Flammability	UL94	Try to inflame a specimen by a needle flame	No ignition of specimen; V-0
Board Flex / Bending	AEC-Q200-005	Chips mounted on a 90mm glass epoxy resin PCB (FR4), Bending for 2512=2 mm Holding time: Min.60 seconds	$\pm(1.0\%+0.0005\Omega)$
Terminal Strength (SMD)	AEC-Q200-006	Applied a 17.7N (1.8Kg) for 60±1 seconds.	$\pm(1.0\%+0.0005\Omega)$ No visible damage
Flame Retardance	AEC-Q200-001	Apply voltage from 9V to 32V to increase the surface temp to 350°C	No flame, no explosion
Temperature Coefficient of Resistance (T.C.R.)	MIL-STD-202 Method 304	At +25/+150°C Formula: $T.C.R.= \frac{R_2 - R_1}{R_1(t_2 - t_1)} \times 10^6(\text{ppm}/^\circ\text{C})$ Where t1=+25°C or specified room temperature t2=+150°C test temperature R1=resistance at reference temperature in ohms R2=resistance at test temperature in ohms	Refer to table 2
Flower-of-Sulfur (FOS)	Modified ASTM B809-95	Sulfur 105°C, 750 hours, unpowered.	$\pm(1.0\%+0.0005\Omega)$

REVISION HISTORY

REVISION	DATE	CHANGE NOTIFICATION	DESCRIPTION
Version 10	Jan. 31, 2018	-	- Extend 0.5% Tolerance
Version 9	Nov. 21, 2017	-	- Extend resistor value for 3W
Version 8	Oct. 23, 2017	-	- Update footprint dimensions
Version 7	Jul. 24, 2017	-	- Add part number coding details for the relationship between taping reel and rated power
Version 6	Apr. 19, 2017	-	- Extend resistor value
Version 5	Nov. 30, 2016	-	- Extend resistor value
Version 4	Oct. 27, 2016	-	- Modify the error of test procedure
Version 3	Mar. 31, 2016	-	- Update TCR
Version 2	Dec. 31, 2015	-	- Extend resistor value
Version 1	Dec. 18, 2015	-	- Update tests and requirements

*“Yageo reserves all the rights for revising the content of this datasheet without further notification, as long as the products itself are unchanged. Any product change will be announced by PCN.”*

---

**Chip Resistor Surface Mount**LEGAL DISCLAIMER

YAGEO, its distributors and agents (collectively, "YAGEO"), hereby disclaims any and all liabilities for any errors, inaccuracies or incompleteness contained in any product related information, including but not limited to product specifications, datasheets, pictures and/or graphics. YAGEO may make changes, modifications and/or improvements to product related information at any time and without notice.

YAGEO makes no representation, warranty, and/or guarantee about the fitness of its products for any particular purpose or the continuing production of any of its products. To the maximum extent permitted by law, YAGEO disclaims (i) any and all liability arising out of the application or use of any YAGEO product, (ii) any and all liability, including without limitation special, consequential or incidental damages, and (iii) any and all implied warranties, including warranties of fitness for a particular purpose, non-infringement and merchantability.

YAGEO products are designed for general purpose applications under normal operation and usage conditions. Please contact YAGEO for the applications listed below which require especially high reliability for the prevention of defects which might directly cause damage to the third party's life, body or property: Aerospace equipment (artificial satellite, rocket, etc.), Atomic energy-related equipment, Aviation equipment, Disaster prevention equipment, crime prevention equipment, Electric heating apparatus, burning equipment, Highly public information network equipment, data-processing equipment, Medical devices, Military equipment, Power generation control equipment, Safety equipment, Traffic signal equipment, Transportation equipment and Undersea equipment, or for any other application or use in which the failure of YAGEO products could result in personal injury or death, or serious property damage. Particularly **YAGEO Corporation and its affiliates do not recommend the use of commercial or automotive grade products for high reliability applications or manned space flight.**

Information provided here is intended to indicate product specifications only. YAGEO reserves all the rights for revising this content without further notification, as long as products are unchanged. Any product change will be announced by PCN.

## OUR CERTIFICATE

DiGi provide top-quality products and perfect service for customer worldwide through standardization, technological innovation and continuous improvement. DiGi through third-party certification, we stricly control the quality of products and services. Welcome your RFQ to

Email: [Info@DiGi-Electronics.com](mailto:Info@DiGi-Electronics.com)



Tel: +00 852-30501935

RFQ Email: [Info@DiGi-Electronics.com](mailto:Info@DiGi-Electronics.com)

DiGi is a global authorized distributor of electronic components.