

YC164-JR-072K2L Datasheet

www.digi-electronics.com

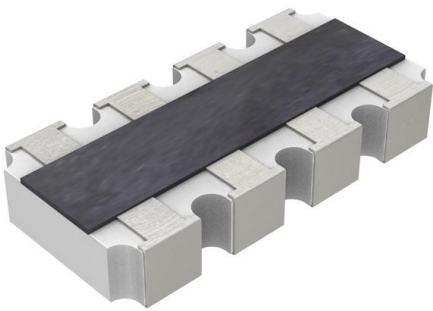

<https://www.DiGi-Electronics.com>

DiGi Electronics Part Number	YC164-JR-072K2L-DG
Manufacturer	YAGEO
Manufacturer Product Number	YC164-JR-072K2L
Description	RES ARRAY 4 RES 2.2K OHM 1206
Detailed Description	2.2k Ohm $\pm 5\%$ 62.5mW Power Per Element Isolated 4 Resistor Network/Array $\pm 200\text{ppm}/^\circ\text{C}$ 1206 (3216 Metric), Convex, Long Side Terminals

This model YC164-JR-072K2L is available at DiGi Electronics.

DiGi Electronics offers a global database of semiconductor and electronic component datasheets.

We welcome your inquiries regarding pricing, lead time, or other product-related questions.

 [Request a Quote](#)

 [Datasheet Search](#)



Tel: +00 852-30501935

RFQ Email: Info@DiGi-Electronics.com

DiGi is a global authorized distributor of electronic components.

Purchase and inquiry

Manufacturer Product Number:

YC164-JR-072K2L

Series:

YC164

Circuit Type:

Isolated

Tolerance:

±5%

Resistor Matching Ratio:

-

Number of Pins:

8

Temperature Coefficient:

±200ppm/°C

Grade:

Automotive

Applications:

DDRAM, SDRAM

Package / Case:

1206 (3216 Metric), Convex, Long Side Terminals

Size / Dimension:

0.126" L x 0.063" W (3.20mm x 1.60mm)

Base Product Number:

YC164-JR

Manufacturer:

YAGEO

Product Status:

Active

Resistance (Ohms):

2.2k

Number of Resistors:

4

Resistor-Ratio-Drift:

-

Power Per Element:

62.5mW

Operating Temperature:

-55°C ~ 155°C

Qualification:

AEC-Q200

Mounting Type:

Surface Mount

Supplier Device Package:

-

Height - Seated (Max):

0.028" (0.70mm)

Environmental & Export classification

RoHS Status:

ROHS3 Compliant

REACH Status:

REACH Unaffected

HTSUS:

8533.21.0020

Moisture Sensitivity Level (MSL):

1 (Unlimited)

ECCN:

EAR99

DATA SHEET

ARRAY CHIP RESISTORS

YC/TC

5%, 1%

sizes

YC: 102/104/122/124/164/248/324/158T/358L/358T

TC: 122/124/164

RoHS compliant



MARKING

YC102

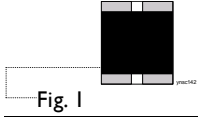

No marking

YC122

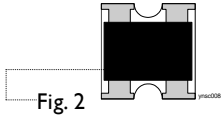

No marking

YC104

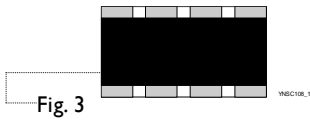

No marking

YC124 /164 / 324

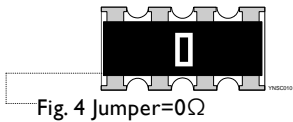

I-Digit marking

Fig. 4 Jumper=0Ω

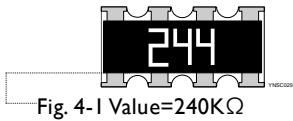

E-24 series: 3 digits, 5%
First two digits for significant figure and 3rd digit for number of zeros

Fig. 4-I Value=240KΩ

YC248

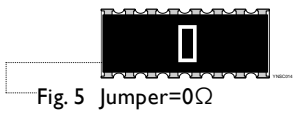

I-Digit marking

Fig. 5 Jumper=0Ω

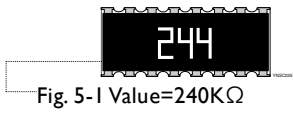

E-24 series: 3 digits, 5%
First two digits for significant figure and 3rd digit for number of zeros

Fig. 5-I Value=240KΩ

YC158T/358L/358T

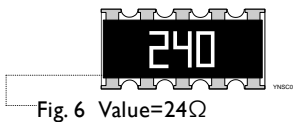

Fig. 6 Value=24Ω

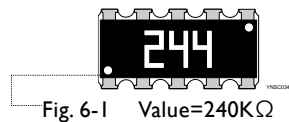
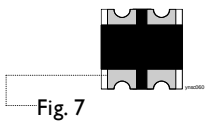

Fig. 6-I Value=240KΩ

E-24 series: 3 digits
First two digits for significant figure and 3rd digit for number of zeros

TC122



No marking

Fig. 7

TC124

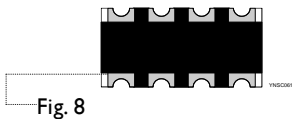

No marking

Fig. 8

TCI64

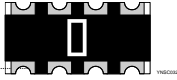

I-Digit marking

Fig. 9 Jumper=0Ω



E-24 series: 3 digits, 5%
First two digits for significant figure and 3rd digit for number of zeros

Fig. 9-I Value=240KΩ

For further marking information, please refer to data sheet “Chip resistors marking”.

CONSTRUCTION

The resistor is constructed on top of a high-grade ceramic body. Internal metal electrodes are added on each end to make the contacts to the thick film resistive element. The composition of the resistive element is a noble metal imbedded into a glass and covered by a second glass to prevent environment influences. The resistor is laser trimmed to the rated resistance value. The resistor is covered with a protective epoxy coat, finally the two external terminations (matte tin on Ni-barrier) are added as shown in Fig.10.

OUTLINES

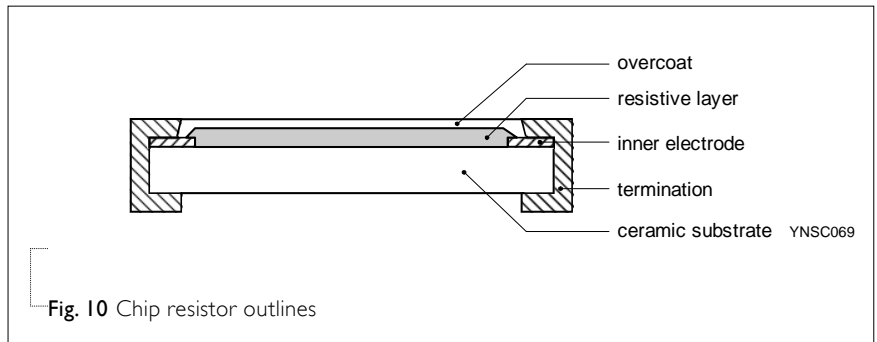
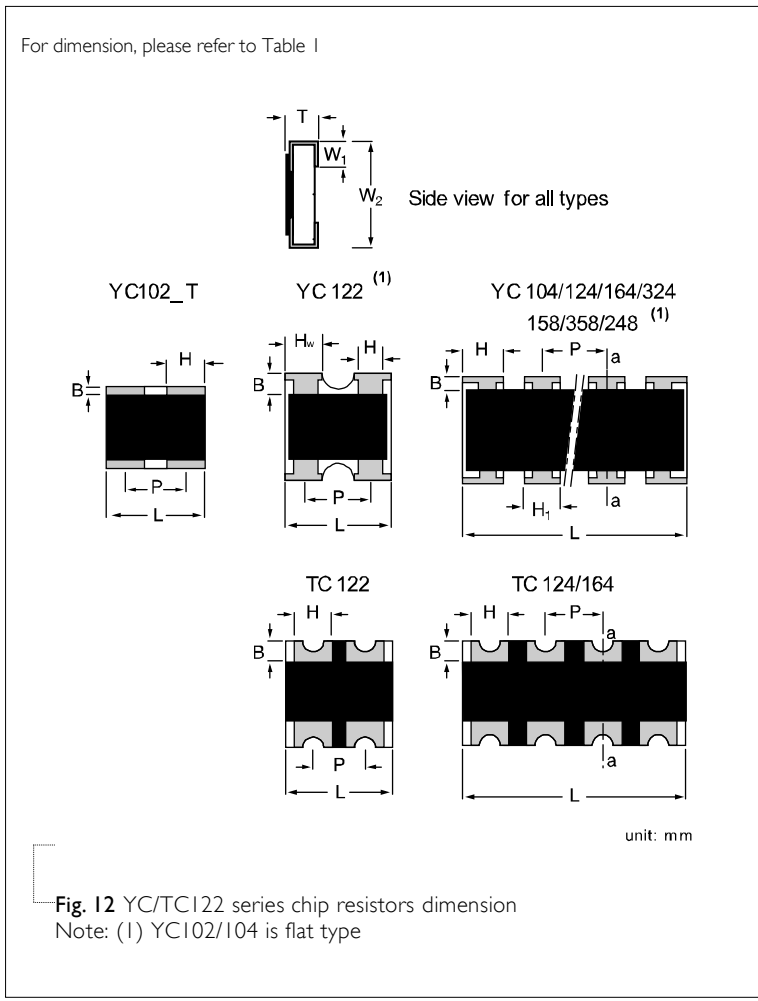
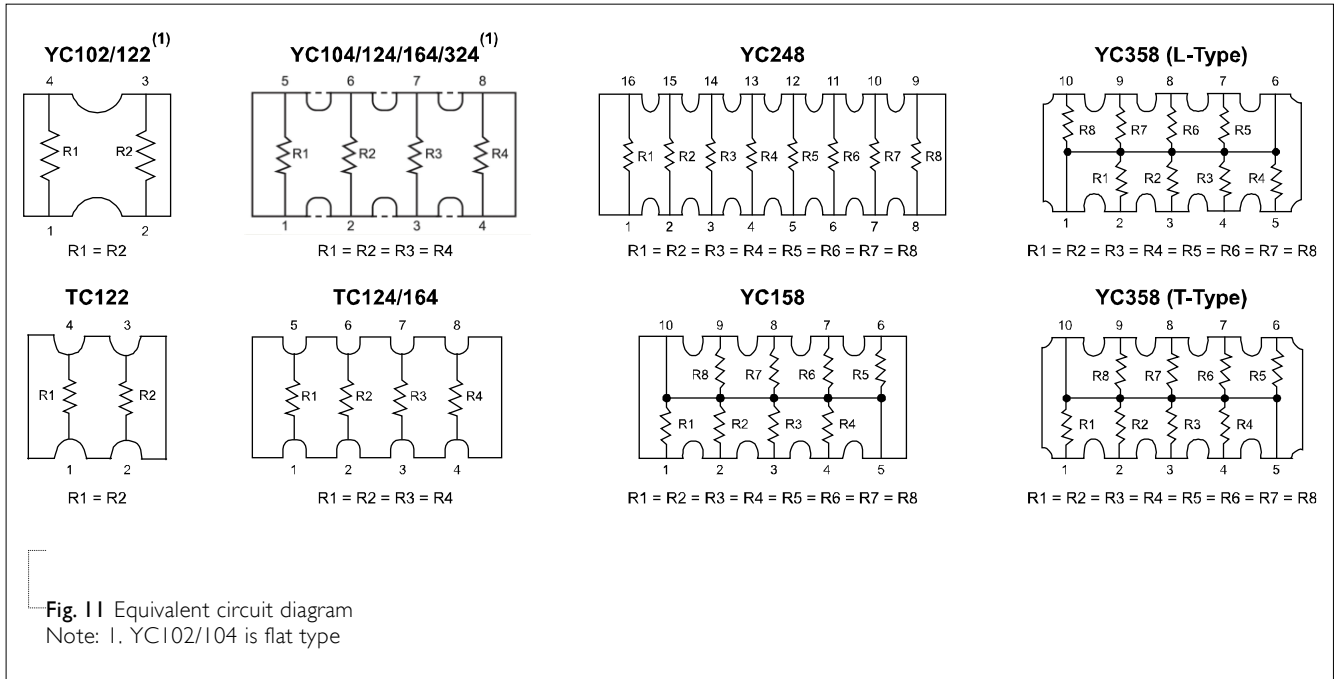

Fig. 10 Chip resistor outlines

SCHEMATIC



DIMENSIONS

Table I

TYPE	H / H _i / H _w	B	P	L	T	W1	W2
YC102	H: 0.25±0.10	0.15±0.10	0.55±0.10	0.80±0.10	0.35±0.10	0.15±0.10	0.60±0.10
YC104	H: 0.20±0.10	0.15±0.05	0.40±0.10	1.40±0.10	0.35±0.10	0.15±0.10	0.60±0.10
YC122	H: 0.210.10 / -0.05 H _w : 0.35±0.10	0.20±0.10	0.67±0.05	1.00±0.10	0.30±0.10	0.25±0.10	1.00±0.10
YC124	H: 0.40±0.15 H _i : 0.30±0.05	0.20±0.15	0.50±0.05	2.00±0.10	0.45±0.10	0.30±0.15	1.00±0.10
YC164	H: 0.65±0.05 H _i : 0.50±0.15	0.30±0.15	0.80±0.05	3.20±0.15	0.60±0.10	0.30±0.15	1.60±0.15
YC248	H: 0.45±0.05 H _i : 0.30±0.05	0.30±0.15	0.50±0.05	4.00±0.20	0.45±0.10	0.40±0.15	1.60±0.15
YC324	H: 1.10±0.15 H _i : 0.90±0.15	0.50±0.20	1.27±0.05	5.08±0.20	0.60±0.10	0.50±0.15	3.20±0.20
TC122	H: 0.30±0.05	0.25±0.15	0.50±0.05	1.00±0.10	0.30±0.10	0.25±0.15	1.00±0.10
TC124	H: 0.30±0.10	0.20±0.10	0.50±0.05	2.00±0.10	0.40±0.10	0.25±0.10	1.00±0.10
TC164	H: 0.50±0.15	0.30±0.15	0.80±0.05	3.20±0.15	0.60±0.10	0.30±0.15	1.60±0.15
YC158T	H: 0.45±0.05 H _i : 0.32±0.05	0.30±0.15	0.64±0.05	3.20±0.20	0.60±0.10	0.35±0.15	1.60±0.15
YC358L YC358T	H: 1.10±0.15 H _i : 0.90±0.15	0.50±0.15	1.27±0.05	6.40±0.20	0.60±0.10	0.50±0.15	3.20±0.20

ELECTRICAL CHARACTERISTICS

Table 2

TYPE	POWER P ₇₀	OPERATING TEMP. RANGE	MWV	RCOV	DWV	RESISTANCE RANGE & TOLERANCE	T. C. R.	Jumper criteria (unit: A)
YC102	1/32W	-55°C to +125°C	15V	30V	30V	E24 ±5% 10Ω ≤ R ≤ 1MΩ E24/E96 ±1% 10Ω ≤ R ≤ 1MΩ Jumper < 0.05Ω	±200 ppm/°C	Rated current 0.5 Max. current 1.0
YC104	1/32W	-55°C to +125°C	12.5V	25V	25V	E24 ±5% 10Ω ≤ R ≤ 1MΩ E24/E96 ±1% 10Ω ≤ R ≤ 1MΩ Jumper < 0.05Ω		Rated current 0.5 Max. current 1.0
YC122	1/16W	-55°C to +155°C	50V	100V	100V	E24 ±5% 1Ω ≤ R ≤ 1MΩ E24/E96 ±1% 1Ω ≤ R ≤ 1MΩ Jumper < 0.05Ω	1Ω ≤ R ≤ 10Ω ±250 ppm/°C	Rated current 0.5 Max. current 1.0
YC124	1/16W	-55°C to +155°C	25V	50V	100V	E24 ±5% 1Ω ≤ R ≤ 1MΩ E24/E96 ±1% 1Ω ≤ R ≤ 1MΩ Jumper < 0.05Ω	10Ω < R ≤ 1MΩ ±200 ppm/°C	Rated current 1.0 Max. current 2.0
YC164	1/16W	-55°C to +155°C	50V	100V	100V	E24 ±5% 1Ω ≤ R ≤ 1MΩ E24/E96 ±1% 1Ω ≤ R ≤ 1MΩ Jumper < 0.05Ω		Rated current 1.0 Max. current 2.0
YC248	1/16W	-55°C to +155°C	50V	100V	100V	E24 ±5% 10Ω ≤ R ≤ 1MΩ E24/E96 ±1% 10Ω ≤ R ≤ 1MΩ Jumper < 0.05Ω		Rated current 2.0 Max. current 10.0
YC324	1/8W	-55°C to +155°C	200V	500V	500V	E24 ±5% 10Ω ≤ R ≤ 1MΩ E24/E96 ±1% 10Ω ≤ R ≤ 1MΩ		--- ---
TC122	1/16W	-55°C to +125°C	50V	100V	100V	E24 ±5% 10Ω ≤ R ≤ 1MΩ E24/E96 ±1% 10Ω ≤ R ≤ 1MΩ Jumper < 0.05Ω	±200 ppm/°C	Rated current 1.0 Max. current 1.5
TC124	1/16W	-55°C to +125°C	50V	100V	100V	E24 ±5% 10Ω ≤ R ≤ 1MΩ E24/E96 ±1% 10Ω ≤ R ≤ 1MΩ Jumper < 0.05Ω		Rated current 1.0 Max. current 1.5
TC164	1/16W	-55°C to +155°C	50V	100V	100V	E24 ±5% 10Ω ≤ R ≤ 1MΩ E24/E96 ±1% 10Ω ≤ R ≤ 1MΩ Jumper < 0.05Ω		Rated current 1.0 Max. current 2.0
YC158T	1/16W	-55°C to +155°C	25V	50V	50V	E24 ±5% 10Ω ≤ R ≤ 100KΩ		--- ---
YC358L YC358T	1/16W	-55°C to +155°C	50V	100V	100V	E24 ±5% 10Ω ≤ R ≤ 330KΩ		--- ---

FOOTPRINT AND SOLDERING PROFILES

For recommended footprint and soldering profiles, please refer to data sheet “Chip resistors mounting”.

PACKING STYLE AND PACKAGING QUANTITY

Table 3 Packing style and packaging quantity

PACKING STYLE	PACKING STYLE	YC102/ 104	YC/TC 122	YC/TC 124	YC/TC 164	YC248	YC324	YC158T	YC358L YC358T
Paper taping reel (R)	7" (178mm)	10,000	10,000	10,000	5,000	5,000	---	5,000	---
	13" (254mm)	50,000	50,000	40,000	20,000	---	---	20,000	---
Embossed taping reel (K)	7" (178mm)	---	---	---	---	4,000	4,000	---	4,000

NOTE

1. For tape and reel specification/dimensions, please refer to data sheet “Chip resistors packing”.



FUNCTIONAL DESCRIPTION

OPERATING TEMPERATURE RANGE

YC102/104, TC122/124 Range:

-55°C to +125°C (Fig.13)

YC122/124/164/248/324/158T/358L/358T, TC164

Range:

-55°C to +155°C (Fig.14)

POWER RATING

Each type rated power at 70°C

YC102/104 = 1/32 W

YC122/124/164/248/158T/358L/358T = 1/16 W

YC324 = 1/8 W

TC122/124/164 = 1/16 W

RATED VOLTAGE

The DC or AC (rms) continuous working voltage corresponding to the rated power is determined by the following formula:

$$V = \sqrt{P \times R}$$

or max. working voltage whichever is less

Where

V=Continuous rated DC or AC (rms) working voltage (V)

P=Rated power (W)

R=Resistance value (Ω)

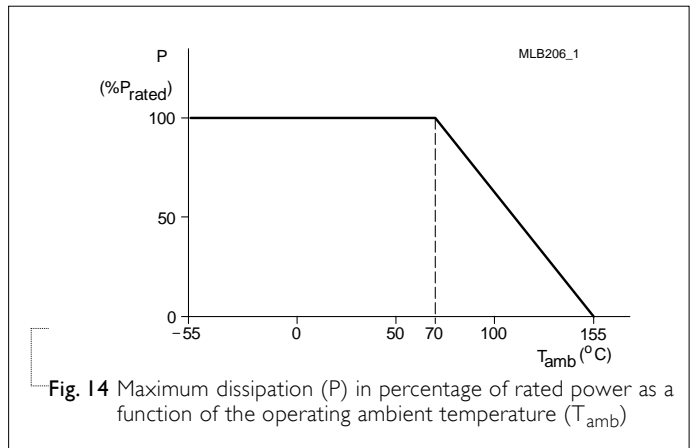
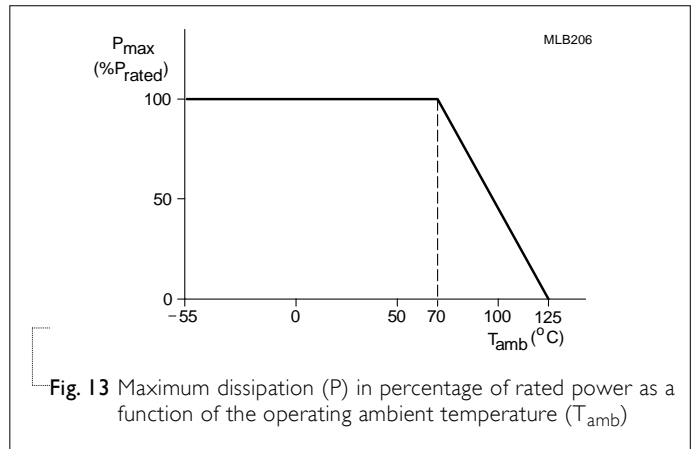

TESTS AND REQUIREMENTS

Table 4 Test condition, procedure and requirements

TEST	TEST METHOD	PROCEDURE	REQUIREMENTS
Life/ Operational Life/ Endurance	MIL-STD-202-method 108 IEC 60115-1 7.1	1,000 hours at 70±5 °C applied RCWV 1.5 hours on, 0.5 hour off, still air required	±(2%+0.05 Ω) <100 mΩ for Jumper
High Temperature Exposure/ Endurance at Upper Category Temperature	MIL-STD-202-method 108	1,000 hours at maximum operating temperature depending on specification, unpowered	±(1%+0.05 Ω) <50 mΩ for Jumper
Moisture Resistance	MIL-STD-202-method 106 IEC 60115-1 4.24.2	Each temperature / humidity cycle is defined at 8 hours, 3 cycles / 24 hours for 10d with 25 °C / 65 °C 95% R.H, without steps 7a & 7b, unpowered Parts mounted on test-boards, without condensation on parts Measurement at 24±2 hours after test conclusion	±(2%+0.05 Ω) <100 mΩ for Jumper
Thermal Shock	MIL-STD-202-method 107	-55/+125 °C Note: Number of cycles required is 300. Devices mounted Maximum transfer time is 20 seconds. Dwell time is 15 minutes. Air – Air	±(1%+0.05 Ω) <50 mΩ for Jumper
Short Time Overload	IEC60115-1 8.1	2.5 times RCWV or maximum overload voltage whichever is less for 5 sec at room temperature	±(2%+0.05 Ω) <50 mΩ for Jumper No visible damage
Board Flex/ Bending	IEC60115-1 9.8	Device mounted on PCB test board as described, only 1 board bending required 3 mm bending Bending time: 60±5 seconds Ohmic value checked during bending	±(1%+0.05 Ω) <50 mΩ for Jumper No visible damage

TEST	TEST METHOD	PROCEDURE	REQUIREMENTS
Solderability - Wetting	J-STD-002 test	Electrical Test not required Magnification 50X SMD conditions: 1 st step: aging 4 hours at 155 °C dry heat 2 nd step: method B1, leadfree solder bath at 245±3 °C Dipping time: 3±0.5 seconds	Well tinned (≥95% covered) No visible damage
- Leaching	J-STD-002 test	Leadfree solder, 260 °C, 30 seconds immersion time	No visible damage
- Resistance to Soldering Heat	MIL-STD-202-method 210	Condition B, no pre-heat of samples Leadfree solder, 260 °C, 10 seconds immersion time Procedure 2 for SMD: devices fluxed and cleaned with isopropanol	±(1%+0.05 Ω) <50 mΩ for Jumper No visible damage
Biased Humidity	AEC-Q200 Test 7 MIL-STD-202-Method 103	1,000 hours; 85 °C / 85% RH 10% of operating power Measurement at 24± 4 hours after test conclusion.	± (5.0%+0.05 Ω)

REVISION HISTORY

REVISION	DATE	CHANGE NOTIFICATION	DESCRIPTION
Version 10	Dec. 26, 2024	-	- Remove YC162
Version 9	Feb.19, 2019	-	- Update H dimension for YC124
Version 8	Dec. 24, 2018	-	- Update AEC-Q200 qualified
Version 7	Aug. 22, 2017	-	- Correct the typo for YC158T/358L/358T, Marking, "240" is 24ohm
Version 6	Jun. 1, 2017	-	- Update ordering information for networks YC158T/YC358L/YC358T
Version 5	Feb. 14, 2017	-	- Update YC158 and 358 part number to YC158T , YC358L and YC358T
Version 4	Dec. 22, 2016	-	- Delete YC102 default code L type
Version 3	Apr. 29, 2016	-	- Update YC series and TC164 dimension
Version 2	Dec. 11, 2015	-	- Update Operating Temperature
Version 1	Feb. 04, 2015	-	- Update YC102 to flat type
Version 0	Nov. 14, 2014	-	- First issue of this specification

LEGAL DISCLAIMER

YAGEO, its distributors and agents (collectively, "YAGEO"), hereby disclaims any and all liabilities for any errors, inaccuracies or incompleteness contained in any product related information, including but not limited to product specifications, datasheets, pictures and/or graphics. YAGEO may make changes, modifications and/or improvements to product related information at any time and without notice.

YAGEO makes no representation, warranty, and/or guarantee about the fitness of its products for any particular purpose or the continuing production of any of its products. To the maximum extent permitted by law, YAGEO disclaims (i) any and all liability arising out of the application or use of any YAGEO product, (ii) any and all liability, including without limitation special, consequential or incidental damages, and (iii) any and all implied warranties, including warranties of fitness for a particular purpose, non-infringement and merchantability.

YAGEO products are designed for general purpose applications under normal operation and usage conditions. Please contact YAGEO for the applications listed below which require especially high reliability for the prevention of defects which might directly cause damage to the third party's life, body or property: Aerospace equipment (artificial satellite, rocket, etc.), Atomic energy-related equipment, Aviation equipment, Disaster prevention equipment, crime prevention equipment, Electric heating apparatus, burning equipment, Highly public information network equipment, data-processing equipment, Medical devices, Military equipment, Power generation control equipment, Safety equipment, Traffic signal equipment, Transportation equipment and Undersea equipment, or for any other application or use in which the failure of YAGEO products could result in personal injury or death, or serious property damage. Particularly **YAGEO Corporation and its affiliates do not recommend the use of commercial or automotive grade products for high reliability applications or manned space flight.**

Information provided here is intended to indicate product specifications only. YAGEO reserves all the rights for revising this content without further notification, as long as products are unchanged. Any product change will be announced by PCN.

OUR CERTIFICATE

DiGi provide top-quality products and perfect service for customer worldwide through standardization, technological innovation and continuous improvement. DiGi through third-party certification, we stricly control the quality of products and services. Welcome your RFQ to

Email: Info@DiGi-Electronics.com



Tel: +00 852-30501935

RFQ Email: Info@DiGi-Electronics.com

DiGi is a global authorized distributor of electronic components.