

AL3066S16-13 Datasheet

www.digi-electronics.com

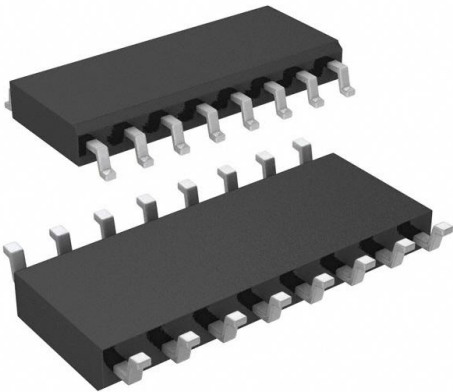

<https://www.DiGi-Electronics.com>

DiGi Electronics Part Number	AL3066S16-13-DG
Manufacturer	Diodes Incorporated
Manufacturer Product Number	AL3066S16-13
Description	IC LED DRVR CTRLR PWM 250MA 16SO
Detailed Description	LED Driver IC 4 Output DC DC Controller Step-Up (Boost) Analog, PWM Dimming 250mA 16-SO



Tel: +00 852-30501935

RFQ Email: Info@DiGi-Electronics.com

DiGi is a global authorized distributor of electronic components.

Purchase and inquiry

Manufacturer Product Number:

AL3066S16-13

Series:

-

Type:

DC DC Controller

Internal Switch(s):

No

Voltage - Supply (Min):

4.5V

Voltage - Output:

100V

Frequency:

1MHz

Applications:

Backlight

Mounting Type:

Surface Mount

Supplier Device Package:

16-SO

Manufacturer:

Diodes Incorporated

Product Status:

Active

Topology:

Step-Up (Boost)

Number of Outputs:

4

Voltage - Supply (Max):

33V

Current - Output / Channel:

250mA

Dimming:

Analog, PWM

Operating Temperature:

-40°C ~ 85°C (TA)

Package / Case:

16-SOIC (0.154", 3.90mm Width)

Base Product Number:

AL3066

Environmental & Export classification

RoHS Status:

ROHS3 Compliant

REACH Status:

REACH Unaffected

HTSUS:

8542.39.0001

Moisture Sensitivity Level (MSL):

1 (Unlimited)

ECCN:

EAR99

Description

The AL3066 is a high efficiency 4-channel boost controller for WLED backlight applications. It operates over a wide input voltage ranged from 4.5V to 33V.

The current of the 4 channels is simply programmed from 20mA to 400mA with an external resistor. The current match between any channel is $\pm 1.5\%$ (typical). Its operating frequency can be adjusted from 0.1MHz to 1MHz.

The AL3066 can support two dimming modes: direct PWM dimming, PWM to analog dimming.

Robust protection features include cycle by cycle current limit, soft-start, UVLO, programmable OVP, OTP, open/short LED protection, Schottky Diode Short and Open Protection, Inductor Short-Circuit Protection and V_{OUT} Short protection.

The IC is available in SO-16 package.

Pin Assignments

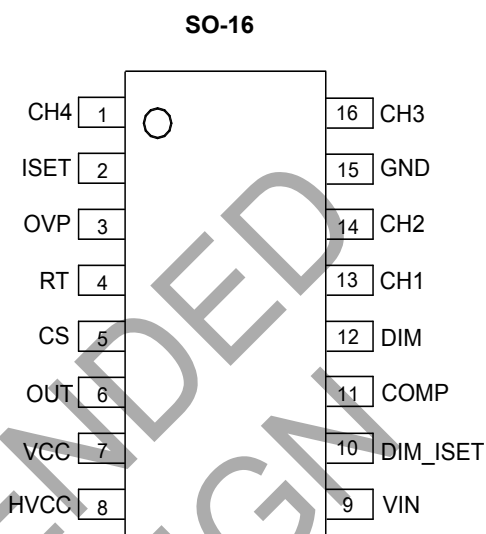

Features

- Input Voltage Range: 4.5V to 33V
- Drivers Up to 4 Strings in Parallel, 250mA Per String, 400mA Pulse Current
- $\pm 3\%$ Current Precision
- Low Ripple for Low BOM Cost
- 4kV HBM ESD Class
- High Voltage Pins CS and OVP for Safety Test
- Support Direct PWM Dimming, PWM to Analog Dimming
- Minimum PWM Dimming Duty Cycle can be 1/10,000 at 100Hz Dimming Frequency
- LED Open/Short Protection
- Schottky Diode/Inductor Short-Circuit Protection
- Built-in OCP, OVP, OTP, UVLO, V_{OUT} Short/Schottky Diode Open Protection
- **Totally Lead-Free & Fully RoHS Compliant (Notes 1 & 2)**
- **Halogen and Antimony Free. "Green" Device (Note 3)**

Applications

- LCD Monitor
- LCD Display Module
- LCD TV

- Notes:
1. No purposely added lead. Fully EU Directive 2002/95/EC (RoHS) & 2011/65/EU (RoHS 2) compliant.
 2. See http://www.diodes.com/quality/lead_free.html for more information about Diodes Incorporated's definitions of Halogen- and Antimony-free, "Green" and Lead-free.
 3. Halogen- and Antimony-free "Green" products are defined as those which contain <900ppm bromine, <900ppm chlorine (<1500ppm total Br + Cl) and <1000ppm antimony compounds.

Typical Applications Circuit

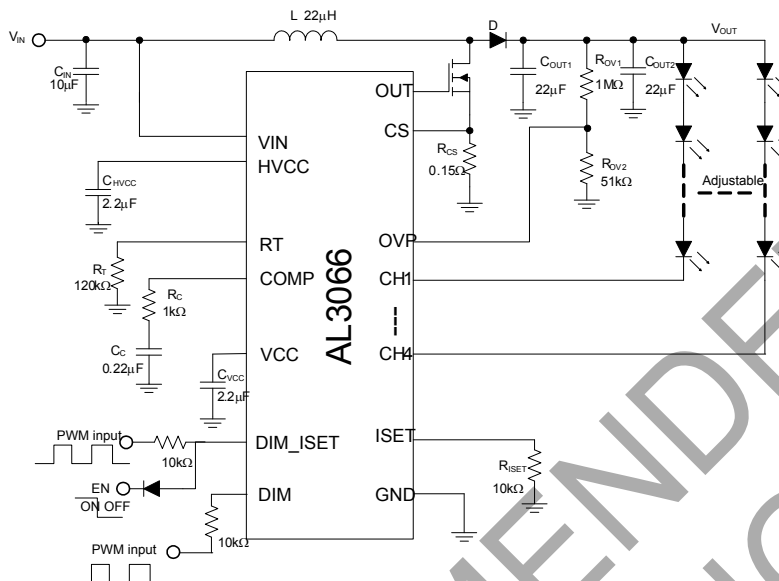

Pin Descriptions

Pin Number	Pin Name	Function
1	CH4	LED current sink 4. Leave the pin open directly if not used.
2	ISET	LED current set pin. The corresponding maximum current of all 4 strings is set through connecting a resistor from this pin to GND.
3	OVP	Overvoltage protection pin. When the OVP pin voltage exceeds 2.0V, the OVP is triggered and the power switch is turned off. When the OVP pin voltage drops below Hysteresis voltage, the OVP is released and the power switch will resume normal operation.
4	RT	Frequency control pin.
5	CS	Power switch current sense input.
6	OUT	Boost converter power switch gate output. This pin outputs high voltage (10V) to drive the external N-MOSFET.
7	VCC	5V linear regulator output pin. This pin should be bypassed to GND with a ceramic capacitor.
8	HVCC	10V linear regulator output pin. This pin should be bypassed to GND with a ceramic capacitor.
9	VIN	Supply input pin. A capacitor (typical 10µF) should be connected between the VIN and GND to keep the DC input voltage constant.
10	DIM_ISET	PWM to Analog dimming pin and Enable pin. Apply a PWM signal to this pin to adjust ISET pin reference to regulate the output current.
11	COMP	Soft-start and control loop compensation.
12	DIM	PWM control dimming MOSFET pin. Apply a PWM signal to this pin to control LED dimming.
13	CH1	LED current sink 1. Leave the pin open directly if not used.
14	CH2	LED current sink 2. Leave the pin open directly if not used.
15	GND	Ground
16	CH3	LED current sink 3. Leave the pin open directly if not used.

Functional Block Diagram

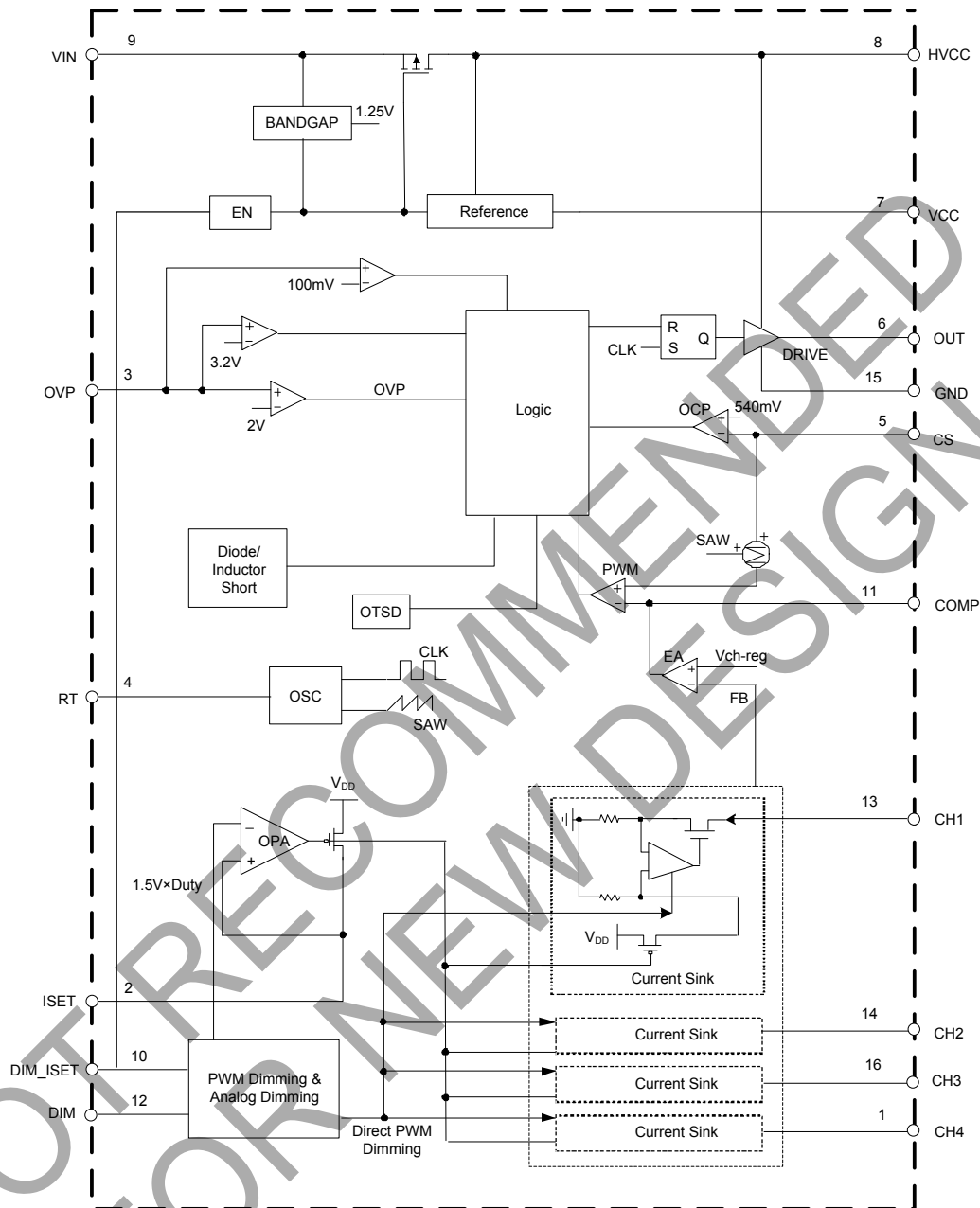

Absolute Maximum Ratings (@T_A = +25°C, unless otherwise specified. Note 4, 5)

Symbol	Parameter	Rating	Unit
V _{IN}	Input Voltage	-0.3 to 40	V
V _{EN}	EN Pin Voltage	-0.3 to 7	V
V _{CC}	VCC Pin Voltage	-0.3 to 7	V
HV _{CC}	HVCC Pin Voltage	-0.3 to 20	V
V _{CH}	CH1 to CH4 Pins Voltage	-0.3 to 60	V
V _{CS}	CS Pin Voltage	-0.3 to 42	V
V _{COMP}	COMP Pin Voltage	-0.3 to 7	V
V _{ISET}	ISET Pin Voltage	-0.3 to 7	V
V _{OUT}	OUT Pin Voltage	-0.3 to 20	V
V _{OVP}	OVP Pin Voltage	-0.3 to 42	V
V _{RT}	RT Pin Voltage	-0.3 to 7	V
V _{DIM_ISET}	DIM_ISET Pin Voltage	-0.3 to 7	V
V _{DIM}	DIM Pin Voltage	-0.3 to 7	V
V _{GND}	GND Pin Voltage	-0.3 to 0.3	V
θ _{JA}	Thermal Resistance (Junction to Ambient) (Note 6)	79	°C /W
θ _{JC}	Thermal Resistance (Junction to Case) (Note 6)	10	°C /W
T _J	Operating Junction Temperature	+150	°C
T _{STG}	Storage Temperature	-65 to +150	°C
T _{LEAD}	Lead Temperature (Soldering, 10sec)	+260	°C
-	ESD (Machine Model)	200	V
-	ESD (Human Body Model)	4000	V

Note: 4. Stresses greater than those listed under "Absolute Maximum Ratings" may cause permanent damage to the device. These are stress ratings only and functional operation of the device at these or any other conditions beyond those indicated under "Recommended Operating Conditions" are not implied. Exposure to "Absolute Maximum Ratings" for extended periods may affect device reliability.

5. For better performance, the AL3066 should have high voltage pins CS and OVP. If CS or OVP pin is added to 16V, the IC will not smoke or burn.

6. Device mounted on 2"x2" FR-4 substrate PCB, 2oz copper, with minimum recommended pad layout.

Recommended Operating Conditions

Symbol	Parameter	Min	Max	Unit
V _{IN}	Input Voltage	4.5	33	V
f _o	Operating Frequency	0.1	1	MHz
I _{CH}	LED Channel Current	20	400	mA
f _{PWM1}	DIM pin PWM Dimming Frequency	0.1	25	kHz
f _{PWM2}	DIM_ISET Pin PWM Dimming Frequency	10	100	kHz
T _A	Operating Ambient Temperature	-40	+85	°C

Electrical Characteristics (@ $T_A=+25^{\circ}\text{C}$, $V_{IN}=12\text{V}$, $V_{DIM_ISET}=5\text{V}$, unless otherwise specified.)

Symbol	Parameter	Condition	Min	Typ	Max	Unit
Input Supply						
V_{IN}	Input Voltage	-	4.5	-	33	V
I_Q	Quiescent Current	$V_{DIM}=0\text{V}$, $V_{DIM_ISET}=5\text{V}$	-	3	-	mA
		$V_{DIM}=V_{DIM_ISET}=5\text{V}$	-	5	-	mA
I_{SHDN}	Shutdown Supply Current	$V_{DIM_ISET}=0\text{V}$	-	1	-	μA
V_{UVLO}	Under-Voltage Lockout Voltage	V_{IN} Rising	3.7	4.0	4.3	V
V_{HYS}	UVLO Hysteresis	-	-	200	-	mV
V_{CC} Regulator						
HV_{CC}	HV_{CC} Voltage	$V_{IN}\geq 10.5\text{V}$	-	10	-	V
		$V_{IN}< 10.5\text{V}$	-	$V_{IN}-0.5$	-	V
V_{CC}	V_{CC} Voltage	$V_{IN}\geq 5.5\text{V}$	-	5	-	V
		$V_{IN}< 5.5\text{V}$	-	$V_{IN}-0.5$	-	V
t_{RISE}	OUT Pin Rise Time	OUT Pin Load = 1nF	-	30	-	ns
t_{FALL}	OUT Pin Fall Time	OUT Pin Load = 1nF	-	30	-	ns
-	Load Regulation	Load=0 to 30mA	-	5	-	mV/mA
-	Line Regulation	$V_{IN}=12\text{V}$ to 33V	-	0.3	-	mV/V
High Frequency Oscillator						
f_{OSC1}	Switch Frequency	$R_T=100\text{k}\Omega$	450	500	550	kHz
-	Switch Frequency Range	-	0.1	-	1	MHz
D_{MAX}	Max. Duty Cycle	$R_T=100\text{k}\Omega$	80	90	-	%
Enable Logic and Dimming Logic						
$V_{DIM_ISET_H}$	DIM_ISET Logic for External Dimming	Logic High	2.5	-	-	V
$V_{DIM_ISET_L}$		Logic Low	-	-	0.3	V
V_{DIM_H}	DIM Logic for External Dimming	Logic High	2.5	-	-	V
V_{DIM_L}		Logic Low	-	-	0.3	V
Power Switch Drive						
V_{LIMIT1}	Current Limit Threshold Voltage	-	480	540	600	mV
V_{LIMIT2}	D/L Short Threshold Voltage	-	720	800	880	mV
t_{LEB}	Current Sense LEB Time (Note 7)	-	80	100	150	ns
Compensation and Soft Start (COMP Pin)						
I_{O_H}	Sourcing Current	$V_{COMP}=0.5\text{V}$	-	120	-	μA
I_{O_L}	Sinking Current	$V_{COMP}=2\text{V}$	-	120	-	μA

Electrical Characteristics (Cont. @T_A=+25°C, V_{IN}=12V, V_{DIM_ISET}=5V, unless otherwise specified.)

Symbol	Parameter	Condition	Min	Typ	Max	Unit
Over Voltage Protection						
V _{OVP}	OVP Threshold Voltage	V _{OUT} Rising	1.9	2.0	2.1	V
V _{OVP_HYS}	OVP Hysteresis	-	-	200	-	mV
V _{OVP-SH}	Shutdown Under Abnormal Condition	-	3.0	3.2	3.4	V
Current Source						
I _{CH_MATCH}	LED Current Matching between Each String (Note 8)	I _{CH} =100mA	-	1.5	2.7	%
I _{CH}	Regulation Current per Channel	R _{ISET} =12kΩ	97	100	103	mA
V _{LED_REG}	Minimum LED Regulation Voltage	I _{CH} =120mA	-	500	-	mV
I _{LED_LEAK}	CH1 to CH4 Leakage Current	V _{EN} =0V, V _{LED} =37V	-	0.1	1	μA
V _{LED-S}	LED Short Protection Threshold	-	4.9	5.4	5.9	V
Over Temperature Protection						
T _{OTSD}	Thermal Shutdown Temperature (Note 7)	-	+155	+160	+165	°C
T _{HYS}	Thermal Shutdown Temperature Hysteresis (Note 7)	-	-	+30	-	°C

Notes: 7. Guaranteed by Design.

$$8. I_{CH_MATCH} = \frac{I_{MAX} - I_{MIN}}{2 \times I_{AVG}} \times 100\%$$

Typical Performance Characteristic (@ $T_A = +25^\circ\text{C}$, $V_{IN}=24\text{V}$, $V_{DIM_ISET}=V_{DIM}=5\text{V}$, unless otherwise specified.)

Frequency vs. RT Resistor

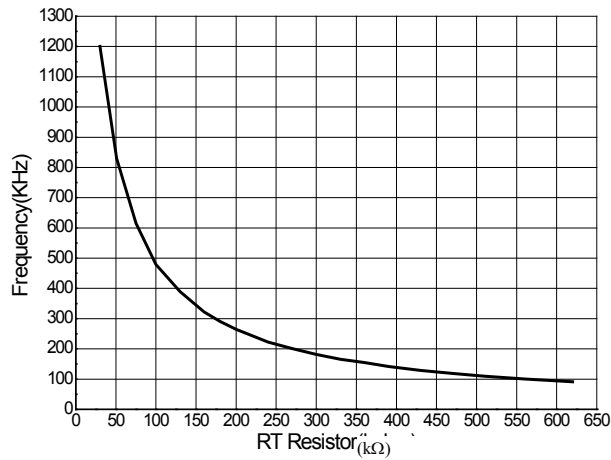

VCC Voltage vs. VIN pin Voltage

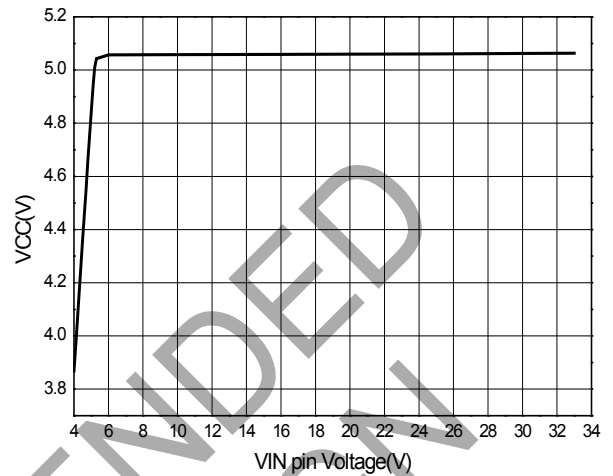

HVCC Voltage vs. VIN pin Voltage

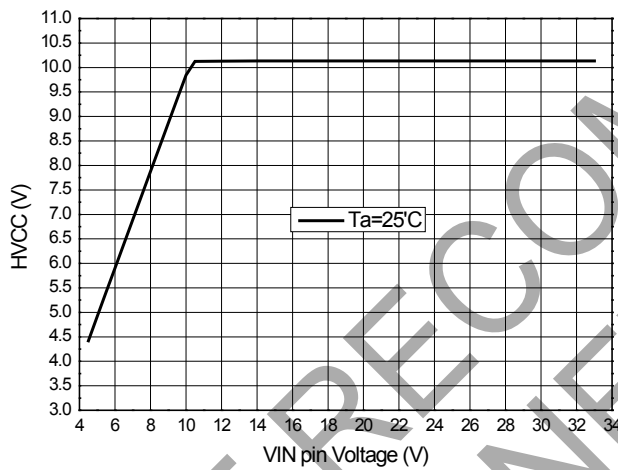

CHX pin Regulation Voltage vs. Output Current / CH

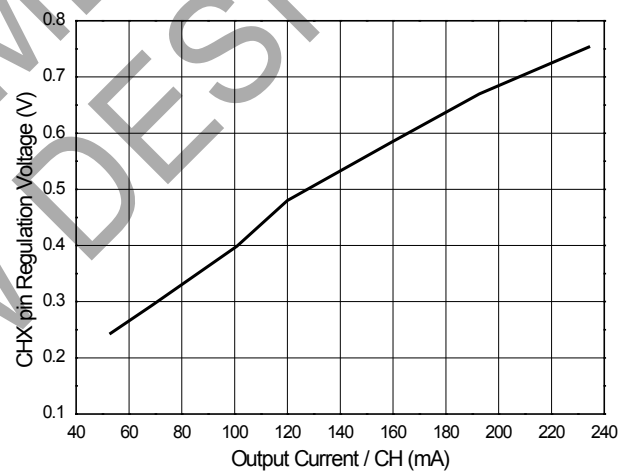

CHX pin Regulation Voltage vs. Temperature

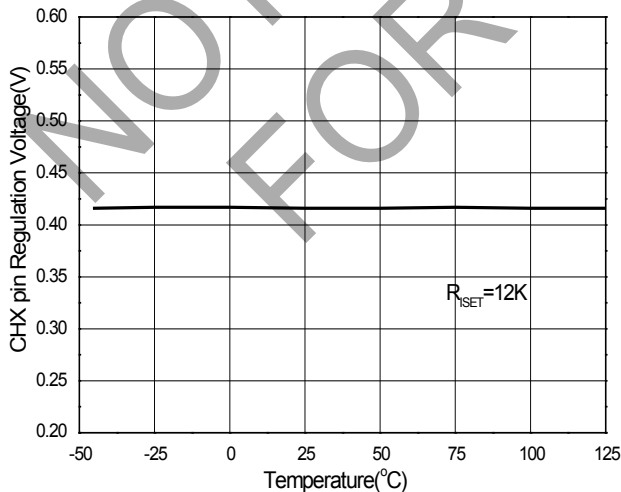

Channel Current vs. Channel

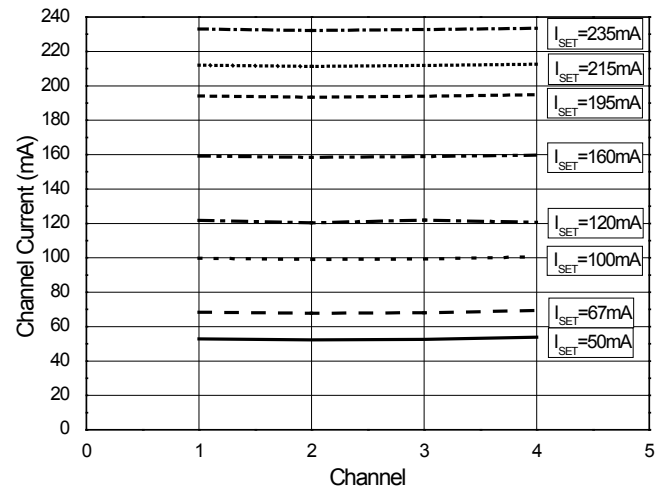

Typical Performance Characteristic (@ $T_A = +25^\circ\text{C}$, $V_{IN} = 24\text{V}$, $V_{DIM_ISET} = V_{DIM} = 5\text{V}$, unless otherwise specified.)

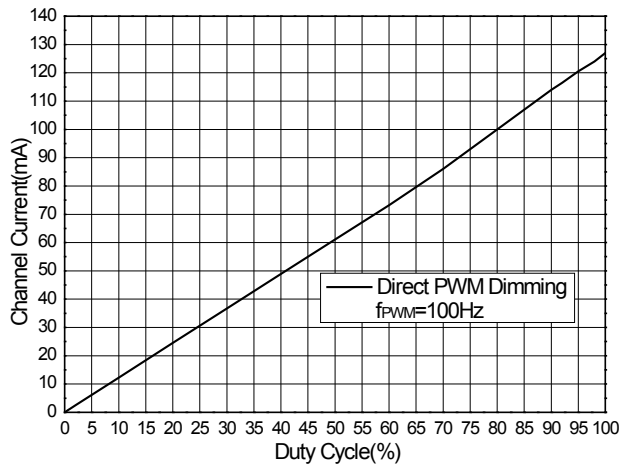
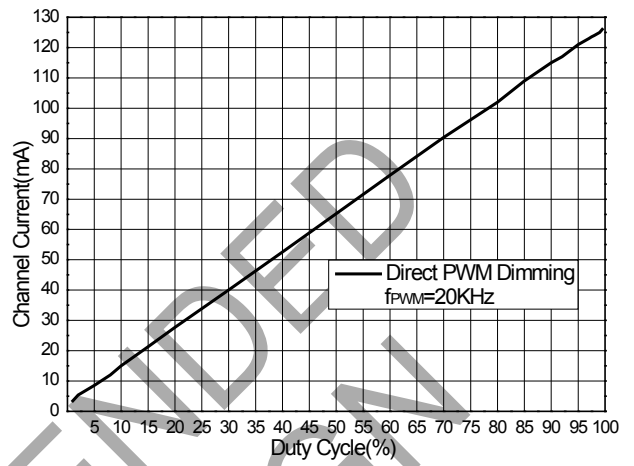
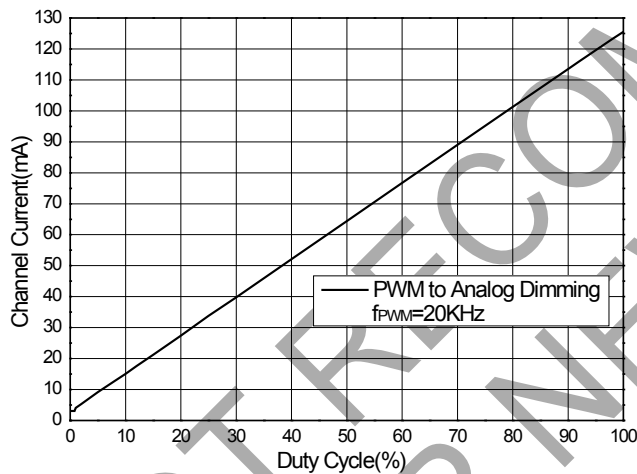
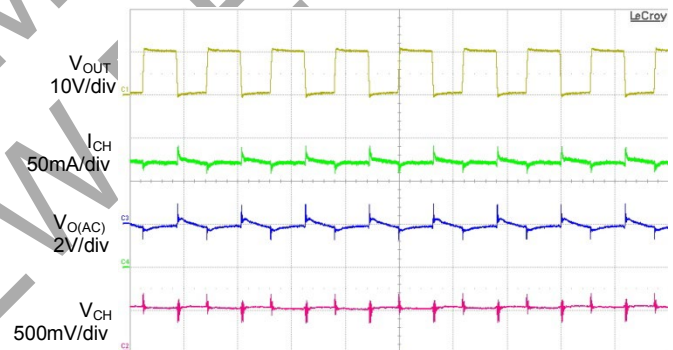
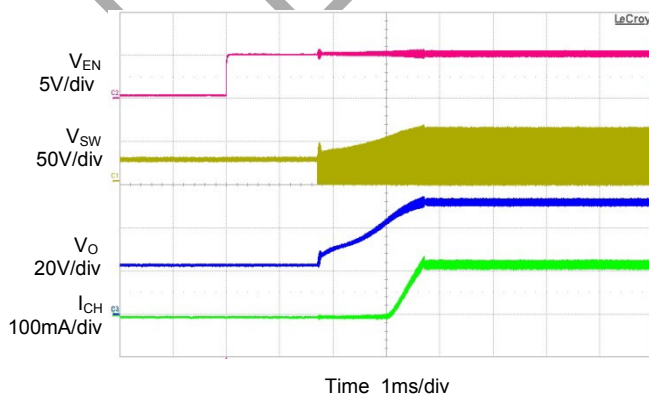
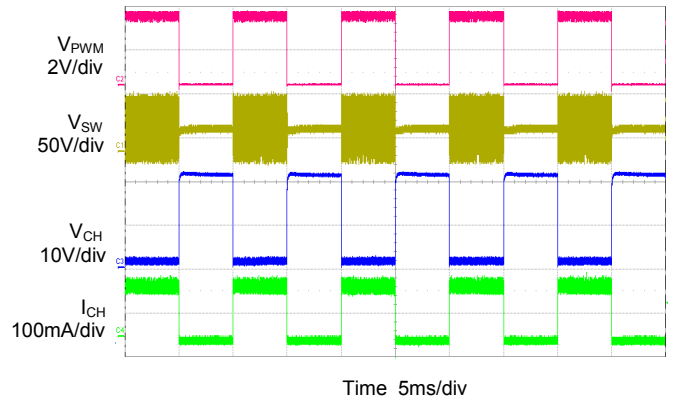
Direct PWM Dimming @ $f_{PWM} = 100\text{Hz}$
Channel Current vs. Duty Cycle

Direct PWM Dimming @ $f_{PWM} = 20\text{kHz}$
Channel Current vs. Duty Cycle

PWM to Analog Dimming @ $f_{PWM} = 20\text{kHz}$
Channel Current vs. Duty Cycle

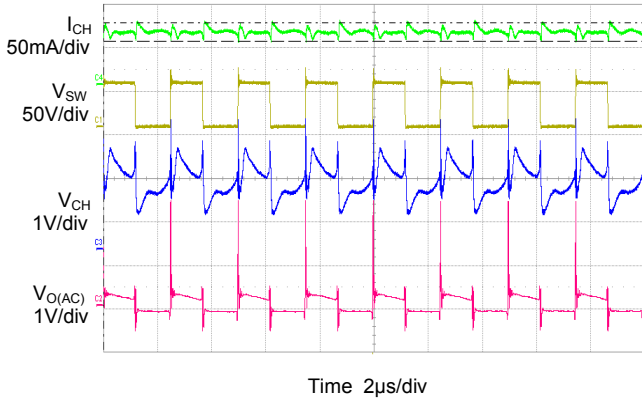
Steady State

System Startup

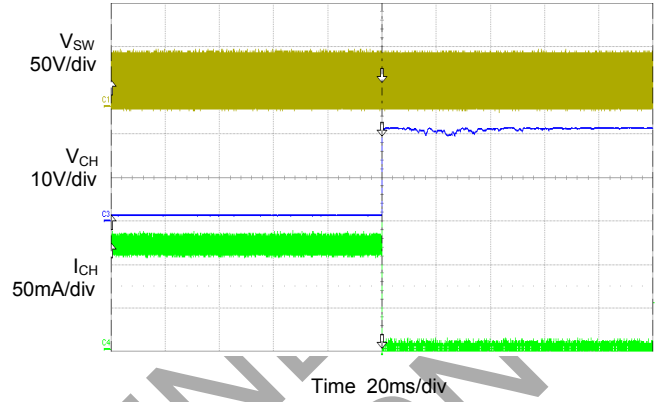
Direct PWM Dimming

Typical Performance Characteristic (@ $T_A = +25^\circ\text{C}$, $V_{IN}=24\text{V}$, $V_{DIM_ISET}=V_{DIM}=5\text{V}$, unless otherwise specified.)

PWM to Analog Dimming



LED Short Protection



LED Open Protection

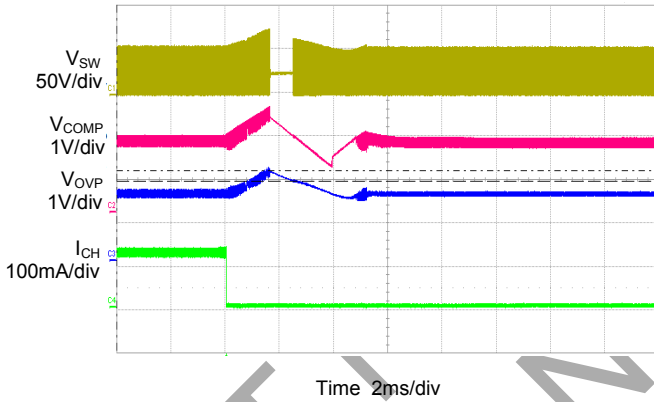

Schottky/Inductor Short Protection

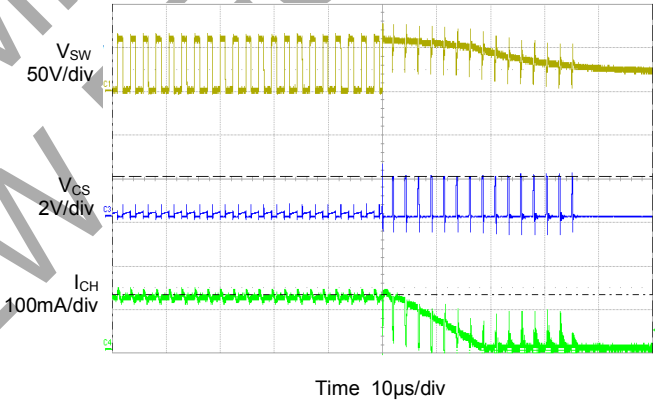

VOUT Short/Diode Open Protection

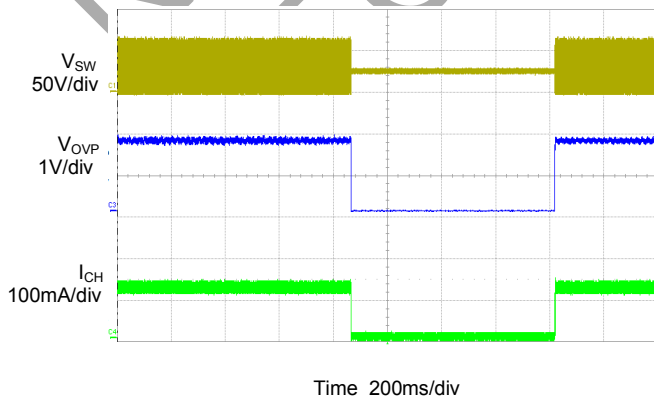

Over Temperature Protection

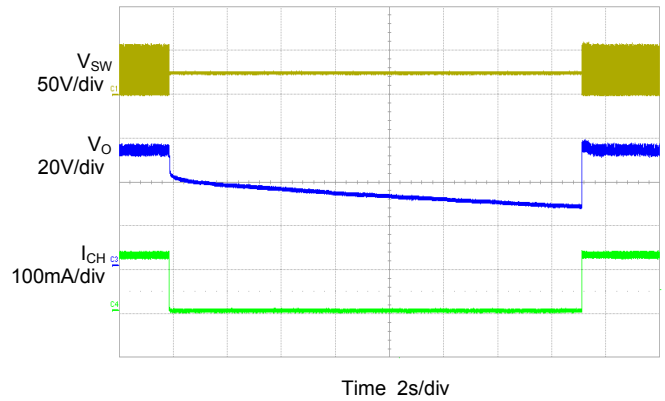

Application Information

Enable

The AL3066 is enabled when the voltage at EN pin is greater than approximately 2.4V, and disabled when lower than 0.5V.

Frequency Selection

An external resistor R_T , placed between RT pin and GND, can be used to set the operating frequency. The operating frequency ranges from 100kHz to 1MHz. The high frequency operation optimizes the regulator for the smallest-sized component application, while low frequency operation can help to reduce switch loss. The approximate operating frequency can be expressed as below:

$$f_{OSC}[MHz] = \frac{52}{R_T[K\Omega]}$$

LED Current Setting

The maximum LED current per channel can be adjusted up to 400mA via ISET pin. When $\geq 400mA$ current is needed in application, two or more channels can be paralleled to provide larger drive current. A resistor R_{ISET} is connected between ISET pin and GND to set the reference current I_{SET} . The LED current can be expressed as below:

$$I_{LED}[mA] = \frac{1200}{R_{ISET}[K\Omega]}$$

Dimming Control

1.) Direct PWM Dimming Control

Compared to Analog dimming, PWM dimming offers superior dimming resolution and reduced LED color shift. Apply a PWM signal to the DIM pin to achieve direct PWM dimming. The LED current of all enabled channels can be adjusted at the same time and the LED brightness can be adjusted from $1\% \times I_{CH_MAX}$ to $100\% \times I_{CH_MAX}$.

During the "high level" period of PWM signal, the LED is turned on and 100% of the current flows through the LED, while during the "low level" period of the PWM signal, the LED is turned off and almost no current flows through the LED. Changing the average current through the LED can adjust the LED brightness.

The external PWM signal frequency applied to DIM pin can be 100Hz or higher and the minimum PWM duty can be 1/10,000 at 100Hz dimming frequency.

2.) PWM to Analog Dimming Control

Apply a PWM signal to DIM_ISET pin to modulate ISET pin reference voltage to achieve PWM to analog dimming. The AL3066 chops up the internal reference voltage at the duty cycle of the PWM signal. The pulse signal is then filtered by an internal low pass filter. The output of this filter contains an average DC component as ISET pin reference voltage thereby modulating the amplitude of the LED current.

3-Channel Operation

For applications where only three LED strings are used, the AL3066 provides design flexibility by disabling the unused channel in two methods.

1.) Disable the unused channel by floating

Leave any of the 4 channels (CH1~CH4) floating to disable the unused channel. The AL3066 integrates an LED Open-Circuit Protection circuit. At each start up, VOUT will boost up until the voltage at OVP pin reaches an approximate threshold of 2.0V and then disable the floating channel, the remaining channels will continue normal operation.

2.) Disable the third channel CH3 by pulling high

Disable the third channel CH3 by pulling CH3 high to a DC voltage higher than LED short protection threshold (5.4V typically), usually connected to HVCC pin. The AL3066 integrates an LED Short-Circuit Protection circuit. If the voltage at CH3 pin exceeds a threshold of approximately 5.4V during normal operation, CH3 is disabled. At each start up, CH3 will be disabled and the remaining channels will continue normal operation.

Application Information (Cont.)

Protection

1.) Over Voltage Protection

The AL3066 integrates an OVP circuit. The OVP pin is connected to the center tap of voltage-divider (ROV1 and ROV2) connected between high voltage output and GND.

If the voltage at OVP pin exceeds 2.0V, which may result from open loop or excessive output voltage, all the functions of the AL3066 will be disabled with output voltage falling. The OVP hysteresis is 200mV.

2.) Over-Current Protection

The AL3066 integrates an OCP circuit. The CS pin is connected to the voltage-sensor (RCS) placed between the source of the MOSFET and GND. If the voltage at CS pin exceeds 0.54V, the MOSFET is turned off immediately and will not turn on until the next cycle begins.

3.) LED Short-Circuit Protection

The AL3066 integrates an LED Short-Circuit Protection circuit. If the voltage at any of the CH1 to CH4 pins exceeds a threshold of approximately 5.4V during normal operation, the corresponding channel is latched off. Toggle V_{IN} or EN to reset the latch. LED short detecting logic priority is lower than open LED and OVP logic. The LED short detecting is triggered when $0.1V < V_{LED_MIN}$ under dimming on mode, and disabled when LED open occurs until output voltage resumes to the regulated voltage.

4.) LED Open-Circuit Protection

The AL3066 integrates an LED Open-Circuit Protection circuit. When any LED string is open, V_{OUT} will boost up until the voltage at OVP pin reaches an approximate threshold of 2.0V. The IC will automatically ignore the open string whose corresponding pin voltage is less than 100mV and the remaining string will continue operation. If all the strings are open and the voltage at OVP pin reaches a threshold of 2.0V, the MOSFET drive gate will turn off and the IC will shut down and latch.

5.) V_{OUT} Short/Open Schottky Diode Protection

The AL3066 monitors the OVP pin, if the OVP pin voltage is less than 0.1V, MOSFET drive output will turn off. This protects the converter if the output Schottky diode is open or V_{OUT} is shorted to ground.

6.) Under-Voltage Lockout

The AL3066 provides an under voltage lockout circuit to prevent it from undefined status when it starts up. The UVLO circuit shuts down the device when V_{CC} drops below 3.8V. The UVLO circuit has 200mV hysteresis, which means the device starts up again when V_{CC} rises to 4.0V.

7.) Over-Temperature Protection

The AL3066 features Over-Temperature Protection. If the junction temperature exceeds approximately +160°C, the IC will shut down until the junction temperature is less than approximately +140°C. When the IC is released from over temperature shutdown, it will start a soft-start process.

8.) Schottky Diode/Inductor Short-Circuit Protection

The AL3066 features Schottky Diode/Inductor Short-Circuit protection circuit. When CS pin voltage exceeds 0.8V for greater than 16 switching clocks, the IC will latch off. The voltage of CS pin is monitored after a short delay of t_{LEB} .

9.) Shut Down under Abnormal Condition

The AL3066 features Shutdown under Abnormal Condition Protection circuit. When the OVP pin voltage exceeds 3.2V, the IC will latch off. Toggle EN pin to restart the IC. This feature can be used to shut down the IC under any defined abnormal condition.

Ordering Information

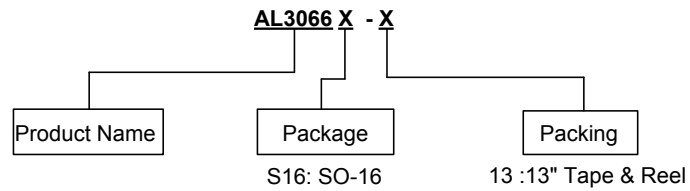

Part Number	Package Code	Package	13" Tape & Reel	
			Quantity	Part Number Suffix
AL3066S16-13	S16	SO-16	2500	-13

Marking Information

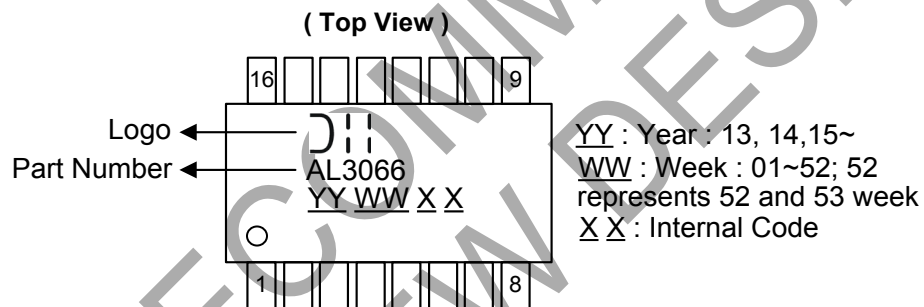

Package Outline Dimensions

Please see <http://www.diodes.com/package-outlines.html> for the latest version.

SO-16

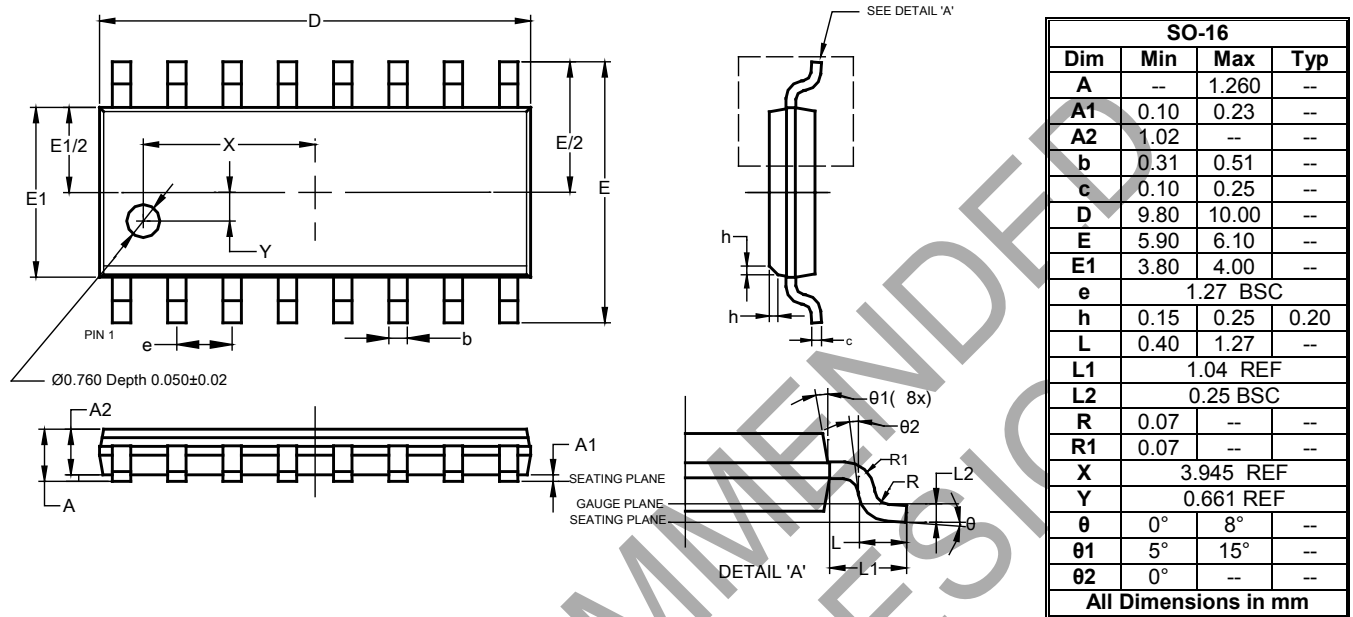

Suggested Pad Layout

Please see <http://www.diodes.com/package-outlines.html> for the latest version.

SO-16

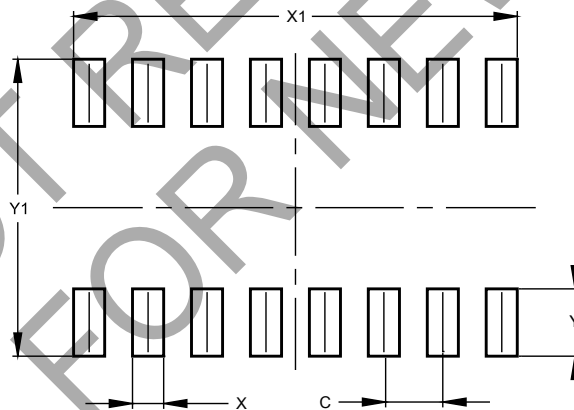

Dimensions	Value (in mm)
C	1.270
X	0.670
X1	9.560
Y	1.450
Y1	6.400

IMPORTANT NOTICE

1. DIODES INCORPORATED AND ITS SUBSIDIARIES ("DIODES") MAKE NO WARRANTY OF ANY KIND, EXPRESS OR IMPLIED, WITH REGARDS TO ANY INFORMATION CONTAINED IN THIS DOCUMENT, INCLUDING, BUT NOT LIMITED TO, THE IMPLIED WARRANTIES OF MERCHANTABILITY, FITNESS FOR A PARTICULAR PURPOSE OR NON-INFRINGEMENT OF THIRD PARTY INTELLECTUAL PROPERTY RIGHTS (AND THEIR EQUIVALENTS UNDER THE LAWS OF ANY JURISDICTION).
2. The Information contained herein is for informational purpose only and is provided only to illustrate the operation of Diodes products described herein and application examples. Diodes does not assume any liability arising out of the application or use of this document or any product described herein. This document is intended for skilled and technically trained engineering customers and users who design with Diodes products. Diodes products may be used to facilitate safety-related applications; however, in all instances customers and users are responsible for (a) selecting the appropriate Diodes products for their applications, (b) evaluating the suitability of the Diodes products for their intended applications, (c) ensuring their applications, which incorporate Diodes products, comply the applicable legal and regulatory requirements as well as safety and functional-safety related standards, and (d) ensuring they design with appropriate safeguards (including testing, validation, quality control techniques, redundancy, malfunction prevention, and appropriate treatment for aging degradation) to minimize the risks associated with their applications.
3. Diodes assumes no liability for any application-related information, support, assistance or feedback that may be provided by Diodes from time to time. Any customer or user of this document or products described herein will assume all risks and liabilities associated with such use, and will hold Diodes and all companies whose products are represented herein or on Diodes' websites, harmless against all damages and liabilities.
4. Products described herein may be covered by one or more United States, international or foreign patents and pending patent applications. Product names and markings noted herein may also be covered by one or more United States, international or foreign trademarks and trademark applications. Diodes does not convey any license under any of its intellectual property rights or the rights of any third parties (including third parties whose products and services may be described in this document or on Diodes' website) under this document.
5. Diodes products are provided subject to Diodes' Standard Terms and Conditions of Sale (<https://www.diodes.com/about/company/terms-and-conditions/terms-and-conditions-of-sales/>) or other applicable terms. This document does not alter or expand the applicable warranties provided by Diodes. Diodes does not warrant or accept any liability whatsoever in respect of any products purchased through unauthorized sales channel.
6. Diodes products and technology may not be used for or incorporated into any products or systems whose manufacture, use or sale is prohibited under any applicable laws and regulations. Should customers or users use Diodes products in contravention of any applicable laws or regulations, or for any unintended or unauthorized application, customers and users will (a) be solely responsible for any damages, losses or penalties arising in connection therewith or as a result thereof, and (b) indemnify and hold Diodes and its representatives and agents harmless against any and all claims, damages, expenses, and attorney fees arising out of, directly or indirectly, any claim relating to any noncompliance with the applicable laws and regulations, as well as any unintended or unauthorized application.
7. While efforts have been made to ensure the information contained in this document is accurate, complete and current, it may contain technical inaccuracies, omissions and typographical errors. Diodes does not warrant that information contained in this document is error-free and Diodes is under no obligation to update or otherwise correct this information. Notwithstanding the foregoing, Diodes reserves the right to make modifications, enhancements, improvements, corrections or other changes without further notice to this document and any product described herein. This document is written in English but may be translated into multiple languages for reference. Only the English version of this document is the final and determinative format released by Diodes.
8. Any unauthorized copying, modification, distribution, transmission, display or other use of this document (or any portion hereof) is prohibited. Diodes assumes no responsibility for any losses incurred by the customers or users or any third parties arising from any such unauthorized use.

Copyright © 2021 Diodes Incorporated

www.diodes.com

OUR CERTIFICATE

DiGi provide top-quality products and perfect service for customer worldwide through standardization, technological innovation and continuous improvement. DiGi through third-party certification, we stricly control the quality of products and services. Welcome your RFQ to

Email: Info@DiGi-Electronics.com



Tel: +00 852-30501935

RFQ Email: Info@DiGi-Electronics.com

DiGi is a global authorized distributor of electronic components.