

# AP2213D-2.5TRG1 Datasheet

[www.digi-electronics.com](http://www.digi-electronics.com)

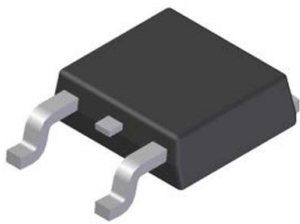

<https://www.DiGi-Electronics.com>

DiGi Electronics Part Number	AP2213D-2.5TRG1-DG
Manufacturer	<a href="#">Diodes Incorporated</a>
Manufacturer Product Number	AP2213D-2.5TRG1
Description	IC REG LINEAR 2.5V 500MA TO252-2
Detailed Description	Linear Voltage Regulator IC Positive Fixed 1 Output 500mA TO-252-3



Tel: +00 852-30501935

RFQ Email: [Info@DiGi-Electronics.com](mailto:Info@DiGi-Electronics.com)

DiGi is a global authorized distributor of electronic components.

## Purchase and inquiry

Manufacturer Product Number:

AP2213D-2.5TRG1

Series:

-

Output Configuration:

Positive

Number of Regulators:

1

Voltage - Output (Min/Fixed):

2.5V

Voltage Dropout (Max):

0.7V @ 500mA

Current - Quiescent (Iq):

180  $\mu$ A

PSRR:

75dB (100Hz)

Protection Features:

Over Current, Over Temperature, Reverse Polarity

Mounting Type:

Surface Mount

Supplier Device Package:

TO-252-3

Manufacturer:

Diodes Incorporated

Product Status:

Obsolete

Output Type:

Fixed

Voltage - Input (Max):

18V

Voltage - Output (Max):

-

Current - Output:

500mA

Current - Supply (Max):

28 mA

Control Features:

-

Operating Temperature:

-40°C ~ 125°C

Package / Case:

TO-252-3, DPAK (2 Leads + Tab), SC-63

Base Product Number:

AP2213

## Environmental & Export classification

RoHS Status:

ROHS3 Compliant

REACH Status:

REACH Unaffected

HTSUS:

8542.39.0001

Moisture Sensitivity Level (MSL):

1 (Unlimited)

ECCN:

EAR99



AP2213

500mA LOW NOISE LDO REGULATOR

## Description

The AP2213 is a 500mA output current fixed voltage regulator which provides low noise, very low dropout voltage (typically 350mV at 500mA), very low standby current (1 $\mu$ A maximum), and excellent power supply ripple rejection (PSRR 75dB at 100Hz). This device is used in battery-powered applications, such as handsets and PDAs; and in noise sensitive applications, such as RF electronics.

The AP2213 features individual logic compatible enable/shutdown control inputs, a low power shutdown mode for extended battery life, over-current protection, over-temperature protection, and reversed current protection.

The AP2213 has 2.5V, 3.0V, and 3.3V versions.

The AP2213 is available in the TO-252-2 (3), SOIC-8, and SOT-223 packages.

## Features

- Up to 500mA Output Current
- Low Standby Current
- Low Dropout Voltage:  $V_{DROP} = 350\text{mV}$  at 500mA
- High Output Accuracy:  $\pm 1\%$
- Good Ripple Rejection Ability: 75dB at 100Hz and  $I_{OUT} = 100\mu\text{A}$
- Tight Load and Line Regulation
- Low Temperature Coefficient
- Over Current Protection
- Thermal Protection
- Reversed Current Protection
- Logic-Controlled Enable
- Moisture Sensitivity: Level 3 per J-STD-020
- Terminals: Finish—Matte Tin Plated Leads, Solderable per MIL-STD-202, Method 208 
- Weight:
  - TO252-2 (3): 0.312 grams (Approximate)
  - SOT-223: 0.116 grams (Approximate)
  - SOIC-8: 0.077 grams (Approximate)
- Lead-Free Packages: TO-252-2 (3), SOT-223, SOIC-8
  - **Totally Lead-Free; RoHS Compliant (Notes 1 & 2)**
- Lead-Free Packages, Available in "Green" Molding Compound: TO-252-2 (3), SOT-223, SOIC-8
  - **Totally Lead-Free & Fully RoHS Compliant (Notes 1 & 2)**
  - **Halogen- and Antimony-Free. "Green" Device (Note 3)**
- **For automotive applications requiring specific change control (i.e. parts qualified to AEC-Q100/101/200, PPAP capable, and manufactured in IATF 16949 certified facilities), please [contact us](https://www.diodes.com/contact-us) or your local Diodes representative.**

<https://www.diodes.com/quality/product-definitions/>

- Notes:
1. No purposely added lead. Fully EU Directive 2002/95/EC (RoHS), 2011/65/EU (RoHS 2) & 2015/863/EU (RoHS 3) compliant.
  2. See <https://www.diodes.com/quality/lead-free/> for more information about Diodes Incorporated's definitions of Halogen- and Antimony-free, "Green" and Lead-free.
  3. Halogen- and Antimony-free "Green" products are defined as those which contain <900ppm bromine, <900ppm chlorine (<1500ppm total Br + Cl) and <1000ppm antimony compounds.

## Pin Assignments

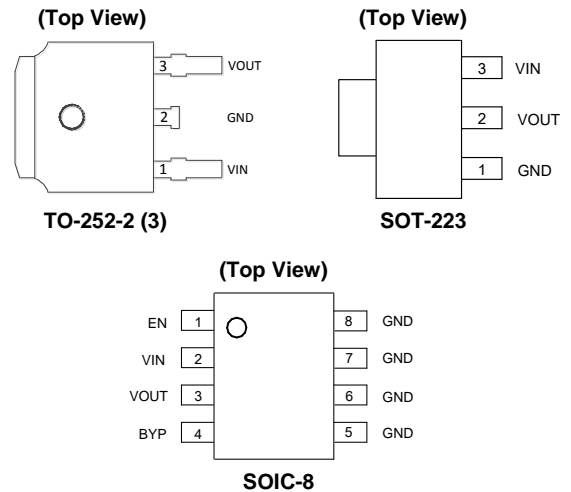

## Applications

- Laptop, Notebook, and Palmtop Computer
- CD-ROM, CD-R/RW, DVD Driver
- Portable Electronic
- PC Peripheral

## Typical Applications Circuit (Note 4)

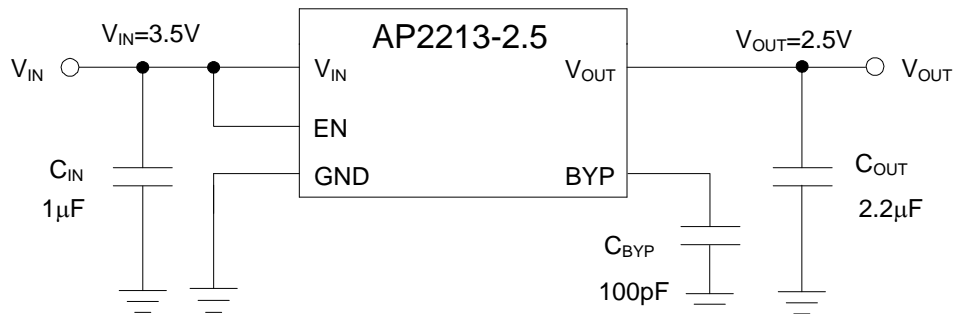

Notes: 4. Dropout voltage is 350mV when  $T_A = +25^\circ\text{C}$ . In order to obtain a normal output voltage,  $V_{OUT}+0.35\text{V}$  is the minimum input voltage which will result in a low PSRR, imposing a bad influence on system. Therefore, the recommended input voltage is  $V_{OUT}+1\text{V}$  to 18V. For AP2213-2.5 version, its input voltage can be set from  $3.5\text{V}(V_{OUT}+1\text{V})$  to 18V.

## Pin Descriptions

Pin Number			Pin Name	Function
TO-252-2 (3)	SOIC-8	SOT-223		
3	3	2	VOUT	Regulated output voltage
2	5, 6, 7, 8	1	GND	Ground
1	2	3	VIN	Input Voltage
—	1	—	EN	Enable input: CMOS or TTL compatible input. Logic high = enable, logic low = shutdown
—	4	—	BYP	Bypass capacitor for low noise operation

## Functional Block Diagram

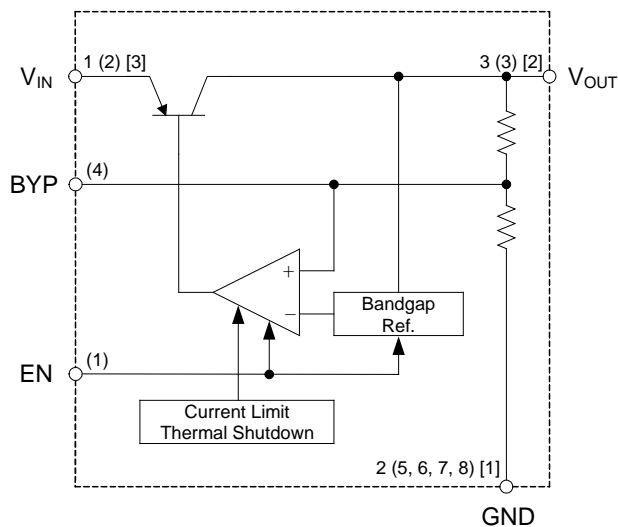

A (B) [C]  
 A for TO-252-2 (3)  
 B for SOIC-8  
 C for SOT-223



## Absolute Maximum Ratings (Note 5)

Symbol	Parameter	Rating		Unit
$V_{IN}$	Supply Input Voltage	20		V
$V_{EN}$	Enable Input Voltage	20		V
$P_D$	Power Dissipation	Internally Limited (Thermal Protection)		W
$T_{LEAD}$	Lead Temperature (Soldering, 10s)	+260		°C
$T_J$	Junction Temperature	+150		°C
$T_{STG}$	Storage Temperature	-65 to +150		°C
ESD	ESD (Machine Model)	300		V
	ESD (Human Body Model)	6000		
	ESD (Charge Device Model)	2000		
$\theta_{JA}$	Thermal Resistance (No Heatsink)	TO-252-2 (3)	90	°C/W
		SOIC-8	160	
		SOT-223	108	

Notes: 5. Stresses greater than those listed under "Absolute Maximum Ratings" can cause permanent damage to the device. These are stress ratings only, and functional operation of the device at these or any other conditions beyond those indicated under "Recommended Operating Conditions" is not implied. Exposure to "Absolute Maximum Ratings" for extended periods can affect device reliability.

## Recommended Operating Conditions

Symbol	Parameter	Min	Max	Unit
$V_{IN}$	Supply Input Voltage	2.5	18	V
$V_{EN}$	Enable Input Voltage	0	18	V
$T_J$	Operating Junction Temperature	-40	+125	°C



AP2213

**AP2213-2.5 Electrical Characteristics** (@ $V_{IN} = 3.5V$ ,  $I_{OUT} = 100\mu A$ ,  $C_{IN} = 1.0\mu F$ ,  $C_{OUT} = 2.2\mu F$ ,  $V_{EN} \geq 2.0V$ ,  $T_J = +25^\circ C$ , **Bold** typeface applies over  $-40^\circ C \leq T_J \leq +125^\circ C$  (Note 6), unless otherwise specified.)

Symbol	Parameter	Conditions	Min	Typ	Max	Unit
$\Delta V_{OUT}/V_{OUT}$	Output Voltage Accuracy	Variation from Specified $V_{OUT}$	-1	—	1	%
			<b>-2</b>	—	<b>2</b>	
$\Delta V_{OUT}/\Delta T$	Output Voltage Temperature Coefficient (Note 7)	—	—	<b>120</b>	—	$\mu V/^\circ C$
$(\Delta V_{OUT}/V_{OUT})/\Delta T$			—	<b>48</b>	—	ppm/ $^\circ C$
$V_{RLINE}$	Line Regulation	$V_{IN} = 3.5V$ to $13.2V$	—	1.5	4.5	mV
			—	—	<b>12</b>	
$V_{RLOAD}$	Load Regulation (Note 8)	$I_{OUT} = 0.1mA$ to $500mA$	—	1	7	mV
			—	—	<b>17</b>	
$V_{DROP}$	Dropout Voltage (Note 9)	$I_{OUT} = 100\mu A$	—	15	50	mV
			—	—	<b>70</b>	
		$I_{OUT} = 50mA$	—	110	150	
			—	—	<b>230</b>	
		$I_{OUT} = 100mA$	—	140	250	
			—	—	<b>300</b>	
		$I_{OUT} = 150mA$	—	165	275	
	—	—	<b>350</b>			
		$I_{OUT} = 300mA$	—	250	400	
			—	—	<b>500</b>	
		$I_{OUT} = 500mA$	—	350	600	
			—	—	<b>700</b>	
$I_{STD}$	Standby Current	$V_{EN} \leq 0.4V$ (Shutdown)	—	0.01	1	$\mu A$
		$V_{EN} \leq 0.18V$ (Shutdown)	—	—	<b>5</b>	
$I_{GND}$	Ground Pin Current (Note 10)	$V_{EN} \geq 2.0V$ , $I_{OUT} = 100\mu A$	—	100	150	$\mu A$
			—	—	<b>180</b>	
		$V_{EN} \geq 2.0V$ , $I_{OUT} = 50mA$	—	350	600	$\mu A$
			—	—	<b>800</b>	
		$V_{EN} \geq 2.0V$ , $I_{OUT} = 150mA$	—	1.3	1.9	mA
			—	—	<b>2.5</b>	
$V_{EN} \geq 2.0V$ , $I_{OUT} = 300mA$	—	4	10	mA		
	—	—	<b>15</b>			
$V_{EN} \geq 2.0V$ , $I_{OUT} = 500mA$	—	11	20	mA		
	—	—	<b>28</b>			



**AP2213-2.5 Electrical Characteristics** (cont.) (@ $V_{IN} = 3.5V$ ,  $I_{OUT} = 100\mu A$ ,  $C_{IN} = 1.0\mu F$ ,  $C_{OUT} = 2.2\mu F$ ,  $V_{EN} \geq 2.0V$ ,  $T_J = +25^\circ C$ , **Bold** typeface applies over  $-40^\circ C \leq T_J \leq +125^\circ C$  (Note 6), unless otherwise specified.)

Symbol	Parameter	Conditions	Min	Typ	Max	Unit
PSRR	Ripple Rejection	$f = 100Hz$ , $I_{OUT} = 100\mu A$	—	75	—	dB
$I_{LIMIT}$	Current Limit	$V_{OUT} = 0V$	—	<b>700</b>	1000	mA
$e_{no}$	Output Noise	$I_{OUT} = 50mA$ , $C_{OUT} = 2.2\mu F$ , 100pF from BYP to GND	—	260	—	$nV/\sqrt{Hz}$
$V_{IL}$	Enable Input Logic-Low Voltage	Regulator Shutdown	—	—	0.4	V
			—	—	<b>0.18</b>	
$V_{IH}$	Enable Input Logic-High Voltage	Regulator Enabled	<b>2.0</b>	—	—	V
$I_{IL}$	Enable Input Logic-Low Current	$V_{IL} \leq 0.4V$	—	0.01	1	$\mu A$
		$V_{IL} \leq 0.18V$	—	—	<b>2</b>	
$I_{IH}$	Enable Input Logic-High Current	$V_{IH} \geq 2.0V$	—	5	20	$\mu A$
		$V_{IH} \geq 2.0V$	—	—	<b>25</b>	
$\theta_{JC}$	Thermal Resistance	TO-252-2 (3)	—	20	—	$^\circ C/W$
		SOIC-8	—	45	—	
		SOT-223	—	31	—	

- Notes:
- Specifications in bold type are limited to  $-40^\circ C \leq T_J \leq +125^\circ C$ . Limits over temperature are guaranteed by design, but not tested in production.
  - Output voltage temperature coefficient is defined as the worst case voltage change divided by the total temperature range.
  - Regulation is measured at constant junction temperature using low duty cycle pulse testing. Parts are tested for load regulation in the load range from 0.1mA to 500mA. Changes in output voltage due to heating effects are covered by the thermal regulation specification.
  - Dropout voltage is defined as the input to output differential at which the output voltage drops 1% ( $T_J = +25^\circ C$ ) or 2% ( $-40^\circ C \leq T_J \leq +125^\circ C$ ) below its nominal value measured at 1V differential.
  - Ground pin current is the regulator quiescent current plus pass transistor base current. The total current drawn from the supply is the sum of the load current plus the ground pin current.



**AP2213-3.0 Electrical Characteristics** (@ $V_{IN} = 4V$ ,  $I_{OUT} = 100\mu A$ ,  $C_{IN} = 1.0\mu F$ ,  $C_{OUT} = 2.2\mu F$ ,  $V_{EN} \geq 2.0V$ ,  $T_J = +25^\circ C$ , **Bold** typeface applies over  $-40^\circ C \leq T_J \leq +125^\circ C$  (Note 6), unless otherwise specified.)

Symbol	Parameter	Conditions	Min	Typ	Max	Unit
$\Delta V_{OUT}/V_{OUT}$	Output Voltage Accuracy	Variation from Specified $V_{OUT}$	-1	—	1	%
			<b>-2</b>	—	<b>2</b>	
$\Delta V_{OUT}/\Delta T$	Output Voltage Temperature Coefficient (Note 7)	—	—	<b>120</b>	—	$\mu V/^\circ C$
$(\Delta V_{OUT}/V_{OUT})/\Delta T$			—	<b>40</b>	—	ppm/ $^\circ C$
$V_{RLINE}$	Line Regulation	$V_{IN} = 4V$ to 13.2V	—	1.5	4.5	mV
			—	—	<b>12</b>	
$V_{RLOAD}$	Load Regulation (Note 8)	$I_{OUT} = 0.1mA$ to 500mA	—	1	8	mV
			—	—	<b>17</b>	
$V_{DROP}$	Dropout Voltage (Note 9)	$I_{OUT} = 100\mu A$	—	15	50	mV
			—	—	<b>70</b>	
		$I_{OUT} = 50mA$	—	110	150	
			—	—	<b>230</b>	
		$I_{OUT} = 100mA$	—	140	250	
			—	—	<b>300</b>	
		$I_{OUT} = 150mA$	—	165	275	
	—	—	<b>350</b>			
$I_{STD}$	Standby Current	$V_{EN} \leq 0.4V$ (Shutdown)	—	0.01	1	$\mu A$
		$V_{EN} \leq 0.18V$ (Shutdown)	—	—	<b>5</b>	
$I_{GND}$	Ground Pin Current (Note 10)	$V_{EN} \geq 2.0V$ , $I_{OUT} = 100\mu A$	—	100	150	$\mu A$
			—	—	<b>180</b>	
		$V_{EN} \geq 2.0V$ , $I_{OUT} = 50mA$	—	350	600	mA
			—	—	<b>800</b>	
		$V_{EN} \geq 2.0V$ , $I_{OUT} = 150mA$	—	1.3	1.9	
			—	—	<b>2.5</b>	
	$V_{EN} \geq 2.0V$ , $I_{OUT} = 300mA$	—	4	10		
		—	—	<b>15</b>		
	$V_{EN} \geq 2.0V$ , $I_{OUT} = 500mA$	—	11	20		
		—	—	<b>28</b>		





**AP2213-3.0 Electrical Characteristics** (cont.) (@ $V_{IN} = 4V$ ,  $I_{OUT} = 100\mu A$ ,  $C_{IN} = 1.0\mu F$ ,  $C_{OUT} = 2.2\mu F$ ,  $V_{EN} \geq 2.0V$ ,  $T_J = +25^\circ C$ , **Bold** typeface applies over  $-40^\circ C \leq T_J \leq +125^\circ C$  (Note 6), unless otherwise specified.)

Symbol	Parameter	Conditions	Min	Typ	Max	Unit
PSRR	Ripple Rejection	$f = 100Hz$ , $I_{OUT} = 100\mu A$	—	75	—	dB
$I_{LIMIT}$	Current Limit	$V_{OUT} = 0V$	—	<b>700</b>	1000	mA
$e_{no}$	Output Noise	$I_{OUT} = 50mA$ , $C_{OUT} = 2.2\mu F$ , 100pF from BYP to GND	—	260	—	$nV/\sqrt{Hz}$
$V_{IL}$	Enable Input Logic-Low Voltage	Regulator Shutdown	—	—	0.4	V
			—	—	<b>0.18</b>	
$V_{IH}$	Enable Input Logic-High Voltage	Regulator Enabled	<b>2.0</b>	—	—	V
$I_{IL}$	Enable Input Logic-Low Current	$V_{IL} \leq 0.4V$	—	0.01	1	$\mu A$
		$V_{IL} \leq 0.18V$	—	—	<b>2</b>	
$I_{IH}$	Enable Input Logic-High Current	$V_{IH} \geq 2.0V$	—	5	20	$\mu A$
		$V_{IH} \geq 2.0V$	—	—	<b>25</b>	
$\theta_{JC}$	Thermal Resistance	TO-252-2 (3)	—	20	—	$^\circ C/W$
		SOIC-8	—	45	—	
		SOT-223	—	31	—	

- Notes:
- Specifications in bold type are limited to  $-40^\circ C \leq T_J \leq +125^\circ C$ . Limits over temperature are guaranteed by design, but not tested in production.
  - Output voltage temperature coefficient is defined as the worst case voltage change divided by the total temperature range.
  - Regulation is measured at constant junction temperature using low duty cycle pulse testing. Parts are tested for load regulation in the load range from 0.1mA to 500mA. Changes in output voltage due to heating effects are covered by the thermal regulation specification.
  - Dropout voltage is defined as the input to output differential at which the output voltage drops 1% ( $T_J = +25^\circ C$ ) or 2% ( $-40^\circ C \leq T_J \leq +125^\circ C$ ) below its nominal value measured at 1V differential.
  - Ground pin current is the regulator quiescent current plus pass transistor base current. The total current drawn from the supply is the sum of the load current plus the ground pin current.



**AP2213-3.3 Electrical Characteristics** (@ $V_{IN} = 4.3V$ ,  $I_{OUT} = 100\mu A$ ,  $C_{IN} = 1.0\mu F$ ,  $C_{OUT} = 2.2\mu F$ ,  $V_{EN} \geq 2.0V$ ,  $T_J = +25^\circ C$ , **Bold** typeface applies over  $-40^\circ C \leq T_J \leq +125^\circ C$  (Note 6), unless otherwise specified.)

Symbol	Parameter	Conditions	Min	Typ	Max	Unit
$\Delta V_{OUT}/V_{OUT}$	Output Voltage Accuracy	Variation from Specified $V_{OUT}$	-1	—	1	%
			<b>-2</b>	—	<b>2</b>	
$\Delta V_{OUT}/\Delta T$	Output Voltage Temperature Coefficient (Note 7)	—	—	<b>120</b>	—	$\mu V/^\circ C$
$(\Delta V_{OUT}/V_{OUT})/\Delta T$			—	<b>36.3</b>	—	ppm/ $^\circ C$
$V_{RLINE}$	Line Regulation	$V_{IN} = 4.3V$ to $13.2V$	—	1.5	4.5	mV
			—	—	<b>12</b>	
$V_{RLOAD}$	Load Regulation (Note 8)	$I_{OUT} = 0.1mA$ to $500mA$	—	1	9	mV
			—	—	<b>18</b>	
$V_{DROP}$	Dropout Voltage (Note 9)	$I_{OUT} = 100\mu A$	—	15	50	mV
			—	—	<b>70</b>	
		$I_{OUT} = 50mA$	—	110	150	
			—	—	<b>230</b>	
		$I_{OUT} = 100mA$	—	140	250	
			—	—	<b>300</b>	
		$I_{OUT} = 150mA$	—	165	275	
	—	—	<b>350</b>			
	$I_{OUT} = 300mA$	—	250	400		
		—	—	<b>500</b>		
	$I_{OUT} = 500mA$	—	350	600		
		—	—	<b>700</b>		
$I_{STD}$	Standby Current	$V_{EN} \leq 0.4V$ (Shutdown)	—	0.01	1	$\mu A$
		$V_{EN} \leq 0.18V$ (Shutdown)	—	—	<b>5</b>	
$I_{GND}$	Ground Pin Current (Note 10)	$V_{EN} \geq 2.0V$ , $I_{OUT} = 100\mu A$	—	100	150	$\mu A$
			—	—	<b>180</b>	
		$V_{EN} \geq 2.0V$ , $I_{OUT} = 50mA$	—	350	600	$\mu A$
			—	—	<b>800</b>	
		$V_{EN} \geq 2.0V$ , $I_{OUT} = 150mA$	—	1.3	1.9	mA
			—	—	<b>2.5</b>	
$V_{EN} \geq 2.0V$ , $I_{OUT} = 300mA$	—	4	10	mA		
	—	—	<b>15</b>			
$V_{EN} \geq 2.0V$ , $I_{OUT} = 500mA$	—	11	20	mA		
	—	—	<b>28</b>			

**AP2213-3.3 Electrical Characteristics** (cont.) (@ $V_{IN} = 4.3V$ ,  $I_{OUT} = 100\mu A$ ,  $C_{IN} = 1.0\mu F$ ,  $C_{OUT} = 2.2\mu F$ ,  $V_{EN} \geq 2.0V$ ,  $T_J = +25^\circ C$ , **Bold** typeface applies over  $-40^\circ C \leq T_J \leq +125^\circ C$  (Note 6), unless otherwise specified.)

Symbol	Parameter	Conditions	Min	Typ	Max	Unit
PSRR	Ripple Rejection	$f = 100Hz$ , $I_{OUT} = 100\mu A$	—	75	—	dB
$I_{LIMIT}$	Current Limit	$V_{OUT} = 0V$	—	<b>700</b>	1000	mA
$e_{no}$	Output Noise	$I_{OUT} = 50mA$ , $C_{OUT} = 2.2\mu F$ , 100pF from BYP to GND	—	260	—	$nV/\sqrt{Hz}$
$V_{IL}$	Enable Input Logic-Low Voltage	Regulator Shutdown	—	—	0.4	V
			—	—	<b>0.18</b>	
$V_{IH}$	Enable Input Logic-High Voltage	Regulator Enabled	<b>2.0</b>	—	—	V
$I_{IL}$	Enable Input Logic-Low Current	$V_{IL} \leq 0.4V$	—	0.01	1	$\mu A$
		$V_{IL} \leq 0.18V$	—	—	<b>2</b>	
$I_{IH}$	Enable Input Logic-High Current	$V_{IH} \geq 2.0V$	—	5	20	$\mu A$
		$V_{IH} \geq 2.0V$	—	—	<b>25</b>	
$\theta_{JC}$	Thermal Resistance	TO-252-2 (3)	—	20	—	$^\circ C/W$
		SOIC-8	—	45	—	
		SOT-223	—	31	—	

- Notes:
- Specifications in bold type are limited to  $-40^\circ C \leq T_J \leq +125^\circ C$ . Limits over temperature are guaranteed by design, but not tested in production.
  - Output voltage temperature coefficient is defined as the worst case voltage change divided by the total temperature range.
  - Regulation is measured at constant junction temperature using low duty cycle pulse testing. Parts are tested for load regulation in the load range from 0.1mA to 500mA. Changes in output voltage due to heating effects are covered by the thermal regulation specification.
  - Dropout voltage is defined as the input to output differential at which the output voltage drops 1% ( $T_J = +25^\circ C$ ) or 2% ( $-40^\circ C \leq T_J \leq +125^\circ C$ ) below its nominal value measured at 1V differential.
  - Ground pin current is the regulator quiescent current plus pass transistor base current. The total current drawn from the supply is the sum of the load current plus the ground pin current.



Performance Characteristics

Output Voltage vs. Junction Temperature

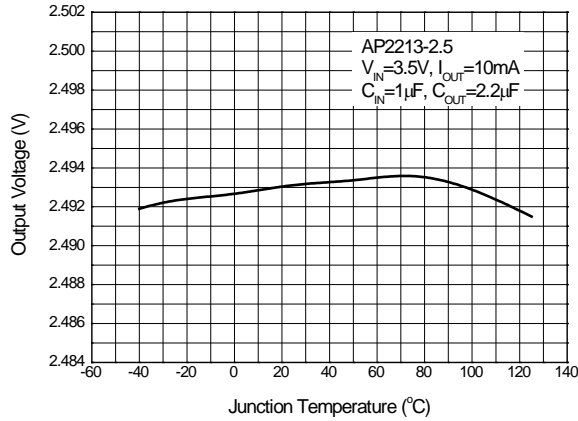

Dropout Voltage vs. Junction Temperature

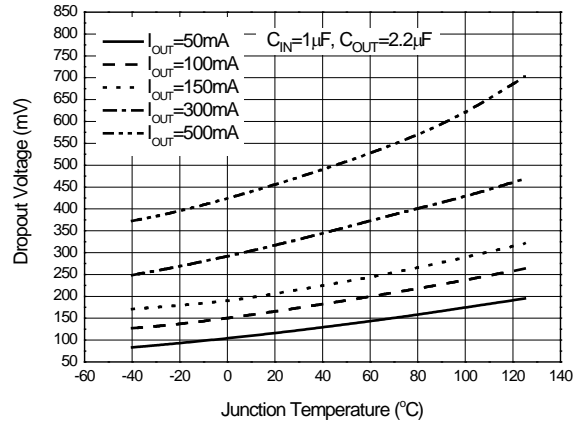

Ground Pin Current vs. Output Current

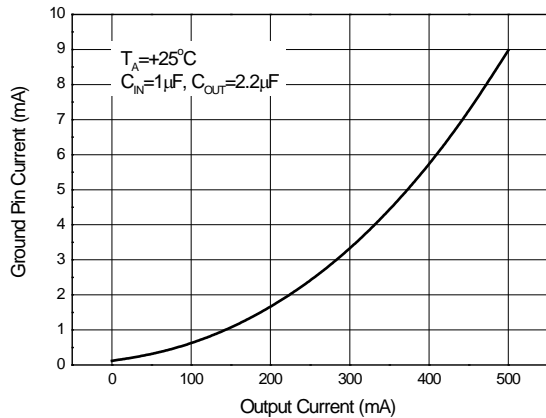

Ground Pin Current vs. Junction Temperature

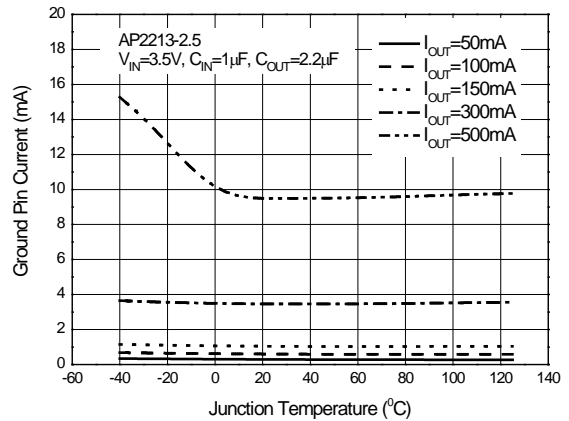

Enable Current vs. Junction Temperature

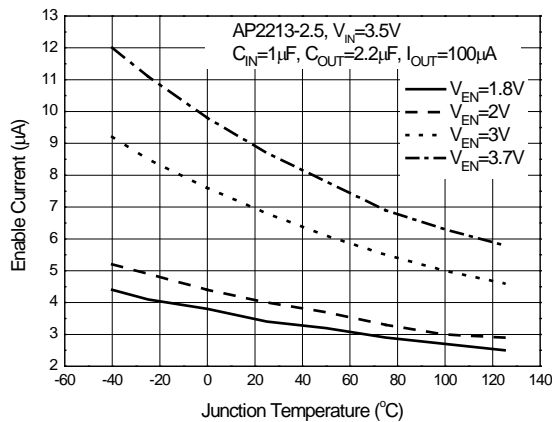

Enable Voltage vs. Junction Temperature

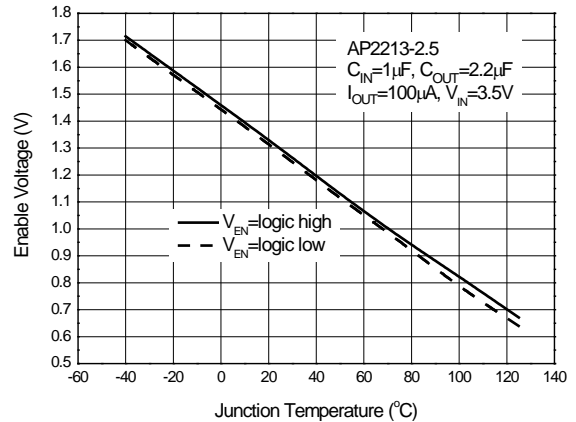



**Performance Characteristics (cont.)**

**Output Noise vs. Frequency**

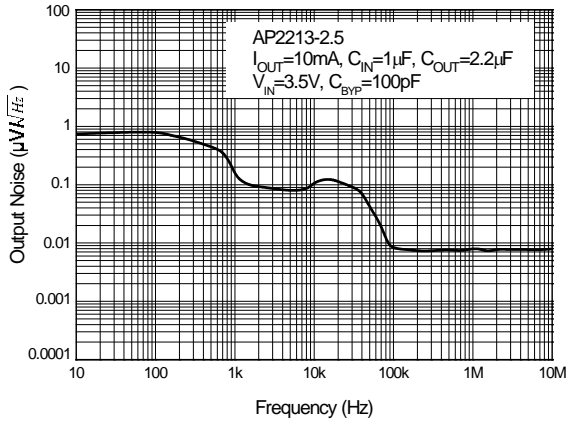

**Line Transient**  
(Conditions:  $V_{IN}=3.4V$  to  $4.4V$ ,  $V_{EN}=2V$ ,  $I_{OUT}=100\mu A$ ,  $C_{BYP}=100pF$ ,  $C_{OUT}=2.2\mu F$ )

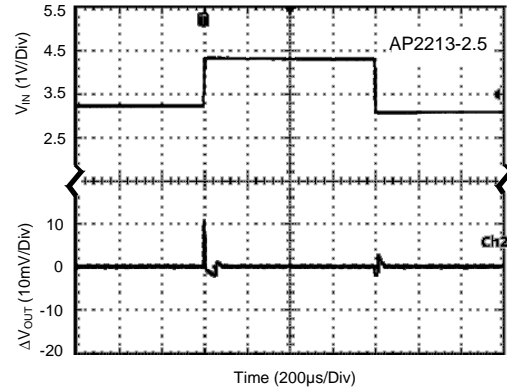

**Load Transient**  
(Conditions:  $V_{IN}=3.5V$ ,  $C_{BYP}=100pF$ ,  $V_{EN}=2V$ ,  $I_{OUT}=10mA$  to  $500mA$ ,  $C_{IN}=1.0\mu F$ ,  $C_{OUT}=2.2\mu F$ )

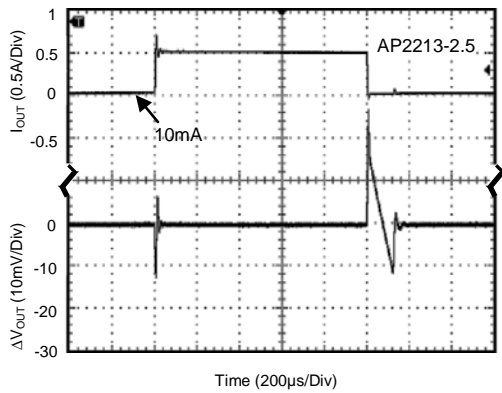

**VEN vs. VOUT**  
(Conditions:  $V_{EN}=0V$  to  $2V$ ,  $V_{IN}=3.5V$ ,  $I_{OUT}=30mA$ ,  $C_{BYP}=open$ ,  $C_{IN}=1.0\mu F$ ,  $C_{OUT}=2.2\mu F$ )

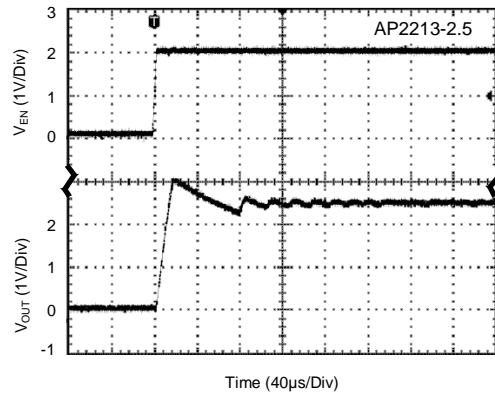

**PSRR vs. Frequency**

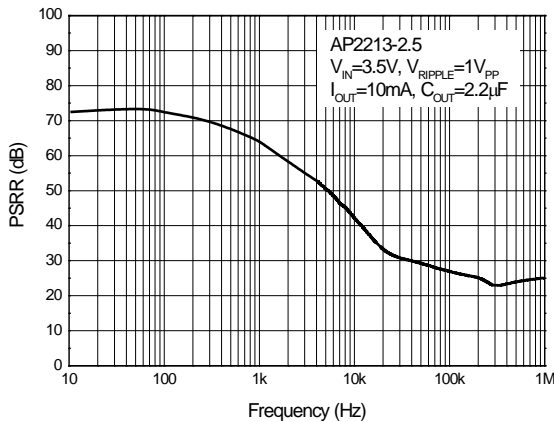

**Power Dissipation vs. Ambient Temperature**

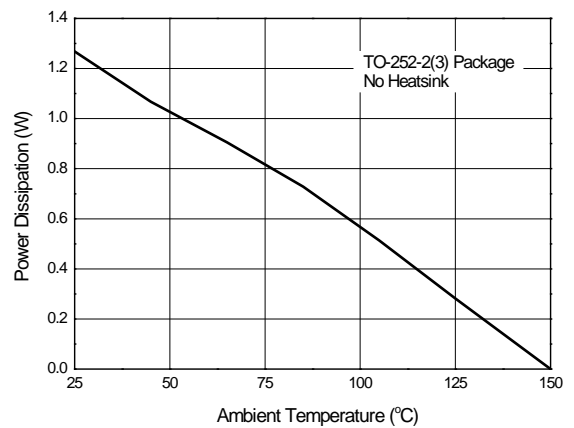



**Performance Characteristics** (cont.)

**Power Dissipation vs. Ambient Temperature**

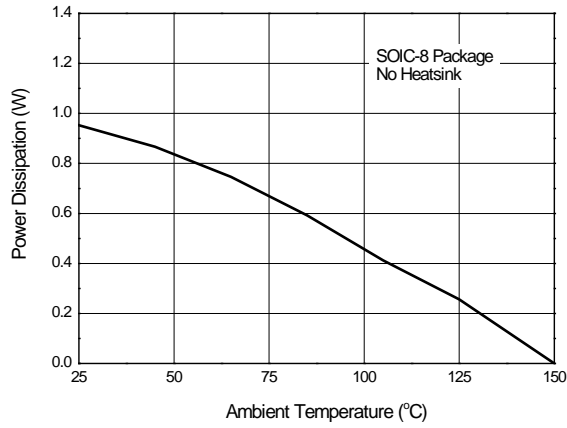

**ESR vs. Output Current**

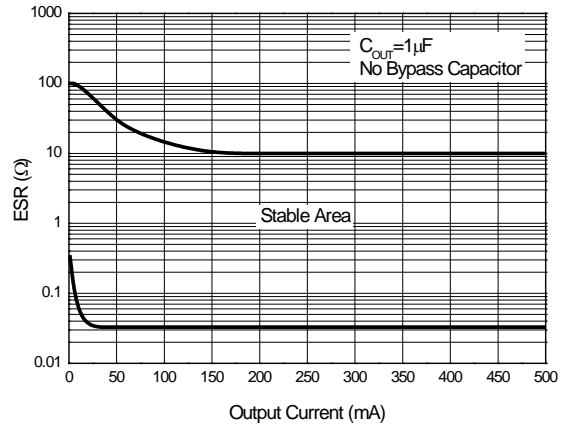

**ESR vs. Output Current**

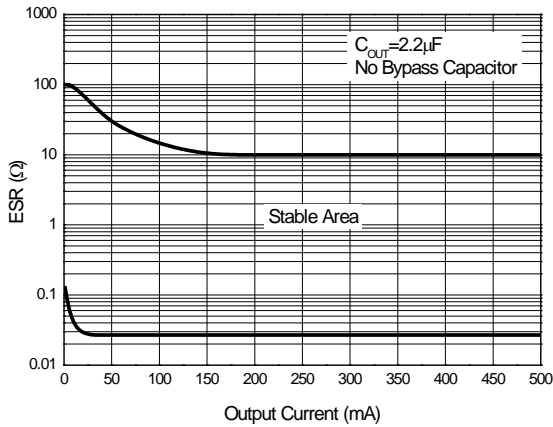

**ESR vs. Output Current**

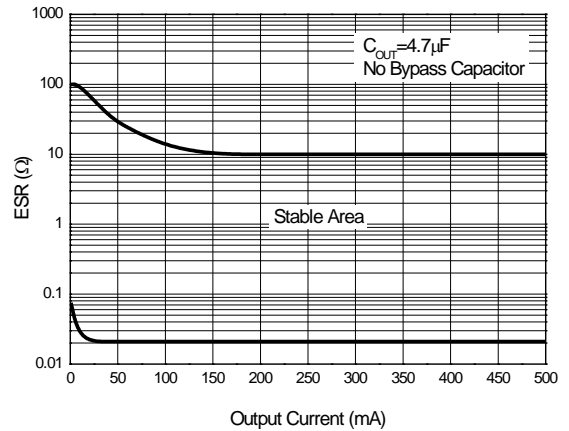



## Application Information

### Input Capacitor

A 1 $\mu$ F minimum capacitor is recommended to be placed between  $V_{IN}$  and GND.

### Output Capacitor

An output capacitor is required to prevent oscillation. A 1 $\mu$ F minimum is recommended when  $C_{BYP}$  is unused. A 2.2 $\mu$ F minimum is recommended when  $C_{BYP}$  is 100pF. The output capacitor may be increased to improve transient response.

### Noise Bypass Capacitor

A bypass capacitor is connected to the internal voltage reference. A small capacitor connected from BYP to GND makes this reference quiet, resulting in a significant reduction in output noise, but the ESR stable area will be narrowed. In order to keep the output stability, it is recommended to use the bypass capacitor no more than 100pF.

The start-up speed of the AP2213 is inversely proportional to the value of the reference bypass capacitor. In some cases, if output noise is not a major concern and rapid turn-on is necessary, omit  $C_{BYP}$  and leave BYP open.

### Power Dissipation

Thermal shutdown may take place if the maximum power dissipation is exceeded in application. Under all possible operating conditions, the junction temperature must be within the range specified under absolute maximum ratings to avoid thermal shutdown.

To determine if the power dissipated in the regulator reaches the maximum power dissipation (see Figure Power Dissipation vs. Ambient Temperature (SOIC-8 Package), ESR vs. Output Current ( $C_{OUT} = 1\mu$ F)), use:

$$T_J = P_D \cdot \theta_{JA} + T_A$$

$$P_D = (V_{IN} - V_{OUT}) \cdot I_{OUT} + V_{IN} \cdot I_{GND}$$

Where:  $T_J \leq T_{J(max)}$ ,  $T_{J(max)}$  is absolute maximum ratings for the junction temperature;  $V_{IN} \cdot I_{GND}$  can be ignored due to its small value.

$T_{J(max)}$  is +150°C,  $\theta_{JA}$  is 90°C/W for TO-252-2 (3) package and 160°C/W for SOIC-8 package.





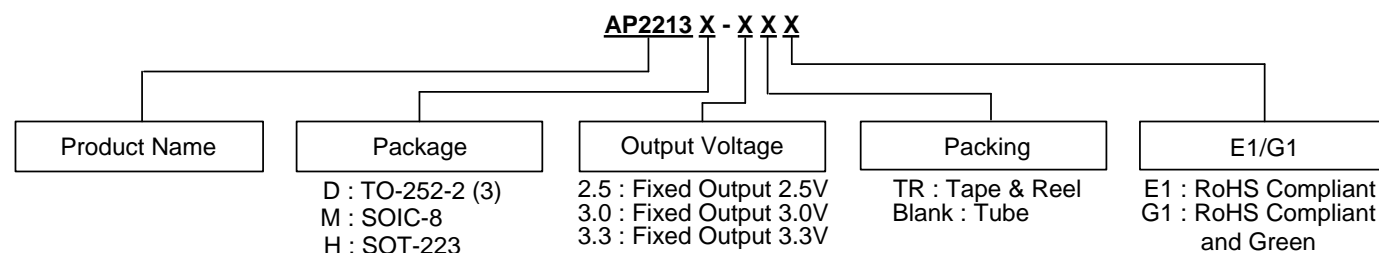

Example: For 2.5V version packaged in SOIC-8,  $I_{OUT} = 500$ mA,  $T_A = +50^\circ$ C,  $V_{IN(Max)}$  is:

$$(150^\circ\text{C} - 50^\circ\text{C}) / (0.5\text{A} \cdot 160^\circ\text{C/W}) + 2.5\text{V} = 3.75\text{V}$$

Therefore, for good performance, please make sure that the input voltage is less than 3.75V without heatsink when  $T_A = +50^\circ$ C.

## Ordering Information



Package	Temperature Range	Part Number		Marking ID		Packing
		RoHS Compliant	RoHS Compliant and Green	RoHS Compliant	RoHS Compliant and Green	
 Lead-Free  Lead-Free Green	TO-252-2 (3) -40 to +125°C	AP2213D-2.5E1	AP2213D-2.5G1	AP2213D-2.5E1	AP2213D-2.5G1	100/Tube
		AP2213D-2.5TRE1	AP2213D-2.5TRG1	AP2213D-2.5E1	AP2213D-2.5G1	2500/Tape & Reel
		AP2213D-3.0E1	AP2213D-3.0G1	AP2213D-3.0E1	AP2213D-3.0G1	100/Tube
		AP2213D-3.0TRE1	AP2213D-3.0TRG1	AP2213D-3.0E1	AP2213D-3.0G1	2500/Tape & Reel
		AP2213D-3.3E1	AP2213D-3.3G1	AP2213D-3.3E1	AP2213D-3.3G1	100/Tube
		AP2213D-3.3TRE1	AP2213D-3.3TRG1	AP2213D-3.3E1	AP2213D-3.3G1	2500/Tape & Reel
 Lead-Free  Lead-Free Green	SOIC-8 -40 to +125°C	AP2213M-2.5E1	AP2213M-2.5G1	2213M-2.5E1	2213M-2.5G1	100/Tube
		AP2213M-2.5TRE1	AP2213M-2.5TRG1	2213M-2.5E1	2213M-2.5G1	2500/Tape & Reel
		AP2213M-3.0E1	AP2213M-3.0G1	2213M-3.0E1	2213M-3.0G1	100/Tube
		AP2213M-3.0TRE1	AP2213M-3.0TRG1	2213M-3.0E1	2213M-3.0G1	2500/Tape & Reel
		AP2213M-3.3E1	AP2213M-3.3G1	2213M-3.3E1	2213M-3.3G1	100/Tube
		AP2213M-3.3TRE1	AP2213M-3.3TRG1	2213M-3.3E1	2213M-3.3G1	2500/Tape & Reel
 Lead-Free  Lead-Free Green	SOT-223 -40 to +125°C	AP2213H-2.5TRE1	AP2213H-2.5TRG1	EH13C	GH13C	4000/Tape & Reel
		AP2213H-3.0TRE1	AP2213H-3.0TRG1	EH13E	GH13E	4000/Tape & Reel
		AP2213H-3.3TRE1	AP2213H-3.3TRG1	EH13F	GH13F	4000/Tape & Reel



## Marking Information

### (1) TO-252-2 (3)

(Top View)

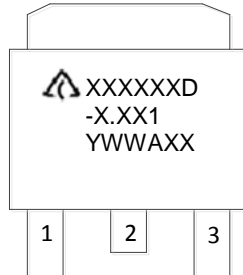

First and Second Lines: Logo and Marking ID  
(See Ordering Information)  
Third Line: Date Code  
Y: Year  
WW: Work Week of Molding  
A: Assembly House Code  
XX: 7<sup>th</sup> and 8<sup>th</sup> Digits of Batch Number

### (2) SOIC-8

(Top View)

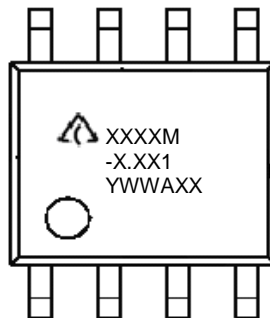

First and Second Lines: Logo and Marking ID  
(See Ordering Information)  
Third line: Date Code  
Y: Year  
WW: Work Week of Molding  
A: Assembly House Code  
XX: 7<sup>th</sup> and 8<sup>th</sup> Digits of Batch Number

### (3) SOT-223

(Top View)

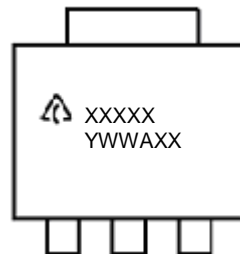

First Line: Logo and Marking ID  
(See Ordering Information)  
Second Line: Date Code  
Y: Year  
WW: Work Week of Molding  
A: Assembly House Code  
XX: 7<sup>th</sup> and 8<sup>th</sup> Digits of Batch Number



AP2213

**Package Outline Dimensions** (All dimensions in mm(inch).)

(1) Package Type: TO-252-2 (3)

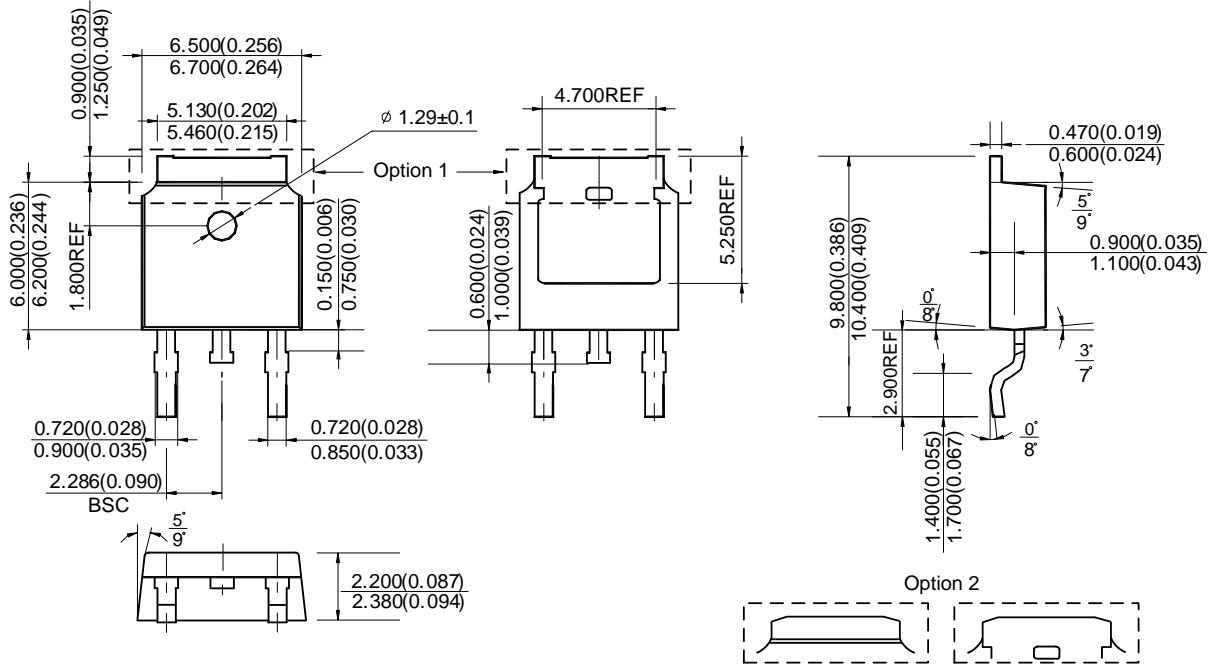

**Package Outline Dimensions** (All dimensions in mm(inch).) (continued)

(2) Package Type: SOIC-8

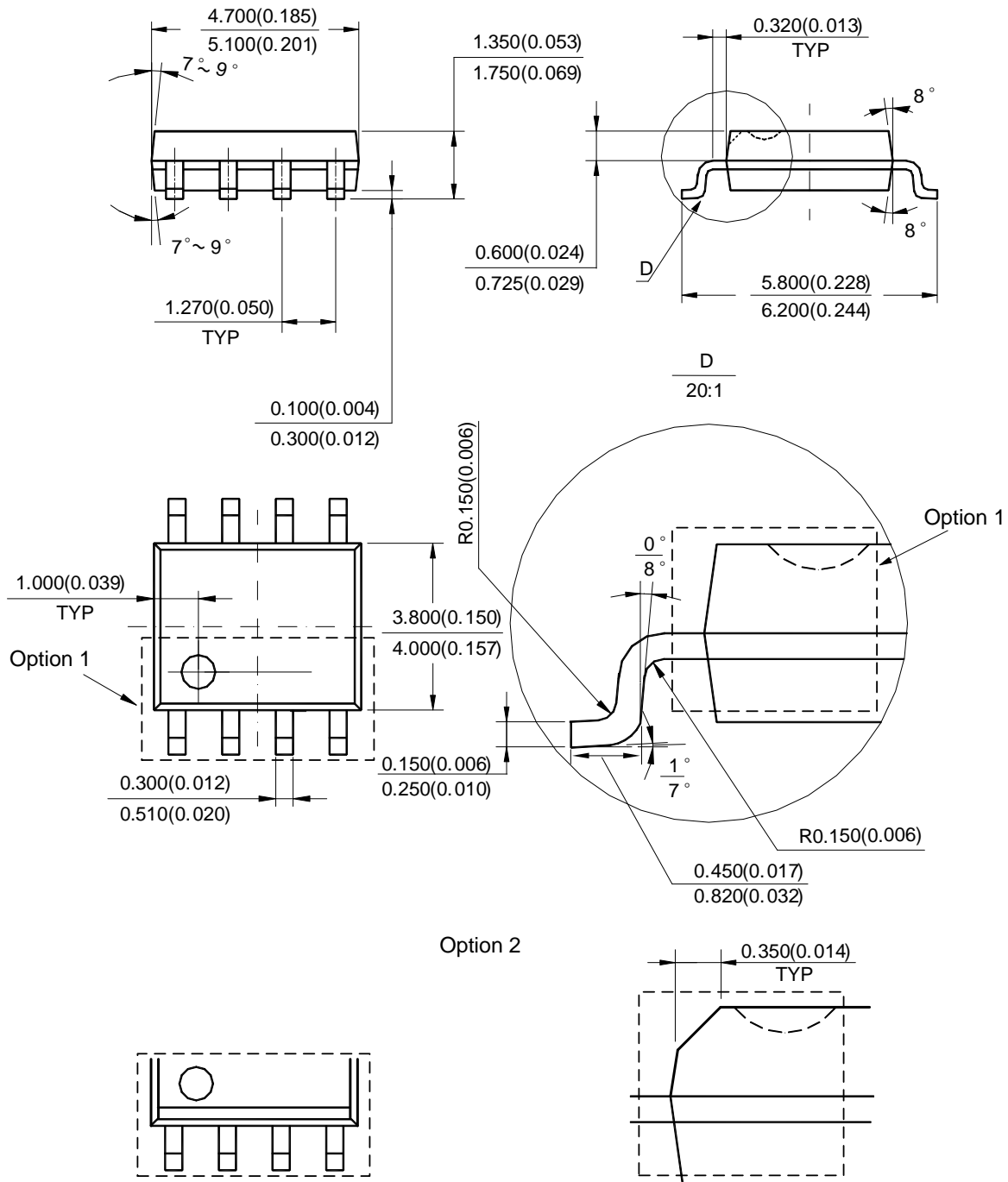

Note: Eject hole, oriented hole and mold mark is optional.



AP2213

### Package Outline Dimensions (All dimensions in mm(inch.)) (continued)

(3) Package Type: SOT-223

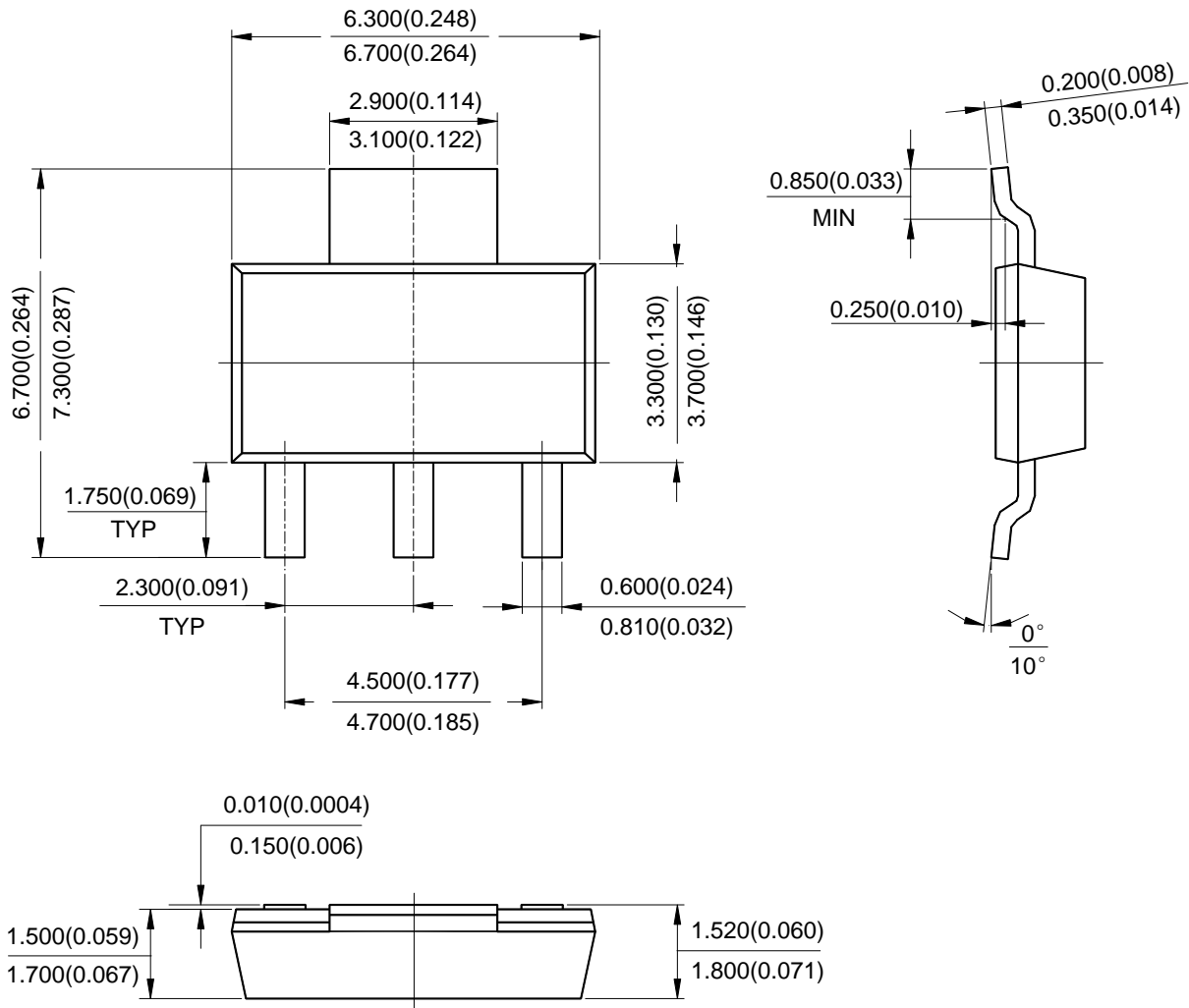

## Suggested Pad Layout

(1) Package Type: TO-252-2 (3)

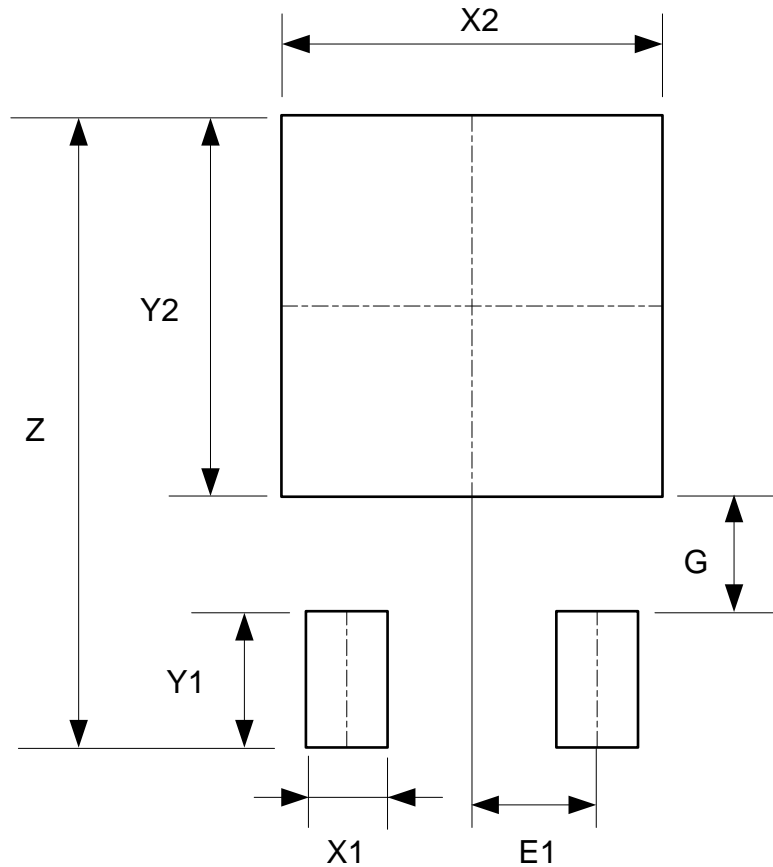

Dimensions	Z (mm)/(inch)	X1 (mm)/(inch)	X2=Y2 (mm)/(inch)	Y1 (mm)/(inch)	G (mm)/(inch)	E1 (mm)/(inch)
Value	11.600/0.457	1.500/0.059	7.000/0.276	2.500/0.098	2.100/0.083	2.300/0.091

## Suggested Pad Layout (continued)

(2) Package Type: SOIC-8

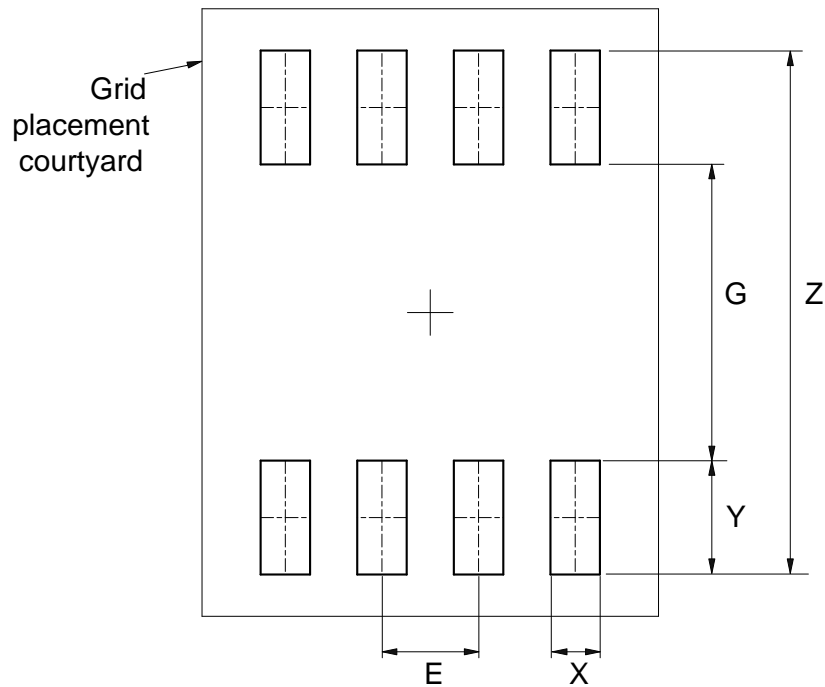

Dimensions	Z (mm)/(inch)	G (mm)/(inch)	X (mm)/(inch)	Y (mm)/(inch)	E (mm)/(inch)
Value	6.900/0.272	3.900/0.154	0.650/0.026	1.500/0.059	1.270/0.050

---

**Suggested Pad Layout** (continued)
 

---

(3) Package Type: SOT-223

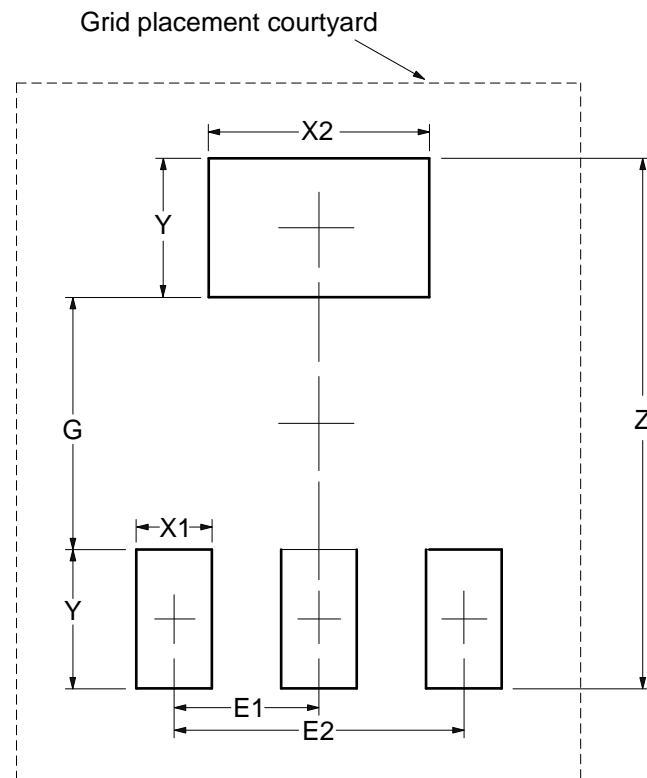

Dimensions	Z (mm)/(inch)	G (mm)/(inch)	X1 (mm)/(inch)	X2 (mm)/(inch)	Y (mm)/(inch)	E1 (mm)/(inch)	E2 (mm)/(inch)
Value	8.400/0.331	4.000/0.157	1.200/0.047	3.500/0.138	2.200/0.087	2.300/0.091	4.600/0.181



#### IMPORTANT NOTICE

DIODES INCORPORATED MAKES NO WARRANTY OF ANY KIND, EXPRESS OR IMPLIED, WITH REGARDS TO THIS DOCUMENT, INCLUDING, BUT NOT LIMITED TO, THE IMPLIED WARRANTIES OF MERCHANTABILITY AND FITNESS FOR A PARTICULAR PURPOSE (AND THEIR EQUIVALENTS UNDER THE LAWS OF ANY JURISDICTION).

Diodes Incorporated and its subsidiaries reserve the right to make modifications, enhancements, improvements, corrections or other changes without further notice to this document and any product described herein. Diodes Incorporated does not assume any liability arising out of the application or use of this document or any product described herein; neither does Diodes Incorporated convey any license under its patent or trademark rights, nor the rights of others. Any Customer or user of this document or products described herein in such applications shall assume all risks of such use and will agree to hold Diodes Incorporated and all the companies whose products are represented on Diodes Incorporated website, harmless against all damages.

Diodes Incorporated does not warrant or accept any liability whatsoever in respect of any products purchased through unauthorized sales channel. Should Customers purchase or use Diodes Incorporated products for any unintended or unauthorized application, Customers shall indemnify and hold Diodes Incorporated and its representatives harmless against all claims, damages, expenses, and attorney fees arising out of, directly or indirectly, any claim of personal injury or death associated with such unintended or unauthorized application.

Products described herein may be covered by one or more United States, international or foreign patents pending. Product names and markings noted herein may also be covered by one or more United States, international or foreign trademarks.

This document is written in English but may be translated into multiple languages for reference. Only the English version of this document is the final and determinative format released by Diodes Incorporated.

#### LIFE SUPPORT

Diodes Incorporated products are specifically not authorized for use as critical components in life support devices or systems without the express written approval of the Chief Executive Officer of Diodes Incorporated. As used herein:

A. Life support devices or systems are devices or systems which:

1. are intended to implant into the body, or
2. support or sustain life and whose failure to perform when properly used in accordance with instructions for use provided in the labeling can be reasonably expected to result in significant injury to the user.

B. A critical component is any component in a life support device or system whose failure to perform can be reasonably expected to cause the failure of the life support device or to affect its safety or effectiveness.

Customers represent that they have all necessary expertise in the safety and regulatory ramifications of their life support devices or systems, and acknowledge and agree that they are solely responsible for all legal, regulatory and safety-related requirements concerning their products and any use of Diodes Incorporated products in such safety-critical, life support devices or systems, notwithstanding any devices- or systems-related information or support that may be provided by Diodes Incorporated. Further, Customers must fully indemnify Diodes Incorporated and its representatives against any damages arising out of the use of Diodes Incorporated products in such safety-critical, life support devices or systems.

Copyright © 2020, Diodes Incorporated

[www.diodes.com](http://www.diodes.com)



## OUR CERTIFICATE

DiGi provide top-quality products and perfect service for customer worldwide through standardization, technological innovation and continuous improvement. DiGi through third-party certification, we stricly control the quality of products and services. Welcome your RFQ to

Email: [Info@DiGi-Electronics.com](mailto:Info@DiGi-Electronics.com)



Tel: +00 852-30501935

RFQ Email: [Info@DiGi-Electronics.com](mailto:Info@DiGi-Electronics.com)

DiGi is a global authorized distributor of electronic components.