

# BC847C-13-F Datasheet



<https://www.DiGi-Electronics.com>

DiGi Electronics Part Number	BC847C-13-F-DG
Manufacturer	<a href="#">Diodes Incorporated</a>
Manufacturer Product Number	BC847C-13-F
Description	TRANS NPN 45V 0.1A SOT23-3
Detailed Description	Bipolar (BJT) Transistor NPN 45 V 100 mA 300MHz 3 10 mW Surface Mount SOT-23-3



Tel: +00 852-30501935

RFQ Email: [Info@DiGi-Electronics.com](mailto:Info@DiGi-Electronics.com)

DiGi is a global authorized distributor of electronic components.

## Purchase and inquiry

Manufacturer Product Number:

BC847C-13-F

Series:

-

Transistor Type:

NPN

Voltage - Collector Emitter Breakdown (Max):

45 V

Current - Collector Cutoff (Max):

15nA

Power - Max:

310 mW

Operating Temperature:

-65°C ~ 150°C (TJ)

Package / Case:

TO-236-3, SC-59, SOT-23-3

Base Product Number:

BC847

Manufacturer:

Diodes Incorporated

Product Status:

Active

Current - Collector (Ic) (Max):

100 mA

Vce Saturation (Max) @ Ib, Ic:

600mV @ 5mA, 100mA

DC Current Gain (hFE) (Min) @ Ic, Vce:

200 @ 2mA, 5V

Frequency - Transition:

300MHz

Mounting Type:

Surface Mount

Supplier Device Package:

SOT-23-3

## Environmental & Export classification

RoHS Status:

ROHS3 Compliant

REACH Status:

REACH Unaffected

HTSUS:

8541.21.0075

Moisture Sensitivity Level (MSL):

1 (Unlimited)

ECCN:

EAR99



## Features

- Ideally Suited for Automatic Insertion
- Complementary PNP Types: BC856–BC858
- For Switching and AF Amplifier Applications
- **Totally Lead-Free & Fully RoHS Compliant (Notes 1 & 2)**
- **Halogen and Antimony Free. "Green" Device (Note 3)**
- **An automotive-compliant part is available under separate datasheet ([BC846AQ-BC848CQ](#))**



SOT23

Top View

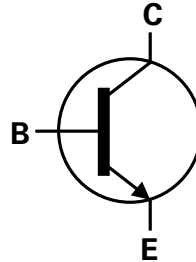

Device Symbol

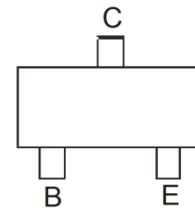
Top View  
Pin-Out

## Mechanical Data

- Package: SOT23
- Package Material: Molded Plastic, "Green" Molding Compound  
UL Flammability Classification Rating 94V-0
- Moisture Sensitivity: Level 1 per J-STD-020
- Terminals: Finish – Matte Tin Plated Leads, Solderable per MIL-STD-202, Method 208 (E3)
- Weight: 0.008 grams (Approximate)

## Ordering Information (Note 4)

Part Number	Package	Marking	Reel Size (inches)	Packing	
				Qty.	Carrier
BC846A-7-F	SOT23	K1Q	7	3,000	Reel
BC846B-7-F	SOT23	K1R	7	3,000	Reel
BC846B-13-F	SOT23	K1R	13	10,000	Reel
BC847A-7-F	SOT23	K1Q	7	3,000	Reel
BC847A-13-F	SOT23	K1Q	13	10,000	Reel
BC847B-7-F	SOT23	K1R	7	3,000	Reel
BC847B-13-F	SOT23	K1R	13	10,000	Reel
BC847C-7-F	SOT23	K1M	7	3,000	Reel
BC847C-13-F	SOT23	K1M	13	10,000	Reel
BC848A-7-F	SOT23	K1Q	7	3,000	Reel
BC848B-7-F	SOT23	K1R	7	3,000	Reel
BC848B-13-F	SOT23	K1R	13	10,000	Reel
BC848C-7-F	SOT23	K1M	7	3,000	Reel

- Notes:
1. No purposely added lead. Fully EU Directive 2002/95/EC (RoHS), 2011/65/EU (RoHS 2) & 2015/863/EU (RoHS 3) compliant.
  2. See <https://www.diodes.com/quality/lead-free/> for more information about Diodes Incorporated's definitions of Halogen- and Antimony-free, "Green" and Lead-free.
  3. Halogen- and Antimony-free "Green" products are defined as those which contain <900ppm bromine, <900ppm chlorine (<1500ppm total Br + Cl) and <1000ppm antimony compounds.
  4. For packaging details, go to our website at <https://www.diodes.com/design/support/packaging/diodes-packaging/>.

## Marking Information

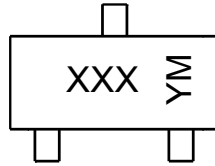

XXX = Product Type Marking Code  
 YM = Date Code Marking  
 Y or  $\bar{Y}$  = Year (ex: L = 2024)  
 M or  $\bar{M}$  = Month (ex: 9 = September)

### Date Code Key

Year	2007	-	2024	2025	2026	2027	2028	2029	2030	2031	2032	2033
Code	U	-	L	M	N	P	R	S	T	U	V	W

Month	Jan	Feb	Mar	Apr	May	Jun	Jul	Aug	Sep	Oct	Nov	Dec
Code	1	2	3	4	5	6	7	8	9	O	N	D

## Absolute Maximum Ratings (@T<sub>A</sub> = +25°C, unless otherwise specified.)

Characteristic	Symbol	Value	Unit	
Collector-Base Voltage	V <sub>CB0</sub>	BC846A/B	80	V
		BC847A/B/C	50	
		BC848A/B/C	30	
Collector-Emitter Voltage	V <sub>CEO</sub>	BC846A/B	65	V
		BC847A/B/C	45	
		BC848A/B/C	30	
Emitter-Base Voltage	V <sub>EB0</sub>	BC846A/B	6.0	V
		BC847A/B/C		
		BC848A/B/C	5.0	
Continuous Collector Current	I <sub>C</sub>	100	mA	
Peak Collector Current	I <sub>CM</sub>	200	mA	
Peak Emitter Current	I <sub>EM</sub>	200	mA	

## Thermal Characteristics (@T<sub>A</sub> = +25°C, unless otherwise specified.)

Characteristic	Symbol	Value	Unit	
Power Dissipation	P <sub>D</sub>	(Note 5)	310	mW
		(Note 6)	350	
Thermal Resistance, Junction to Ambient	R <sub>θJA</sub>	(Note 5)	403	°C/W
		(Note 6)	357	
Thermal Resistance, Junction to Leads	R <sub>θJL</sub>	350	°C/W	
Operating and Storage Temperature Range	T <sub>J</sub> , T <sub>STG</sub>	-65 to +150	°C	

## ESD Ratings (Note 8)

Characteristic	Symbol	Value	Unit	JEDEC Class
Electrostatic Discharge - Human Body Model	ESD HBM	4,000	V	3A
Electrostatic Discharge - Machine Model	ESD MM	400	V	C

- Notes:
- For a device mounted on minimum recommended pad layout 1oz copper that is on a single-sided FR4 PCB; device is measured under still air conditions whilst operating in a steady-state.
  - Same as Note 5, except the device is mounted on 15mm x 15mm 1oz copper.
  - Thermal resistance from junction to solder-point (at the end of the leads).
  - Refer to JEDEC specification JESD22-A114 and JESD22-A115.



BC846A-BC848C

**Thermal Characteristics and Derating Information**

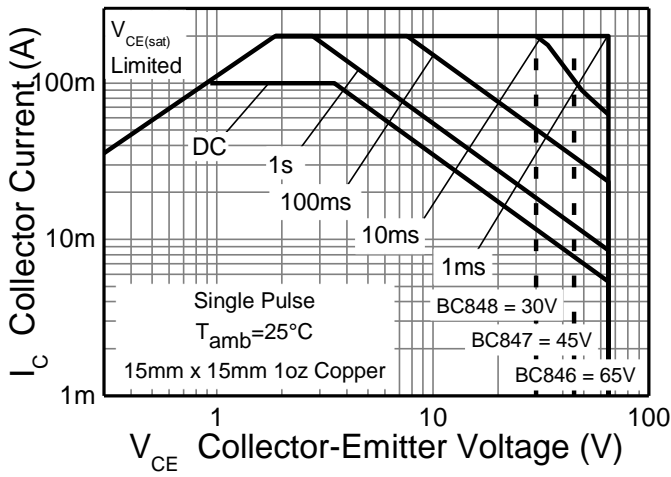

Figure 1. Safe Operating Area

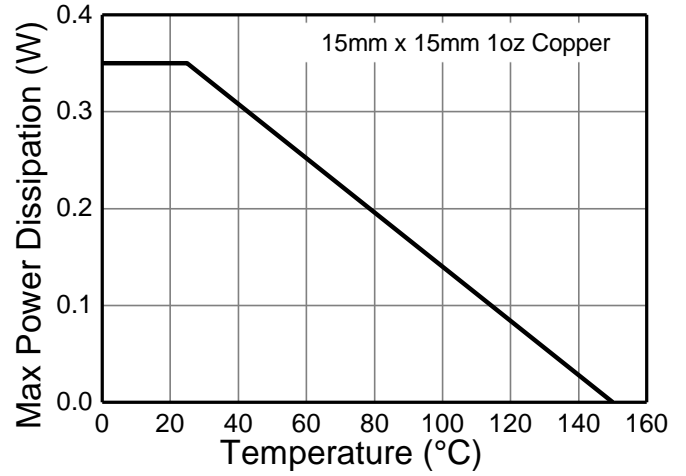

Figure 2. Derating Curve

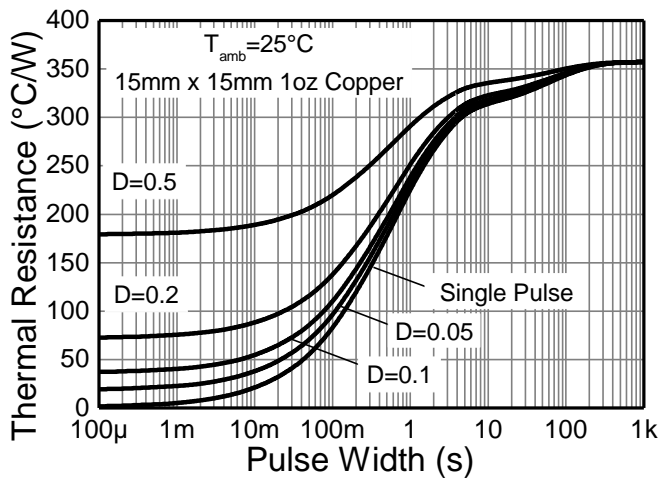

Figure 3. Transient Thermal Impedance

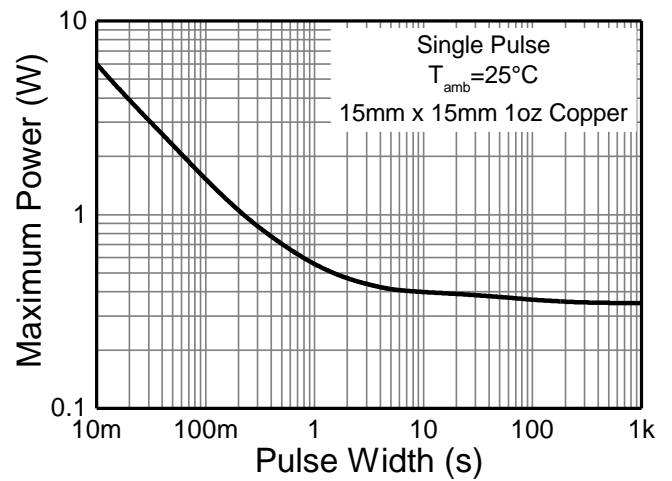

Figure 4. Pulse Power Dissipation

**Electrical Characteristics** (@T<sub>A</sub> = +25°C, unless otherwise specified.)

Characteristic		Symbol	Min	Typ	Max	Unit	Test Condition
Collector-Base Breakdown Voltage	BC846A/B	BV <sub>CBO</sub>	80	—	—	V	I <sub>C</sub> = 10μA
	BC847A/B/C		50				
	BC848A/B/C		30				
Collector-Emitter Breakdown Voltage (Note 9)	BC846A/B	BV <sub>CEO</sub>	65	—	—	V	I <sub>C</sub> = 10mA
	BC847A/B/C		45				
	BC848A/B/C		30				
Emitter-Base Breakdown Voltage	BC846A/B	BV <sub>EBO</sub>	6	—	—	V	I <sub>E</sub> = 1μA
	BC847A/B/C		5				
	BC848A/B/C						
Collector Cutoff Current		I <sub>CBO</sub>	—	—	15	nA	V <sub>CB</sub> = 30V
					5	μA	V <sub>CB</sub> = 30V, T <sub>J</sub> = +150°C
Collector Emitter Cutoff Current	BC846A/B	I <sub>CES</sub>	—	—	15	nA	V <sub>CE</sub> = 80V
	BC847A/B/C				15		V <sub>CE</sub> = 50V
	BC848A/B/C				15		V <sub>CE</sub> = 30V
Emitter Base Cutoff Current		I <sub>EBO</sub>	—	—	100	nA	V <sub>EB</sub> = 5V
Small Signal Current Gain (Note 9)	BC846A/BC847A/BC848A	h <sub>FE</sub>	—	200	—	—	I <sub>C</sub> = 2.0mA, V <sub>CE</sub> = 5V f = 1.0kHz
	BC846B/BC847B/BC848B			330			
	BC847C/BC848C			600			
Input Impedance (Note 9)	BC846A/BC847A/BC848A	h <sub>ie</sub>	—	2.7	—	kΩ	
	BC846B/BC847B/BC848B			4.5			
	BC847C/BC848C			8.7			
Output Admittance (Note 9)	BC846A/BC847A/BC848A	h <sub>oe</sub>	—	18	—	μS	
	BC846B/BC847B/BC848B			30			
	BC847C/BC848C			60			
Reverse Voltage Transfer Ratio (Note 9)	BC846A/BC847A/BC848A	h <sub>re</sub>	—	1.5 x 10 <sup>-4</sup>	—	—	
	BC846B/BC847B/BC848B			2 x 10 <sup>-4</sup>			
	BC847C/BC848C			3 x 10 <sup>-4</sup>			
DC Current Gain (Note 9)	BC846A/BC847A/BC848A	h <sub>FE</sub>	110	180	220	—	I <sub>C</sub> = 2.0mA, V <sub>CE</sub> = 5V
	BC846B/BC847B/BC848B		200	290	450		
	BC847C/BC848C		420	520	800		
Collector-Emitter Saturation Voltage (Note 9)		V <sub>CE(sat)</sub>	—	90	250	mV	I <sub>C</sub> = 10mA, I <sub>B</sub> = 0.5mA
				200	600		I <sub>C</sub> = 100mA, I <sub>B</sub> = 5.0mA
Base-Emitter Turn-On Voltage (Note 9)		V <sub>BE(on)</sub>	580	660	700	mV	I <sub>C</sub> = 2mA, V <sub>CE</sub> = 5V
			—	—	770		I <sub>C</sub> = 10mA, V <sub>CE</sub> = 5V
Base-Emitter Saturation Voltage (Note 9)		V <sub>BE(sat)</sub>	—	700	—	mV	I <sub>C</sub> = 10mA, I <sub>B</sub> = 0.5mA
				900			I <sub>C</sub> = 100mA, I <sub>B</sub> = 5mA
Output Capacitance		C <sub>obo</sub>	—	3	—	pF	V <sub>CB</sub> = 10V, f = 1.0MHz
Transition Frequency		f <sub>T</sub>	100	300	—	MHz	V <sub>CE</sub> = 5V, I <sub>C</sub> = 10mA f = 100MHz
Noise Figure		NF	—	2	10	dB	V <sub>CE</sub> = 5V, I <sub>C</sub> = 200μA R <sub>S</sub> = 2kΩ, f = 1kHz Δf = 200Hz

Note: 9. Measured under pulsed conditions. Pulse width ≤ 300μs. Duty cycle ≤ 2%.



**Typical Electrical Characteristics** (@ $T_A = +25^\circ\text{C}$ , unless otherwise specified.)

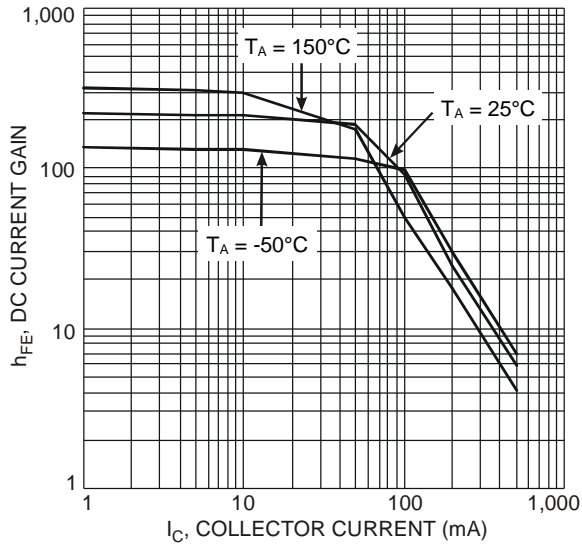

Figure 5. Typical DC Current Gain vs. Collector Current

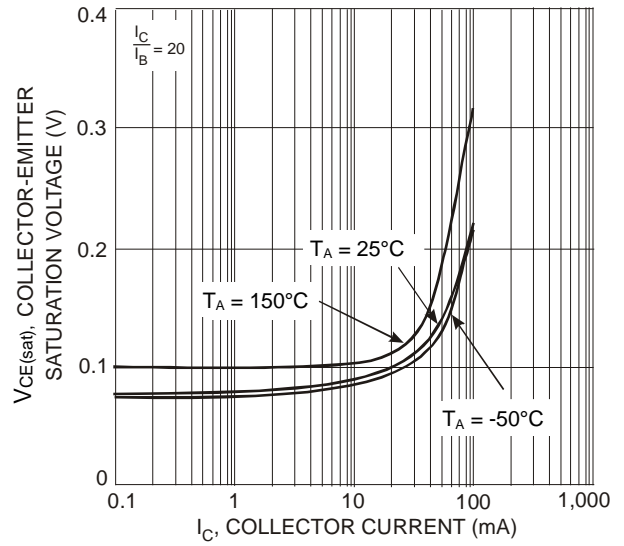

Figure 6. Typical Collector-Emitter Saturation Voltage vs. Collector Current

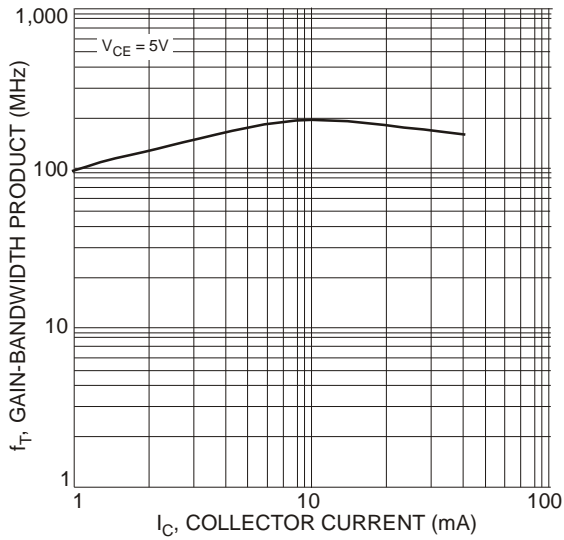
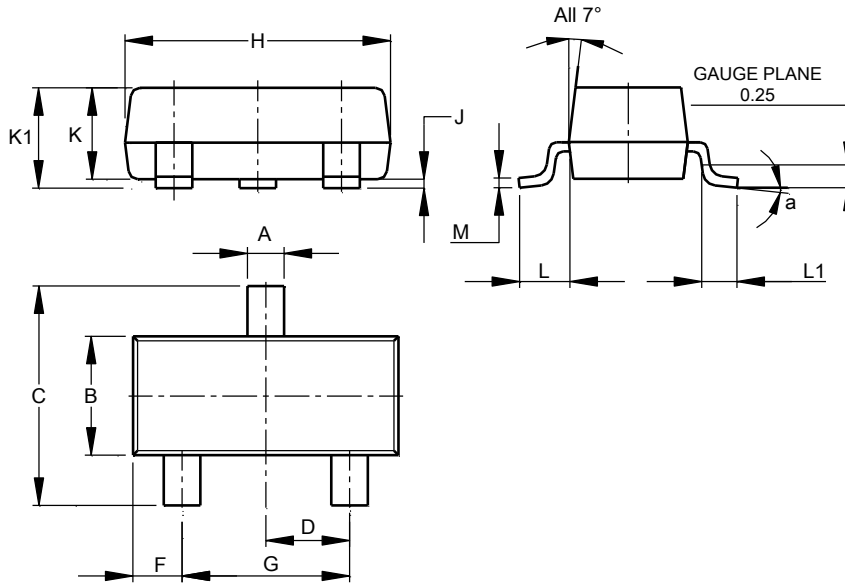

Figure 7. Typical Gain-Bandwidth Product vs. Collector Current

## Package Outline Dimensions

Please see <http://www.diodes.com/package-outlines.html> for the latest version.

### SOT23



SOT23			
Dim	Min	Max	Typ
A	0.37	0.51	0.40
B	1.20	1.40	1.30
C	2.30	2.50	2.40
D	0.89	1.03	0.915
F	0.45	0.60	0.535
G	1.78	2.05	1.83
H	2.80	3.00	2.90
J	0.013	0.10	0.05
K	0.890	1.00	0.975
K1	0.903	1.10	1.025
L	0.45	0.61	0.55
L1	0.25	0.55	0.40
M	0.085	0.150	0.110
a	0°	8°	--
All Dimensions in mm			

## Suggested Pad Layout

Please see <http://www.diodes.com/package-outlines.html> for the latest version.

### SOT23

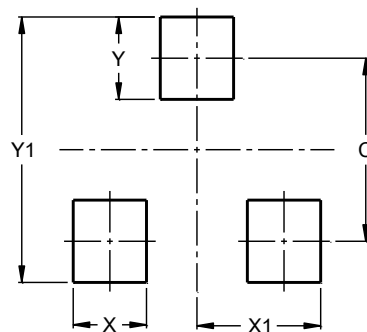

Dimensions	Value (in mm)
C	2.0
X	0.8
X1	1.35
Y	0.9
Y1	2.9





BC846A-BC848C

**IMPORTANT NOTICE**

1. DIODES INCORPORATED (Diodes) AND ITS SUBSIDIARIES MAKE NO WARRANTY OF ANY KIND, EXPRESS OR IMPLIED, WITH REGARDS TO ANY INFORMATION CONTAINED IN THIS DOCUMENT, INCLUDING, BUT NOT LIMITED TO, THE IMPLIED WARRANTIES OF MERCHANTABILITY, FITNESS FOR A PARTICULAR PURPOSE OR NON-INFRINGEMENT OF THIRD PARTY INTELLECTUAL PROPERTY RIGHTS (AND THEIR EQUIVALENTS UNDER THE LAWS OF ANY JURISDICTION).
2. The Information contained herein is for informational purpose only and is provided only to illustrate the operation of Diodes' products described herein and application examples. Diodes does not assume any liability arising out of the application or use of this document or any product described herein. This document is intended for skilled and technically trained engineering customers and users who design with Diodes' products. Diodes' products may be used to facilitate safety-related applications; however, in all instances customers and users are responsible for (a) selecting the appropriate Diodes products for their applications, (b) evaluating the suitability of Diodes' products for their intended applications, (c) ensuring their applications, which incorporate Diodes' products, comply the applicable legal and regulatory requirements as well as safety and functional-safety related standards, and (d) ensuring they design with appropriate safeguards (including testing, validation, quality control techniques, redundancy, malfunction prevention, and appropriate treatment for aging degradation) to minimize the risks associated with their applications.
3. Diodes assumes no liability for any application-related information, support, assistance or feedback that may be provided by Diodes from time to time. Any customer or user of this document or products described herein will assume all risks and liabilities associated with such use, and will hold Diodes and all companies whose products are represented herein or on Diodes' websites, harmless against all damages and liabilities.
4. Products described herein may be covered by one or more United States, international or foreign patents and pending patent applications. Product names and markings noted herein may also be covered by one or more United States, international or foreign trademarks and trademark applications. Diodes does not convey any license under any of its intellectual property rights or the rights of any third parties (including third parties whose products and services may be described in this document or on Diodes' website) under this document.
5. Diodes' products are provided subject to Diodes' Standard Terms and Conditions of Sale (<https://www.diodes.com/about/company/terms-and-conditions/terms-and-conditions-of-sales/>) or other applicable terms. This document does not alter or expand the applicable warranties provided by Diodes. Diodes does not warrant or accept any liability whatsoever in respect of any products purchased through unauthorized sales channel.
6. Diodes' products and technology may not be used for or incorporated into any products or systems whose manufacture, use or sale is prohibited under any applicable laws and regulations. Should customers or users use Diodes' products in contravention of any applicable laws or regulations, or for any unintended or unauthorized application, customers and users will (a) be solely responsible for any damages, losses or penalties arising in connection therewith or as a result thereof, and (b) indemnify and hold Diodes and its representatives and agents harmless against any and all claims, damages, expenses, and attorney fees arising out of, directly or indirectly, any claim relating to any noncompliance with the applicable laws and regulations, as well as any unintended or unauthorized application.
7. While efforts have been made to ensure the information contained in this document is accurate, complete and current, it may contain technical inaccuracies, omissions and typographical errors. Diodes does not warrant that information contained in this document is error-free and Diodes is under no obligation to update or otherwise correct this information. Notwithstanding the foregoing, Diodes reserves the right to make modifications, enhancements, improvements, corrections or other changes without further notice to this document and any product described herein. This document is written in English but may be translated into multiple languages for reference. Only the English version of this document is the final and determinative format released by Diodes.
8. Any unauthorized copying, modification, distribution, transmission, display or other use of this document (or any portion hereof) is prohibited. Diodes assumes no responsibility for any losses incurred by the customers or users or any third parties arising from any such unauthorized use.
9. This Notice may be periodically updated with the most recent version available at <https://www.diodes.com/about/company/terms-and-conditions/important-notice>

The Diodes logo is a registered trademark of Diodes Incorporated in the United States and other countries.  
All other trademarks are the property of their respective owners.  
© 2024 Diodes Incorporated. All Rights Reserved.

[www.diodes.com](http://www.diodes.com)

## OUR CERTIFICATE

DiGi provide top-quality products and perfect service for customer worldwide through standardization, technological innovation and continuous improvement. DiGi through third-party certification, we stricly control the quality of products and services. Welcome your RFQ to

Email: [Info@DiGi-Electronics.com](mailto:Info@DiGi-Electronics.com)



Tel: +00 852-30501935

RFQ Email: [Info@DiGi-Electronics.com](mailto:Info@DiGi-Electronics.com)

DiGi is a global authorized distributor of electronic components.