

# BZT52C22SQ-7-F Datasheet



<https://www.DiGi-Electronics.com>

DiGi Electronics Part Number	BZT52C22SQ-7-F-DG
Manufacturer	<a href="#">Diodes Incorporated</a>
Manufacturer Product Number	BZT52C22SQ-7-F
Description	DIODE ZENER 22V 200MW SOD323
Detailed Description	Zener Diode 22 V 200 mW $\pm$ 5.68% Surface Mount SOD-323

This model BZT52C22SQ-7-F is available at DiGi Electronics.

DiGi Electronics offers a global database of semiconductor and electronic component datasheets.

We welcome your inquiries regarding pricing, lead time, or other product-related questions.

 [Request a Quote](#)

 [Datasheet Search](#)



Tel: +00 852-30501935

RFQ Email: [Info@DiGi-Electronics.com](mailto:Info@DiGi-Electronics.com)

DiGi is a global authorized distributor of electronic components.

## Purchase and inquiry

Manufacturer Product Number:

BZT52C22SQ-7-F

Series:

-

Voltage - Zener (Nom) (Vz):

22 V

Power - Max:

200 mW

Current - Reverse Leakage @ Vr:

100 nA @ 15.4 V

Operating Temperature:

-65°C ~ 150°C (TJ)

Qualification:

AEC-Q101

Package / Case:

SC-76, SOD-323

Base Product Number:

BZT52

Manufacturer:

Diodes Incorporated

Product Status:

Obsolete

Tolerance:

±5.68%

Impedance (Max) (Zzt):

55 Ohms

Voltage - Forward (Vf) (Max) @ If:

900 mV @ 10 mA

Grade:

Automotive

Mounting Type:

Surface Mount

Supplier Device Package:

SOD-323

## Environmental & Export classification

RoHS Status:

ROHS3 Compliant

REACH Status:

REACH Unaffected

HTSUS:

8541.10.0050

Moisture Sensitivity Level (MSL):

1 (Unlimited)

ECCN:

EAR99

**BZT52C2V0S - BZT52C39S**
**SURFACE MOUNT ZENER DIODE**

## Features

- Planar Die Construction
- Small Surface Mount Package
- Ideally Suited for Automated Assembly Processes
- **Totally Lead-Free & Fully RoHS Compliant (Notes 1 & 2)**
- **Halogen and Antimony Free. "Green" Device (Notes 3 & 4)**
- **Qualified to AEC-Q101 Standards for High Reliability**

## Mechanical Data

- Case: SOD323
- Case Material: Molded Plastic.  
UL Flammability Classification Rating 94V-0
- Moisture Sensitivity: Level 1 per J-STD-020
- Terminals: Matte Tin Finish Annealed over Alloy 42 Leadframe (Lead Free Plating).  
Solderable per MIL-STD-202, Method 208
- Polarity: Cathode Band
- Weight: 0.0049 grams (Approximate)

SOD323



Top View

## Ordering Information (Note 5)

Part Number	Qualification	Case	Packaging
(Type Number)-7-F*	Commercial	SOD323	3,000/Tape & Reel
(Type Number)Q-7-F*	Automotive	SOD323	3,000/Tape & Reel

\*Add "-7-F" to the appropriate type number in Electrical Characteristics Table, example: 6.2V Zener – BZT52C6V2S-7-F.

- Notes:
1. No purposely added lead. Fully EU Directive 2002/95/EC (RoHS) & 2011/65/EU (RoHS 2) compliant.
  2. See [http://www.diodes.com/quality/lead\\_free.html](http://www.diodes.com/quality/lead_free.html) for more information about Diodes Incorporated's definitions of Halogen- and Antimony-free, "Green" and Lead-free.
  3. Halogen- and Antimony-free "Green" products are defined as those which contain <900ppm bromine, <900ppm chlorine (<1500ppm total Br + Cl) and <1000ppm antimony compounds.
  4. Product manufactured with Date Code V9 (week 33, 2008) and newer are built with Green Molding Compound. Products manufactured prior to Date Code V9 are built with Non-Green Molding Compound and may contain Halogens or Sb<sub>2</sub>O<sub>3</sub> Fire Retardants.
  5. For packaging details, go to our website at <http://www.diodes.com/products/packages.html>.

## Marking Information

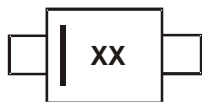

XX = Product Type Marking Code for SAT (Shanghai Assembly / Test site)  
(See Electrical Characteristics Table)

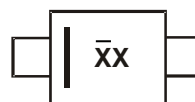

XX = Product Type Marking Code for CAT (Chengdu Assembly / Test site)  
(See Electrical Characteristics Table)



## BZT52C2V0S - BZT52C39S

### Maximum Ratings (@T<sub>A</sub> = +25°C, unless otherwise specified.)

Single phase, half wave, 60Hz, resistive or inductive load.  
For capacitance load, derate current by 20%.

Characteristic	Symbol	Value	Unit
Forward Voltage (Note 6) @I <sub>F</sub> = 10mA	V <sub>F</sub>	0.9	V

### Thermal Characteristics

Characteristic	Symbol	Value	Unit
Power Dissipation (Note 7)	P <sub>D</sub>	200	mW
Thermal Resistance, Junction to Ambient Air (Note 7)	R <sub>θJA</sub>	625	°C/W
Operating and Storage Temperature Range	T <sub>J</sub> , T <sub>STG</sub>	-65 to +150	°C

### Electrical Characteristics (@T<sub>A</sub> = +25°C, unless otherwise specified.)

Type Number	Marking Code	Zener Voltage Range (Note 4)				Maximum Zener Impedance f = 1kHz			Maximum Reverse Current (Note 6)		Temperature Coefficient of Zener Voltage @I <sub>ZT</sub> = 5mA mV/°C	
		V <sub>Z</sub> @I <sub>ZT</sub>			I <sub>ZT</sub>	Z <sub>ZT</sub> @I <sub>ZT</sub>	Z <sub>ZK</sub> @I <sub>ZK</sub>	I <sub>ZK</sub>	I <sub>R</sub>	@V <sub>R</sub>	Min	Max
		Nom (V)	Min (V)	Max (V)	(mA)	Ω	mA	μA	V			
BZT52C2V0S	WY	2.0	1.91	2.09	5	100	600	1.0	150	1.0	-3.5	0
BZT52C2V4S	WX	2.4	2.20	2.60	5	100	600	1.0	50	1.0	-3.5	0
BZT52C2V7S	W1	2.7	2.5	2.9	5	100	600	1.0	20	1.0	-3.5	0
BZT52C3V0S	W2	3.0	2.8	3.2	5	95	600	1.0	10	1.0	-3.5	0
BZT52C3V3S	W3	3.3	3.1	3.5	5	95	600	1.0	5	1.0	-3.5	0
BZT52C3V6S	W4	3.6	3.4	3.8	5	90	600	1.0	5	1.0	-3.5	0
BZT52C3V9S	W5	3.9	3.7	4.1	5	90	600	1.0	3	1.0	-3.5	0
BZT52C4V3S	W6	4.3	4.0	4.6	5	90	600	1.0	3	1.0	-3.5	0
BZT52C4V7S	W7	4.7	4.4	5.0	5	80	500	1.0	2	2.0	-3.5	0.2
BZT52C5V1S	W8	5.1	4.8	5.4	5	60	480	1.0	1	2.0	-2.7	1.2
BZT52C5V6S	W9	5.6	5.2	6.0	5	40	400	1.0	3	2.0	-2.0	2.5
BZT52C6V2S	WA	6.2	5.8	6.6	5	10	150	1.0	2	4.0	0.4	3.7
BZT52C6V8S	WB	6.8	6.4	7.2	5	15	80	1.0	1	4.0	1.2	4.5
BZT52C7V5S	WC	7.5	7.0	7.9	5	15	80	1.0	0.7	5.0	2.5	5.3
BZT52C8V2S	WD	8.2	7.7	8.7	5	15	80	1.0	0.5	5.0	3.2	6.2
BZT52C9V1S	WE	9.1	8.5	9.6	5	15	100	1.0	0.2	6.0	3.8	7.0
BZT52C10S	WF	10	9.4	10.6	5	20	150	1.0	0.1	7.0	4.5	8.0
BZT52C11S	WG	11	10.4	11.6	5	20	150	1.0	0.1	8.0	5.4	9.0
BZT52C12S	WH	12	11.4	12.7	5	25	150	1.0	0.1	8.0	6.0	10.0
BZT52C13S	WI	13	12.4	14.1	5	30	170	1.0	0.1	8.0	7.0	11.0
BZT52C15S	WJ	15	13.8	15.6	5	30	200	1.0	0.1	10.5	9.2	13.0
BZT52C16S	WK	16	15.3	17.1	5	40	200	1.0	0.1	11.2	10.4	—
BZT52C18S	WL	18	16.8	19.1	5	45	225	1.0	0.1	12.6	12.4	—
BZT52C20S	WM	20	18.8	21.2	5	55	225	1.0	0.1	14.0	14.4	—
BZT52C22S	WN	22	20.8	23.3	5	55	250	1.0	0.1	15.4	16.4	—
BZT52C24S	WO	24	22.8	25.6	5	70	250	1.0	0.1	16.8	18.4	—
BZT52C27S	WP	27	25.1	28.9	2	80	300	0.5	0.1	18.9	21.4	—
BZT52C30S	WQ	30	28.0	32.0	2	80	300	0.5	0.1	21.0	24.4	—
BZT52C33S	WR	33	31.0	35.0	2	80	325	0.5	0.1	23.1	27.4	—
BZT52C36S	WS	36	34.0	38.0	2	90	350	0.5	0.1	25.2	30.4	—
BZT52C39S	WT	39	37.0	41.0	2	130	350	0.5	0.1	27.3	33.4	—

Notes: 6. Short duration pulse test used to minimize self-heating effect.  
7. Part mounted on FR-4 PC board with recommended pad layout, as per <http://www.diodes.com/package-outlines.html>.



**BZT52C2V0S - BZT52C39S**

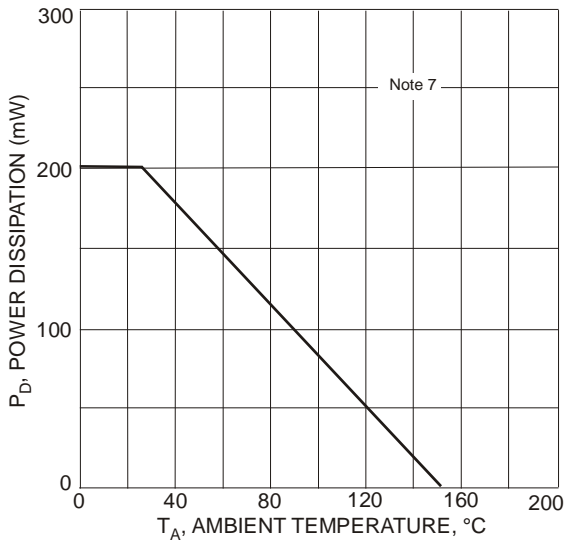

Fig. 1 Power Derating Curve

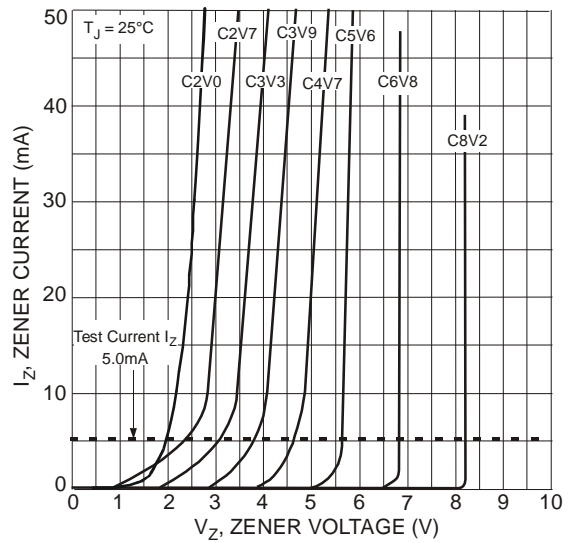

Fig. 2 Typical Zener Breakdown Characteristics

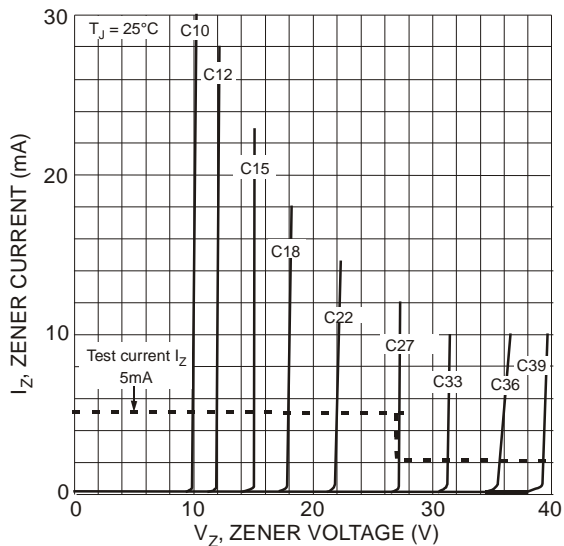

Fig. 3 Typical Zener Breakdown Characteristics

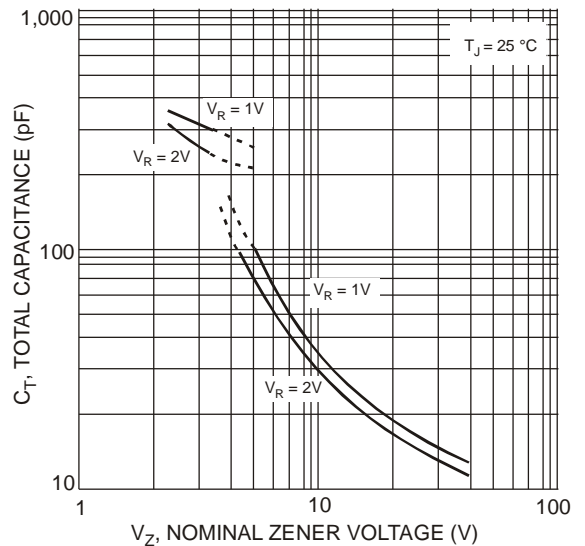
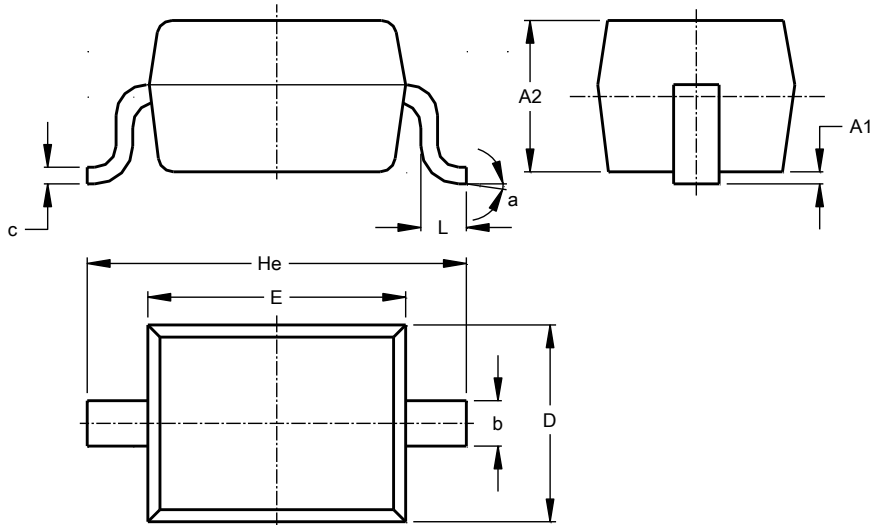

Fig. 4 Typical Total Capacitance vs. Nominal Zener Voltage

## Package Outline Dimensions

Please see <http://www.diodes.com/package-outlines.html> for the latest version.

SOD323



SOD323			
Dim	Min	Max	Typ
A1	--	0.10	0.05
A2	1.00	1.10	1.05
b	0.25	0.35	0.30
c	0.10	0.15	0.11
D	1.20	1.40	1.30
E	1.60	1.80	1.70
He	2.30	2.70	2.50
L	0.20	0.40	0.30
a	0°	8°	--
All Dimensions in mm			

## Suggested Pad Layout

Please see <http://www.diodes.com/package-outlines.html> for the latest version.

SOD323

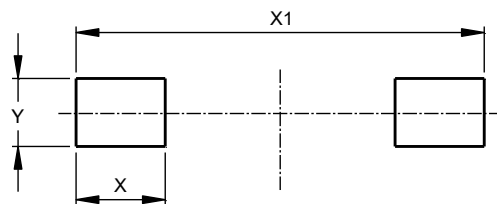

Dimensions	Value (in mm)
X	0.590
X1	2.700
Y	0.450



#### IMPORTANT NOTICE

DIODES INCORPORATED MAKES NO WARRANTY OF ANY KIND, EXPRESS OR IMPLIED, WITH REGARDS TO THIS DOCUMENT, INCLUDING, BUT NOT LIMITED TO, THE IMPLIED WARRANTIES OF MERCHANTABILITY AND FITNESS FOR A PARTICULAR PURPOSE (AND THEIR EQUIVALENTS UNDER THE LAWS OF ANY JURISDICTION).

Diodes Incorporated and its subsidiaries reserve the right to make modifications, enhancements, improvements, corrections or other changes without further notice to this document and any product described herein. Diodes Incorporated does not assume any liability arising out of the application or use of this document or any product described herein; neither does Diodes Incorporated convey any license under its patent or trademark rights, nor the rights of others. Any Customer or user of this document or products described herein in such applications shall assume all risks of such use and will agree to hold Diodes Incorporated and all the companies whose products are represented on Diodes Incorporated website, harmless against all damages.

Diodes Incorporated does not warrant or accept any liability whatsoever in respect of any products purchased through unauthorized sales channel. Should Customers purchase or use Diodes Incorporated products for any unintended or unauthorized application, Customers shall indemnify and hold Diodes Incorporated and its representatives harmless against all claims, damages, expenses, and attorney fees arising out of, directly or indirectly, any claim of personal injury or death associated with such unintended or unauthorized application.

Products described herein may be covered by one or more United States, international or foreign patents pending. Product names and markings noted herein may also be covered by one or more United States, international or foreign trademarks.

This document is written in English but may be translated into multiple languages for reference. Only the English version of this document is the final and determinative format released by Diodes Incorporated.

#### LIFE SUPPORT

Diodes Incorporated products are specifically not authorized for use as critical components in life support devices or systems without the express written approval of the Chief Executive Officer of Diodes Incorporated. As used herein:

A. Life support devices or systems are devices or systems which:

1. are intended to implant into the body, or
2. support or sustain life and whose failure to perform when properly used in accordance with instructions for use provided in the labeling can be reasonably expected to result in significant injury to the user.

B. A critical component is any component in a life support device or system whose failure to perform can be reasonably expected to cause the failure of the life support device or to affect its safety or effectiveness.

Customers represent that they have all necessary expertise in the safety and regulatory ramifications of their life support devices or systems, and acknowledge and agree that they are solely responsible for all legal, regulatory and safety-related requirements concerning their products and any use of Diodes Incorporated products in such safety-critical, life support devices or systems, notwithstanding any devices- or systems-related information or support that may be provided by Diodes Incorporated. Further, Customers must fully indemnify Diodes Incorporated and its representatives against any damages arising out of the use of Diodes Incorporated products in such safety-critical, life support devices or systems.

Copyright © 2017, Diodes Incorporated

[www.diodes.com](http://www.diodes.com)

## OUR CERTIFICATE

DiGi provide top-quality products and perfect service for customer worldwide through standardization, technological innovation and continuous improvement. DiGi through third-party certification, we strictly control the quality of products and services. Welcome your RFQ to

Email: [Info@DiGi-Electronics.com](mailto:Info@DiGi-Electronics.com)



Tel: +00 852-30501935

RFQ Email: [Info@DiGi-Electronics.com](mailto:Info@DiGi-Electronics.com)

DiGi is a global authorized distributor of electronic components.