

DCX124EU-7-F Datasheet

www.digi-electronics.com

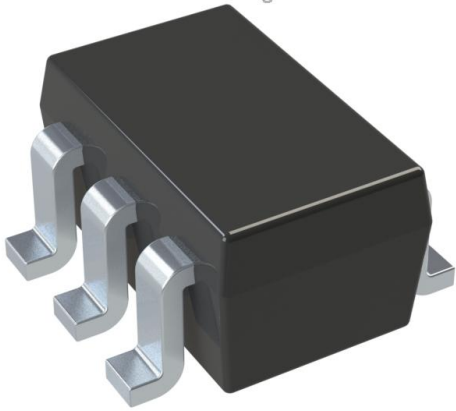

<https://www.DiGi-Electronics.com>

DiGi Electronics Part Number	DCX124EU-7-F-DG
Manufacturer	Diodes Incorporated
Manufacturer Product Number	DCX124EU-7-F
Description	TRANS NPN/PNP PREBIAS SOT363
Detailed Description	Pre-Biased Bipolar Transistor (BJT) 1 NPN, 1 PNP - Pre-Biased (Dual) 50V 100mA 250MHz 200mW Surface Mount SOT-363



Tel: +00 852-30501935

RFQ Email: Info@DiGi-Electronics.com

DiGi is a global authorized distributor of electronic components.

Purchase and inquiry

Manufacturer Product Number:

DCX124EU-7-F

Series:

-

Transistor Type:

1 NPN, 1 PNP - Pre-Biased (Dual)

Voltage - Collector Emitter Breakdown (Max):

50V

Resistor - Emitter Base (R2):

22kOhms

Vce Saturation (Max) @ Ib, Ic:

300mV @ 500μA, 10mA

Frequency - Transition:

250MHz

Mounting Type:

Surface Mount

Supplier Device Package:

SOT-363

Manufacturer:

Diodes Incorporated

Product Status:

Active

Current - Collector (Ic) (Max):

100mA

Resistor - Base (R1):

22kOhms

DC Current Gain (hFE) (Min) @ Ic, Vce:

56 @ 5mA, 5V

Current - Collector Cutoff (Max):

500nA

Power - Max:

200mW

Package / Case:

6-TSSOP, SC-88, SOT-363

Base Product Number:

DCX124

Environmental & Export classification

RoHS Status:

ROHS3 Compliant

REACH Status:

REACH Unaffected

HTSUS:

8541.21.0075

Moisture Sensitivity Level (MSL):

1 (Unlimited)

ECCN:

EAR99

Features

- Supply Voltage $V_O = 50V$
- Range of Bias Resistors
- Surface-Mount Package Suited for Automated Assembly
- Totally Lead-Free & Fully RoHS Compliant (Notes 1 & 2)**
- Halogen and Antimony Free. "Green" Device (Note 3)**
- The DCX (XXXX) UQs are suitable for automotive applications requiring specific change control; these parts are AEC-Q101 qualified, PPAP capable, and manufactured in IATF 16949 certified facilities.**

<https://www.diodes.com/quality/product-definitions/>

Part Number	R1(NOM)	R2(NOM)
DCX124EU	22k Ω	22k Ω
DCX144EU	47k Ω	47k Ω
DCX114YU	10k Ω	47k Ω
DCX123JU	2.2k Ω	47k Ω
DCX114EU	10k Ω	10k Ω
DCX143EU	4.7k Ω	4.7k Ω
DCX143ZU	4.7k Ω	47k Ω
DCX115EU	100k Ω	100k Ω

Mechanical Data

- Package: SOT363
- Package Material: Molded Plastic, "Green" Molding Compound; UL Flammability Classification Rating 94V-0
- Moisture Sensitivity: Level 1 per J-STD-020
- Terminals: Finish – Matte Tin Plated Leads, Solderable per MIL-STD-202, Method 208 Ⓒ3
- Weight: 0.006 grams (Approximate)

Part Number	R1 Only
DCX143TU	4.7k Ω
DCX114TU	10k Ω

SOT363

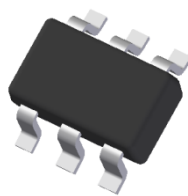

Top View

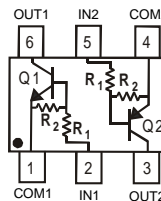

R1, R2

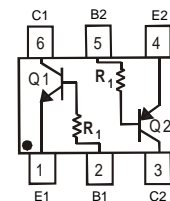

R1 Only

Device Schematic

Ordering Information (Notes 4, 5)

Part Number	Status	Package	Marking	Reel Size (inches)	Tape Width (mm)	Packing	
						Qty.	Carrier
DCX124EU-7-F	Active	SOT363	C17	7	8	3,000	Reel
DCX124EU-13-F	Active	SOT363	C17	13	8	10,000	Reel
DCX124EUQ-7-F	NRND (Use ACX124EUQ)	SOT363	C17	7	8	3,000	Reel
DCX124EUQ-13-F	NRND (Use ACX124EUQ)	SOT363	C17	13	8	10,000	Reel
DCX124EUQ-13R-F	NRND (Use ACX124EUQ)	SOT363	C17	13	8	10,000	Reel
DCX144EU-7-F	Active	SOT363	C20	7	8	3,000	Reel
DCX144EU-7R-F	Active	SOT363	C20	7	8	3,000	Reel
DCX144EUQ-7-F	Active	SOT363	C20	7	8	3,000	Reel
DCX144EUQ-7R-F	Active	SOT363	C20	7	8	3,000	Reel
DCX114YU-7-F	Active	SOT363	C14	7	8	3,000	Reel
DCX114YU-7R-F	Active	SOT363	C14	7	8	3,000	Reel
DCX114YUQ-7-F	NRND (Use ACX114YUQ)	SOT363	C14	7	8	3,000	Reel
DCX114YUQ-13-F	NRND (Use ACX114YUQ)	SOT363	C14	13	8	10,000	Reel
DCX114YUQ-13R-F	NRND (Use ACX114YUQ)	SOT363	C14	13	8	10,000	Reel
DCX123JU-7-F	Active	SOT363	C06	7	8	3,000	Reel
DCX123JU-7R-F	Active	SOT363	C06	7	8	3,000	Reel
DCX123JUQ-7-F	Active	SOT363	C06	7	8	3,000	Reel
DCX114EU-7-F	Active	SOT363	C13	7	8	3,000	Reel
DCX114EU-13R-F	Active	SOT363	C13	13	8	10,000	Reel

Ordering Information (Notes 4, 5) (continued)

Part Number	Status	Package	Marking	Reel Size (inches)	Tape Width (mm)	Packing	
						Qty.	Carrier
DCX114EUQ-7-F	NRND (Use ACX114EUQ)	SOT363	C13	7	8	3,000	Reel
DCX114EUQ-13-F	NRND (Use ACX114EUQ)	SOT363	C13	13	8	10,000	Reel
DCX114EUQ-13R-F	NRND (Use ACX114EUQ)	SOT363	C13	13	8	10,000	Reel
DCX143TU-7-F	Active	SOT363	C07	7	8	3,000	Reel
DCX143EU-7-F	Active	SOT363	C08	7	8	3,000	Reel
DCX143EU-7R-F	Active	SOT363	C08	7	8	3,000	Reel
DCX114TU-7-F	Active	SOT363	C12	7	8	3,000	Reel
DCX143ZU-7-F	Active	SOT363	C02	7	8	3,000	Reel
DCX143ZU-7R-F	Active	SOT363	C02	7	8	3,000	Reel
DCX115EU-7-F	Active	SOT363	C01	7	8	3,000	Reel

- Notes:
1. No purposely added lead. Fully EU Directive 2002/95/EC (RoHS), 2011/65/EU (RoHS 2) & 2015/863/EU (RoHS 3) compliant.
 2. See <https://www.diodes.com/quality/lead-free/> for more information about Diodes Incorporated's definitions of Halogen- and Antimony-free, "Green" and Lead-free.
 3. Halogen- and Antimony-free "Green" products are defined as those which contain <900ppm bromine, <900ppm chlorine (<1500ppm total Br + Cl) and <1000ppm antimony compounds.
 4. For packaging details, go to our website at <https://www.diodes.com/design/support/packaging/diodes-packaging/>.
 5. NRND = Not Recommended for New Design.

Marking Information

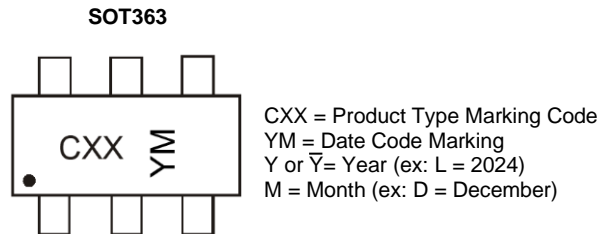

Date Code Key

Year	2010	-	2024	2025	2026	2027	2028	2029	2030	2031	2032	2033
Code	X	-	L	M	N	P	R	S	T	U	V	W

Month	Jan	Feb	Mar	Apr	May	Jun	Jul	Aug	Sep	Oct	Nov	Dec
Code	1	2	3	4	5	6	7	8	9	O	N	D



DCX (XXXX) U

Absolute Maximum Ratings NPN Section (@ $T_A = +25^\circ\text{C}$, unless otherwise specified.)

Characteristic		Symbol	Value	Unit
Supply Voltage		V_o	50	V
Input Voltage	DCX124EU	V_i	-10 to +40	V
	DCX144EU		-10 to +40	
	DCX114YU		-6 to +40	
	DCX123JU		-5 to +12	
	DCX114EU		-10 to +40	
	DCX143TU		-5V Max	
	DCX143EU		-10 to +30	
	DCX114TU		-5V Max	
	DCX143ZU		-10 to +30	
DCX115EU	-10 to +40			
Output Current	DCX124EU	I_o	30	mA
	DCX144EU		30	
	DCX114YU		70	
	DCX123JU		100	
	DCX114EU		50	
	DCX143TU		100	
	DCX143EU		100	
	DCX114TU		100	
	DCX143ZU		100	
DCX115EU	20			
Peak Output Current		I_{CM}	100	mA

Absolute Maximum Ratings PNP Section (@ $T_A = +25^\circ\text{C}$, unless otherwise specified.)

Characteristic		Symbol	Value	Unit
Supply Voltage		V_o	50	V
Input Voltage	DCX124EU	V_i	+10 to -40	V
	DCX144EU		+10 to -40	
	DCX114YU		+6 to -40	
	DCX123JU		+5 to -12	
	DCX114EU		+10 to -40	
	DCX143TU		+5V Max	
	DCX143EU		+10 to -30	
	DCX114TU		+5V Max	
	DCX143ZU		+5 to -30	
DCX115EU	+10 to -40			
Output Current	DCX124EU	I_o	-30	mA
	DCX144EU		-30	
	DCX114YU		-70	
	DCX123JU		-100	
	DCX114EU		-50	
	DCX143TU		-100	
	DCX143EU		-100	
	DCX114TU		-100	
	DCX143ZU		-100	
DCX115EU	-20			
Peak Output Current		I_{CM}	-100	mA

Thermal Characteristics (@ $T_A = +25^\circ\text{C}$, unless otherwise specified.)

Characteristic	Symbol	Value	Unit
Power Dissipation (Notes 6, 7)	P_D	200	mW
Thermal Resistance, Junction to Ambient Air (Note 6)	$R_{\theta JA}$	625	$^\circ\text{C}/\text{W}$
Operating and Storage Temperature Range	T_J, T_{STG}	-55 to +150	$^\circ\text{C}$

Notes: 6. Mounted on FR-4 PC Board with minimum recommended pad layout.
7. 150mW per element must not be exceeded.

Thermal Characteristics (@ $T_A = +25^\circ\text{C}$, unless otherwise specified.)

Fig. 1 Power Derating Curve



DCX (XXXX) U

Electrical Characteristics NPN Section (@ $T_A = +25^\circ\text{C}$, unless otherwise specified.)

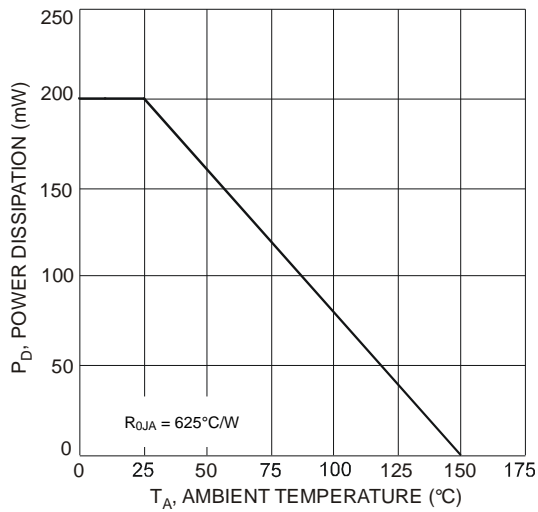
Characteristic	Symbol	Min	Typ	Max	Unit	Test Condition	
R1 Only (DCX143TU & DCX114TU)							
Collector-Base Breakdown Voltage	BV_{CBO}	50	—	—	V	$I_C = 50\mu\text{A}$	
Collector-Emitter Breakdown Voltage	BV_{CEO}	50	—	—	V	$I_C = 1\text{mA}$	
Emitter-Base Breakdown Voltage	BV_{EBO}	5	—	—	V	$I_E = 50\mu\text{A}$	
Collector Cutoff Current	I_{CBO}	—	—	0.5	μA	$V_{CB} = 50\text{V}$	
Emitter Cutoff Current	I_{EBO}	—	—	0.5	μA	$V_{EB} = 4\text{V}$	
Collector-Emitter Saturation Voltage	$V_{CE(sat)}$	—	—	0.3	V	$I_C/I_B = 2.5\text{mA} / 0.25\text{mA}$ DCX143TU $I_C/I_B = 1\text{mA} / 0.1\text{mA}$ DCX114TU	
DC Current Transfer Ratio	h_{FE}	100	250	600	—	$I_C = 1\text{mA}$, $V_{CE} = 5\text{V}$	
Input Resistor (R_1) Tolerance	ΔR_1	-30	—	+30	%	—	
Gain-Bandwidth Product	f_T	—	250	—	MHz	$V_{CE} = 10\text{V}$, $I_E = 5\text{mA}$, $f = 100\text{MHz}$	
R1/R2 Only							
Input Voltage	DCX124EU	$V_{I(off)}$	0.5	1.1	—	V	$V_{CC} = 5\text{V}$, $I_O = 100\mu\text{A}$
	DCX144EU		0.5	1.1			
	DCX114YU		0.3	—			
	DCX123JU		0.5	—			
	DCX114EU		0.5	1.1			
	DCX143EU		0.5	1.16			
	DCX143ZU		0.5	—			
	DCX115EU		0.5	—			
	DCX124EU	$V_{I(on)}$	—	1.9	3.0	V	$V_O = 0.3\text{V}$, $I_O = 5\text{mA}$
	DCX144EU		—	1.9	3.0		$V_O = 0.3\text{V}$, $I_O = 2\text{mA}$
	DCX114YU		—	—	1.4		$V_O = 0.3\text{V}$, $I_O = 1\text{mA}$
	DCX123JU		—	—	1.1		$V_O = 0.3\text{V}$, $I_O = 5\text{mA}$
	DCX114EU		—	1.9	3.0		$V_O = 0.3\text{V}$, $I_O = 10\text{mA}$
	DCX143EU		—	1.99	3.0		$V_O = 0.3\text{V}$, $I_O = 20\text{mA}$
DCX143ZU	—		—	1.3	$V_O = 0.3\text{V}$, $I_O = 5\text{mA}$		
DCX115EU	—	—	3	$V_O = 0.3\text{V}$, $I_O = 1\text{mA}$			
Output Voltage	DCX124EU	$V_{O(on)}$	—	0.1	0.3	V	$I_O/I_I = 10\text{mA} / 0.5\text{mA}$
	DCX144EU		—	0.1	0.3		$I_O/I_I = 10\text{mA} / 0.5\text{mA}$
	DCX114YU		—	0.1	0.3		$I_O/I_I = 5\text{mA} / 0.25\text{mA}$
	DCX123JU		—	0.1	0.3		$I_O/I_I = 5\text{mA} / 0.25\text{mA}$
	DCX114EU		—	0.1	0.3		$I_O/I_I = 10\text{mA} / 0.5\text{mA}$
	DCX143EU		—	0.1	0.3		$I_O/I_I = 10\text{mA} / 0.5\text{mA}$
	DCX143ZU		—	0.1	0.3		$I_O/I_I = 5\text{mA} / 0.25\text{mA}$
	DCX115EU		—	0.1	0.3		$I_O/I_I = 10\text{mA} / 0.5\text{mA}$
Input Current	DCX124EU	I_I	—	—	0.36	mA	$V_I = 5\text{V}$
	DCX144EU		—	—	0.18		
	DCX114YU		—	—	0.88		
	DCX123JU		—	—	3.6		
	DCX114EU		—	—	0.88		
	DCX143EU		—	—	0.88		
	DCX143ZU		—	—	1.8		
	DCX115EU		—	—	0.15		
Output Current	$I_{O(off)}$	—	—	0.5	μA	$V_{CC} = 50\text{V}$, $V_I = 0\text{V}$	
DC Current Gain	DCX124EU	G_I	56	—	—	—	$V_O = 5\text{V}$, $I_O = 5\text{mA}$
	DCX124EUQ		60				$V_O = 5\text{V}$, $I_O = 5\text{mA}$
	DCX144EU		68				$V_O = 5\text{V}$, $I_O = 5\text{mA}$
	DCX114YU		68				$V_O = 5\text{V}$, $I_O = 10\text{mA}$
	DCX114YUQ		80				$V_O = 5\text{V}$, $I_O = 10\text{mA}$
	DCX123JU		80				$V_O = 5\text{V}$, $I_O = 10\text{mA}$
	DCX114EU		30				$V_O = 5\text{V}$, $I_O = 5\text{mA}$
	DCX143EU		50				$V_O = 5\text{V}$, $I_O = 10\text{mA}$
	DCX143ZU		80				$V_O = 5\text{V}$, $I_O = 10\text{mA}$
DCX115EU	82	$V_O = 5\text{V}$, $I_O = 5\text{mA}$					
Input Resistor (R_1) Tolerance	ΔR_1	-30	—	+30	%	—	
Resistance Ratio Tolerance	$\Delta R_2/R_1$	-20	—	+20	%	—	
Gain-Bandwidth Product	f_T	—	250	—	MHz	$V_{CE} = 10\text{V}$, $I_E = 5\text{mA}$, $f = 100\text{MHz}$	



DCX (XXXX) U

Electrical Characteristics PNP Section (@ $T_A = +25^\circ\text{C}$, unless otherwise specified.)

Characteristic		Symbol	Min	Typ	Max	Unit	Test Condition	
R1 Only (DCX143TU & DCX114TU)								
Collector-Base Breakdown Voltage		BV_{CBO}	-50	—	—	V	$I_C = -50\mu\text{A}$	
Collector-Emitter Breakdown Voltage		BV_{CEO}	-50	—	—	V	$I_C = -1\text{mA}$	
Emitter-Base Breakdown Voltage		BV_{EBO}	-5	—	—	V	$I_E = -50\mu\text{A}$	
Collector Cutoff Current		I_{CBO}	—	—	-0.5	μA	$V_{CB} = -50\text{V}$	
Emitter Cutoff Current		I_{EBO}	—	—	-0.5	μA	$V_{EB} = -4\text{V}$	
Collector-Emitter Saturation Voltage		$V_{CE(sat)}$	—	—	-0.3	V	$I_C/I_B = 2.5\text{mA} / 0.25\text{mA}$ DCX143TU $I_C/I_B = 1\text{mA} / 0.1\text{mA}$ DCX114TU	
DC Current Transfer Ratio		h_{FE}	100	250	600	—	$I_C = -1\text{mA}$, $V_{CE} = -5\text{V}$	
Input Resistor (R_1) Tolerance		ΔR_1	-30	—	+30	%	—	
Gain-Bandwidth Product		f_T	—	250	—	MHz	$V_{CE} = -10\text{V}$, $I_E = -5\text{mA}$, $f = 100\text{MHz}$	
R1/R2 Only								
Input Voltage	DCX124EU	$V_{I(off)}$	-0.5	-1.1	—	V	$V_{CC} = -5\text{V}$, $I_O = -100\mu\text{A}$	
	DCX144EU		-0.5	-1.1				
	DCX114YU		-0.3	—				
	DCX123JU		-0.5	—				
	DCX114EU		-0.5	-1.1				
	DCX143EU		-0.5	-1.16				
	DCX143ZU		-0.5	—				
	DCX115EU		-0.5	—				
	DCX124EU	$V_{I(on)}$	—	-1.9	-3.0	V	$V_O = -0.3\text{V}$, $I_O = -5\text{mA}$	
	DCX144EU		—	-1.9	-3.0		$V_O = -0.3\text{V}$, $I_O = -2\text{mA}$	
	DCX114YU		—	—	-1.4		$V_O = -0.3\text{V}$, $I_O = -1\text{mA}$	
	DCX123JU		—	—	-1.1		$V_O = -0.3\text{V}$, $I_O = -5\text{mA}$	
	DCX114EU		—	-1.9	-3.0		$V_O = -0.3\text{V}$, $I_O = -10\text{mA}$	
	DCX143EU		—	-2.5	-3.0		$V_O = -0.3\text{V}$, $I_O = -20\text{mA}$	
DCX143ZU	—		—	-1.3	$V_O = -0.3\text{V}$, $I_O = -5\text{mA}$			
DCX115EU	—	—	-3	$V_O = -0.3\text{V}$, $I_O = -1\text{mA}$				
Output Voltage	DCX124EU	$V_{O(on)}$	—	-0.1	-0.3	V	$I_O/I_I = -10\text{mA} / -0.5\text{mA}$	
	DCX144EU						$I_O/I_I = -10\text{mA} / -0.5\text{mA}$	
	DCX114YU						$I_O/I_I = -5\text{mA} / -0.25\text{mA}$	
	DCX123JU						$I_O/I_I = -5\text{mA} / -0.25\text{mA}$	
	DCX114EU						$I_O/I_I = -10\text{mA} / -0.5\text{mA}$	
	DCX143EU						$I_O/I_I = -10\text{mA} / -0.5\text{mA}$	
	DCX143ZU						$I_O/I_I = -5\text{mA} / -0.25\text{mA}$	
	DCX115EU						$I_O/I_I = -10\text{mA} / -0.5\text{mA}$	
Input Current	DCX124EU	I_I	—	—	-0.36	mA	$V_I = -5\text{V}$	
	DCX144EU							-0.18
	DCX114YU							-0.88
	DCX123JU							-3.6
	DCX114EU							-0.88
	DCX143EU							-0.88
	DCX143ZU							-1.8
	DCX115EU							-0.15
Output Current		$I_{O(off)}$	—	—	-0.5	μA	$V_{CC} = -50\text{V}$, $V_I = 0\text{V}$	
DC Current Gain	DCX124EU	G_i	56	—	—	—	$V_O = -5\text{V}$, $I_O = -5\text{mA}$	
	DCX124EUQ						60	$V_O = -5\text{V}$, $I_O = -5\text{mA}$
	DCX144EU						68	$V_O = -5\text{V}$, $I_O = -5\text{mA}$
	DCX114YU						68	$V_O = -5\text{V}$, $I_O = -10\text{mA}$
	DCX114YUQ						80	$V_O = -5\text{V}$, $I_O = -10\text{mA}$
	DCX123JU						80	$V_O = -5\text{V}$, $I_O = -10\text{mA}$
	DCX114EU						30	$V_O = -5\text{V}$, $I_O = -5\text{mA}$
	DCX143EU						40	$V_O = -5\text{V}$, $I_O = -10\text{mA}$
	DCX143ZU						80	$V_O = -5\text{V}$, $I_O = -10\text{mA}$
DCX115EU	82	$V_O = -5\text{V}$, $I_O = -5\text{mA}$						
Input Resistor (R_1) Tolerance		ΔR_1	-30	—	+30	%	—	
Resistance Ratio Tolerance		$\Delta R_2/R_1$	-20	—	+20	%	—	
Gain-Bandwidth Product		f_T	—	250	—	MHz	$V_{CE} = -10\text{V}$, $I_E = -5\text{mA}$, $f = 100\text{MHz}$	



DCX (XXXX) U

Typical Curves – DCX123JU PNP Section (@ $T_A = +25^\circ\text{C}$, unless otherwise specified.)

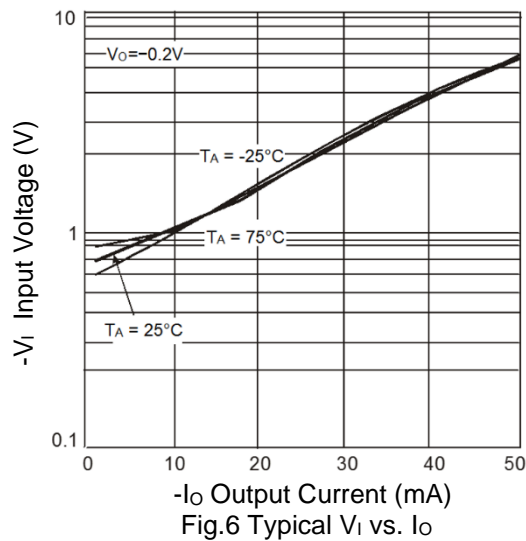
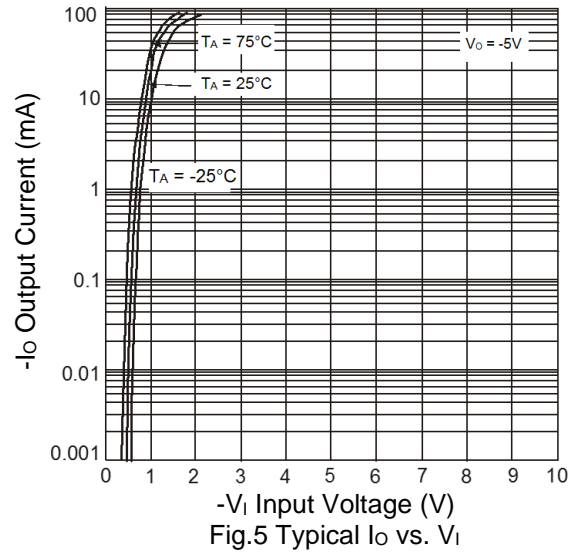
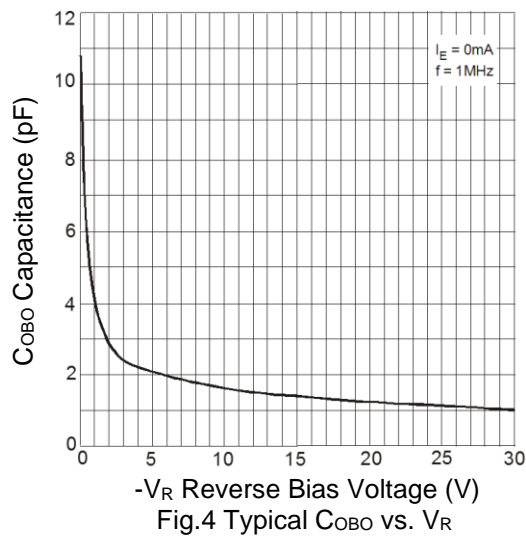
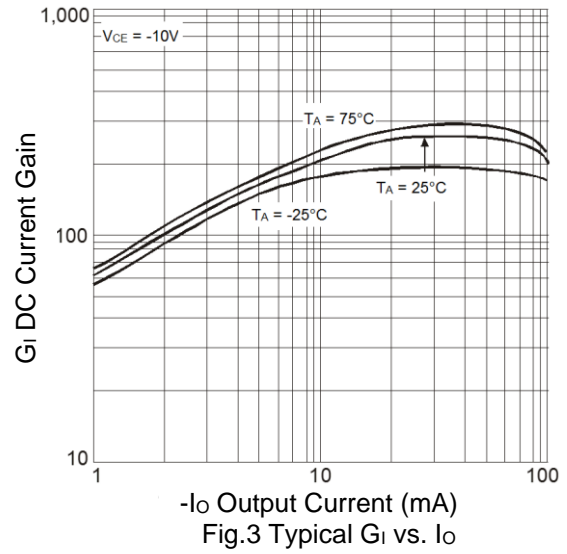
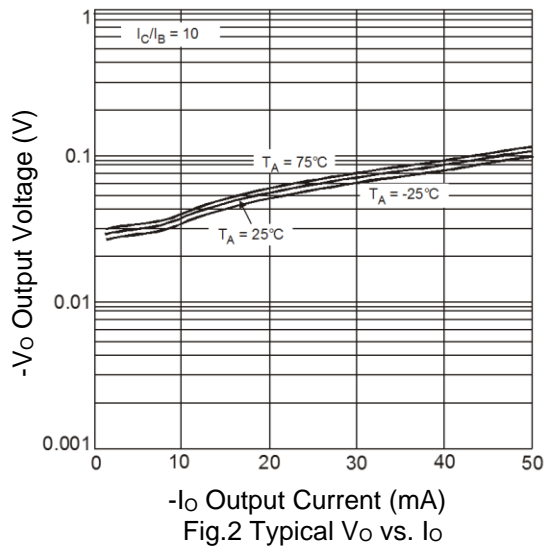



DCX (XXXX) U

Typical Curves – DCX123JU NPN Section (@ $T_A = +25^\circ\text{C}$, unless otherwise specified.)

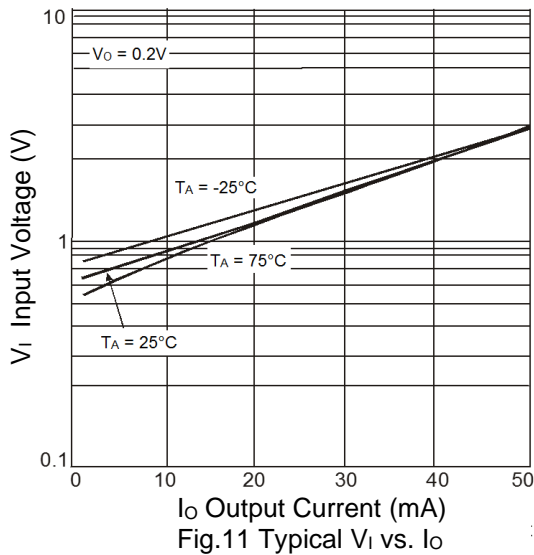
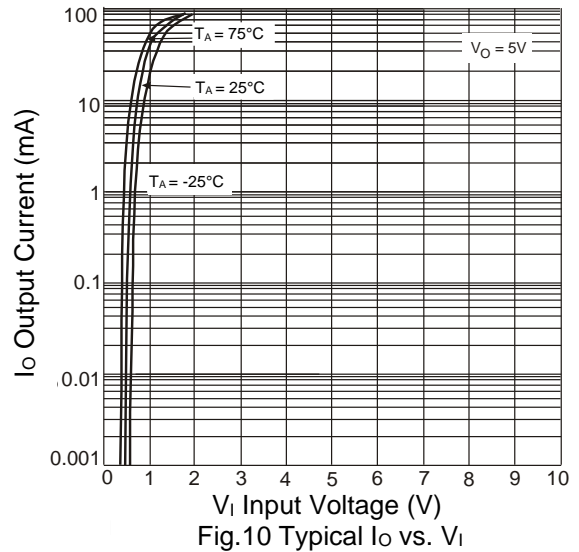
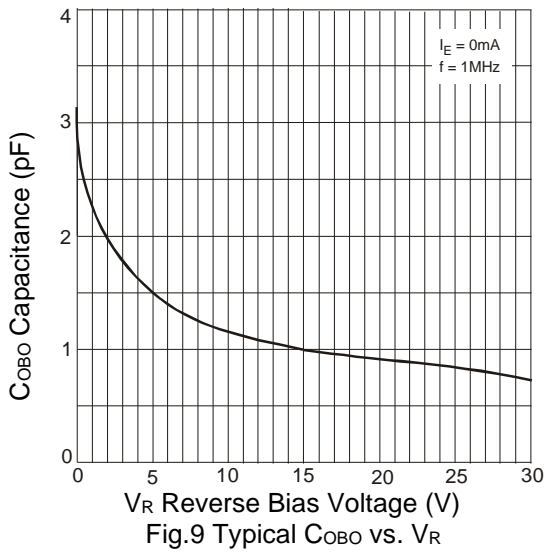
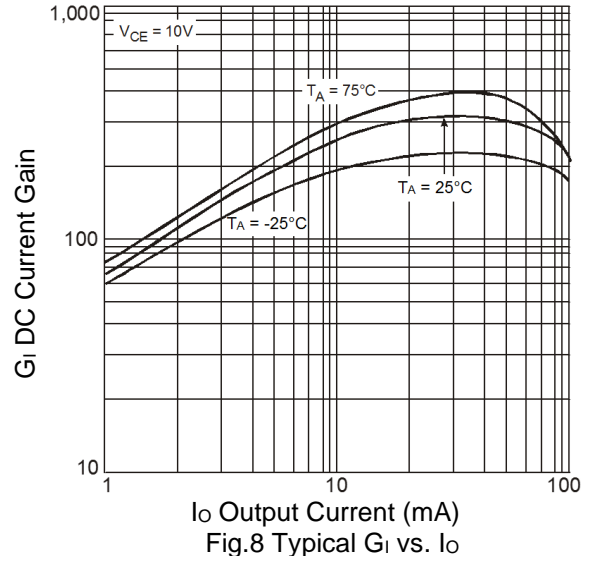
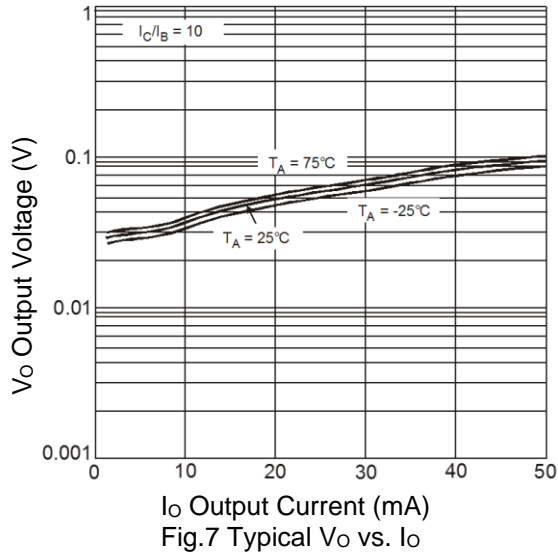



DCX (XXXX) U

Typical Curves – DCX143EU PNP Section (@ $T_A = +25^\circ\text{C}$, unless otherwise specified.)

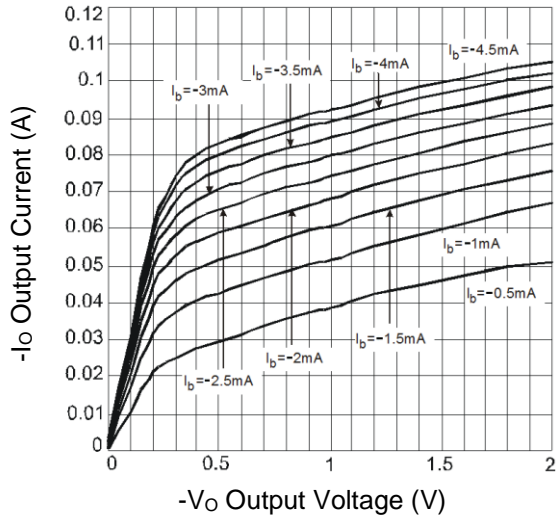

Fig.12 Typical I_o vs. V_o

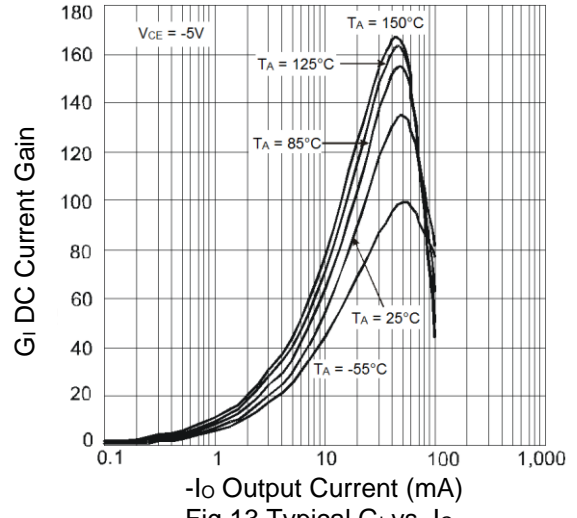

Fig.13 Typical G_i vs. I_o

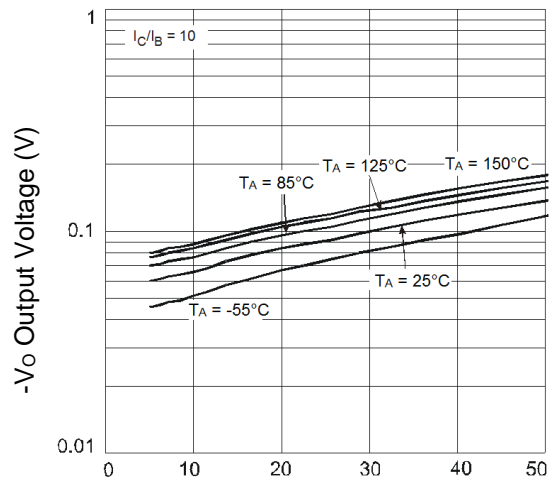

Fig.14 Typical V_o vs. I_o

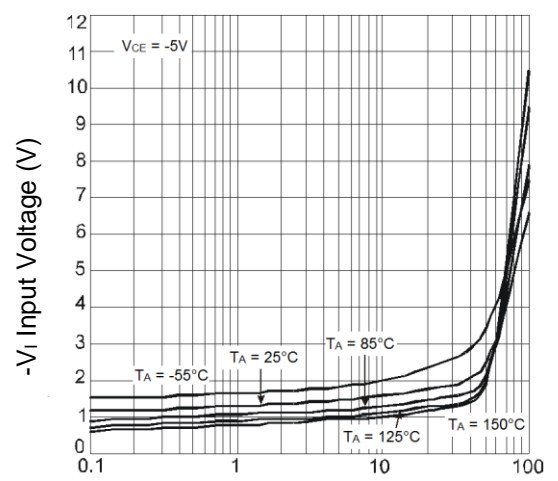

Fig.15 Typical V_i vs. I_o

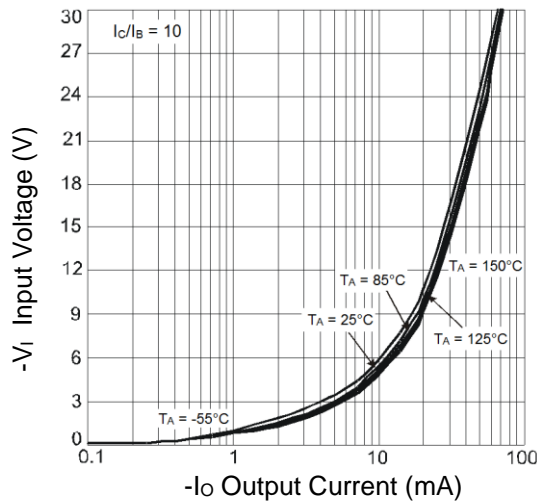

Fig.16 Typical V_i vs. I_o

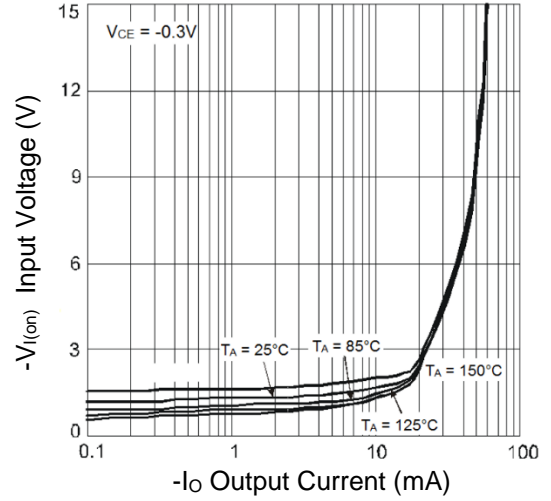
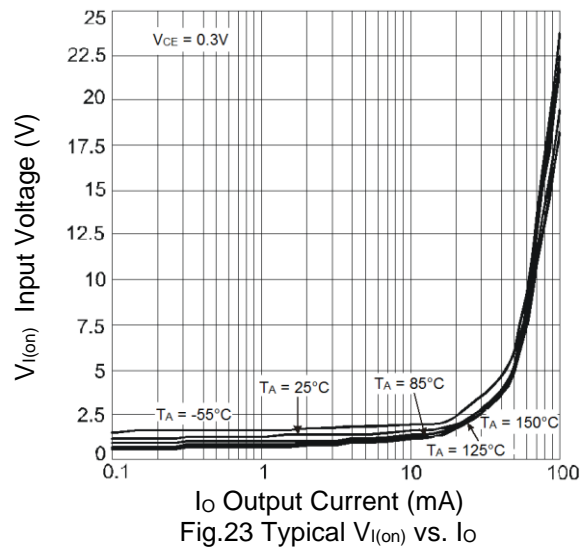
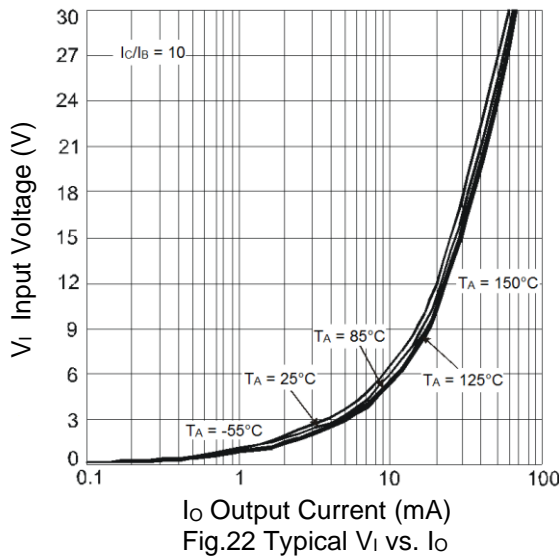
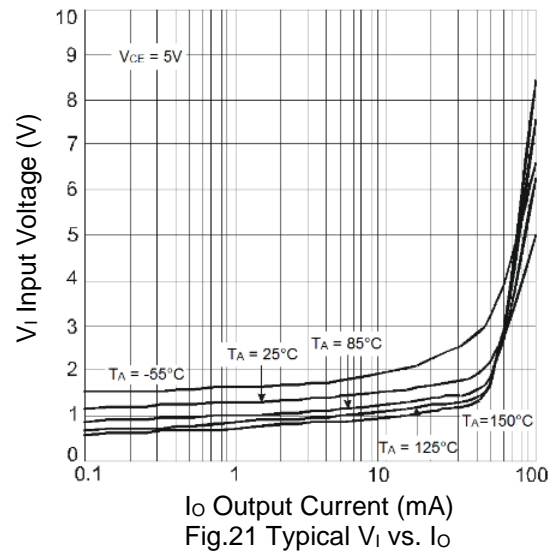
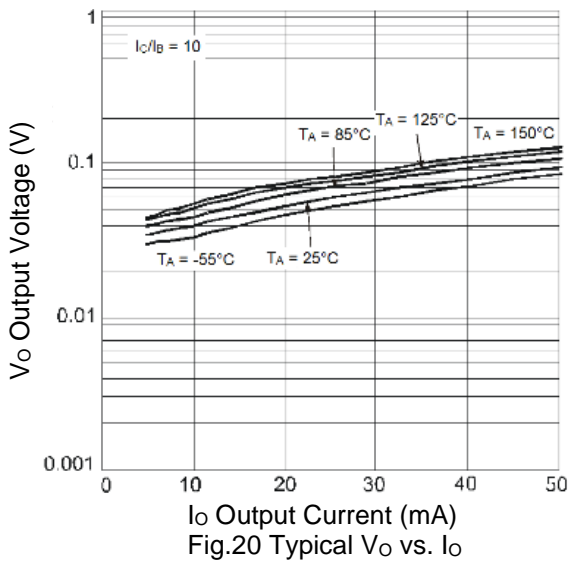
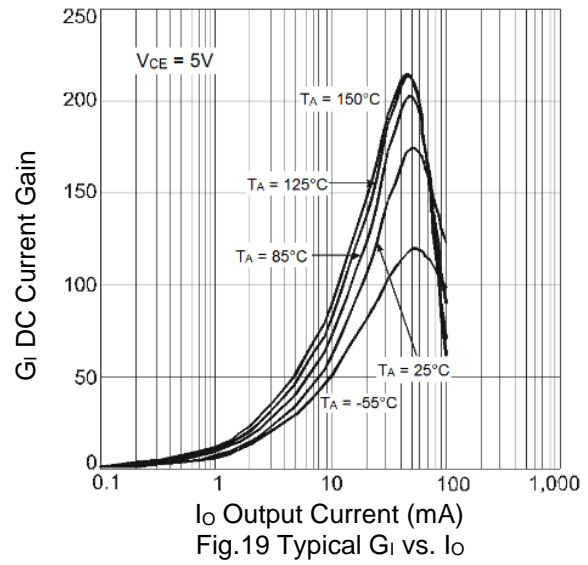
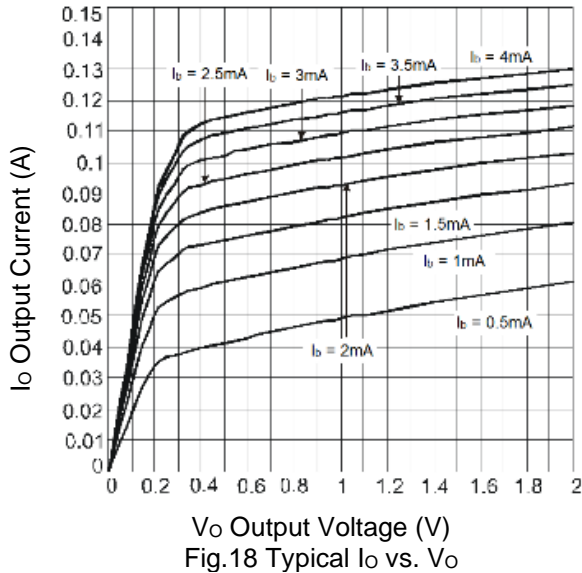

Fig.17 Typical $V_{i(on)}$ vs. I_o



DCX (XXXX) U

Typical Curves – DCX143EU NPN Section (@ $T_A = +25^\circ\text{C}$, unless otherwise specified.)





DCX (XXXX) U

Typical Curves – DCX114TU PNP Section (@ $T_A = +25^\circ\text{C}$, unless otherwise specified.)

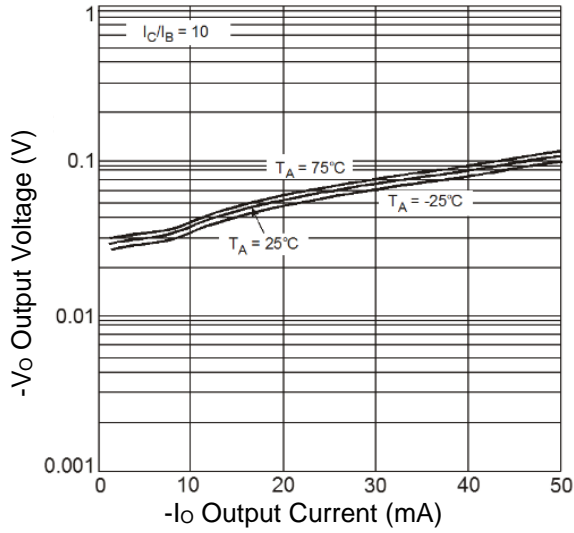

Fig.24 Typical V_O vs. I_o

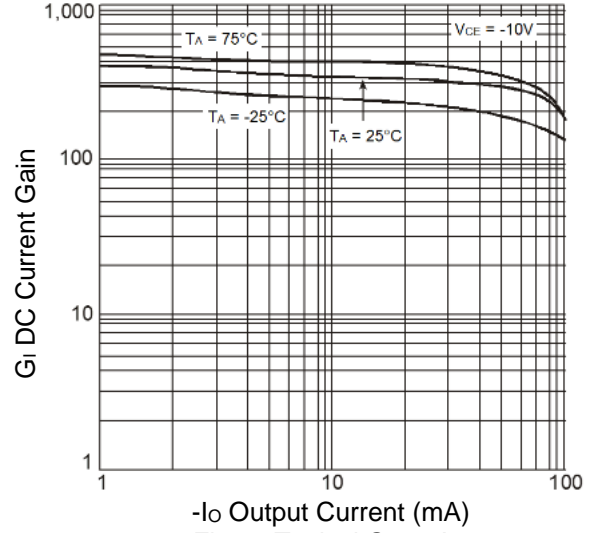

Fig.25 Typical G_I vs. I_o

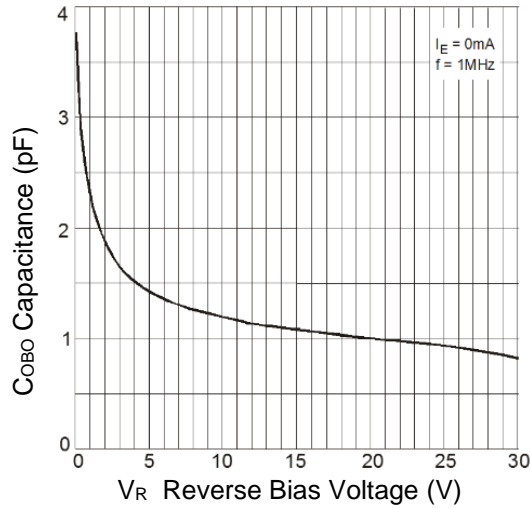

Fig.26 Typical C_{OBO} vs. V_R

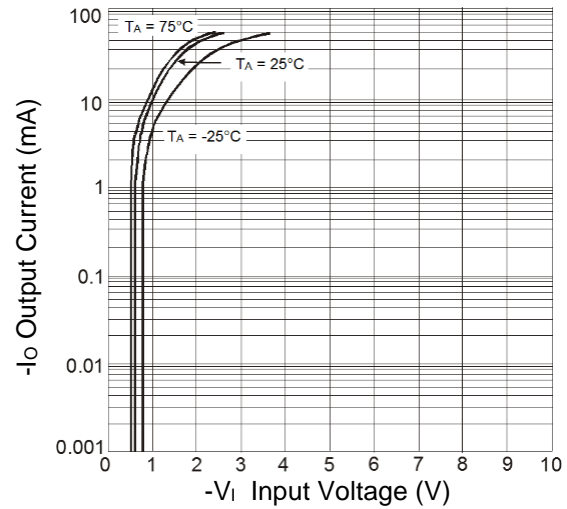

Fig.27 Typical I_o vs. V_I

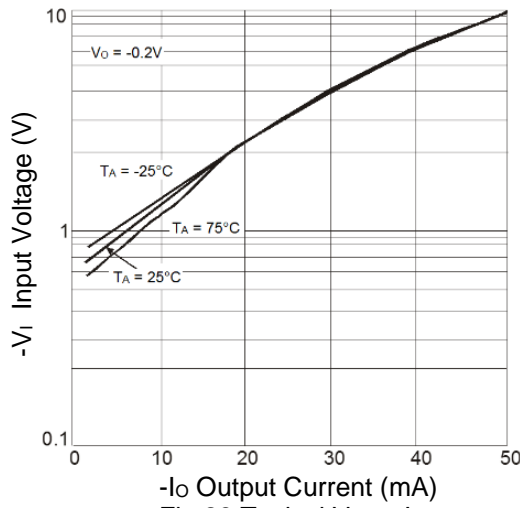
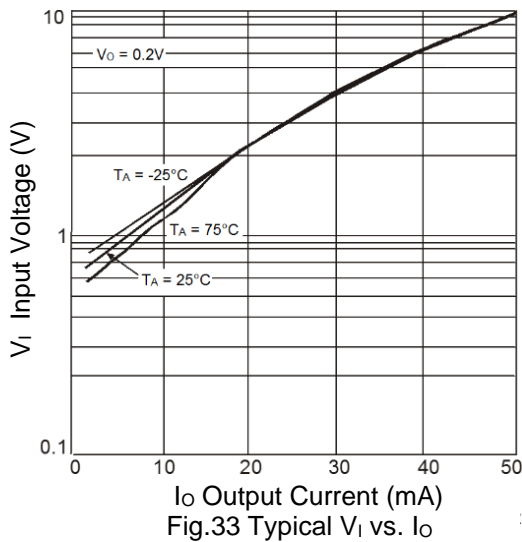
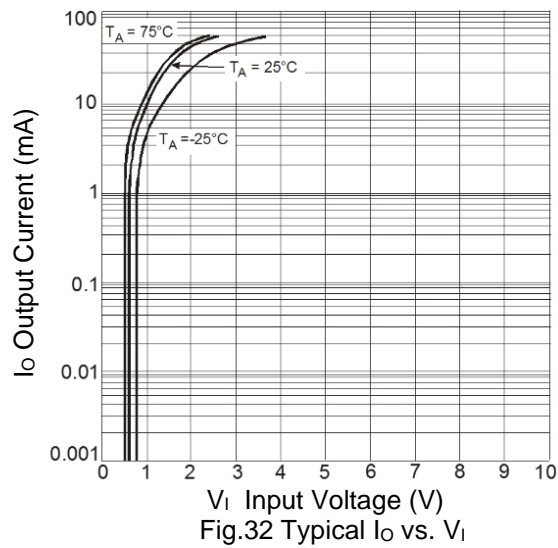
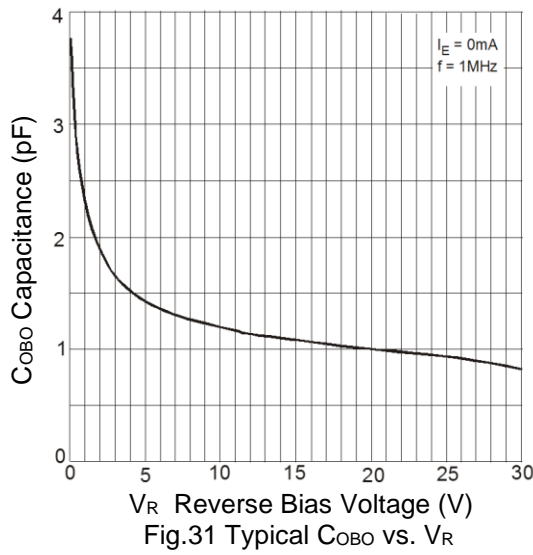
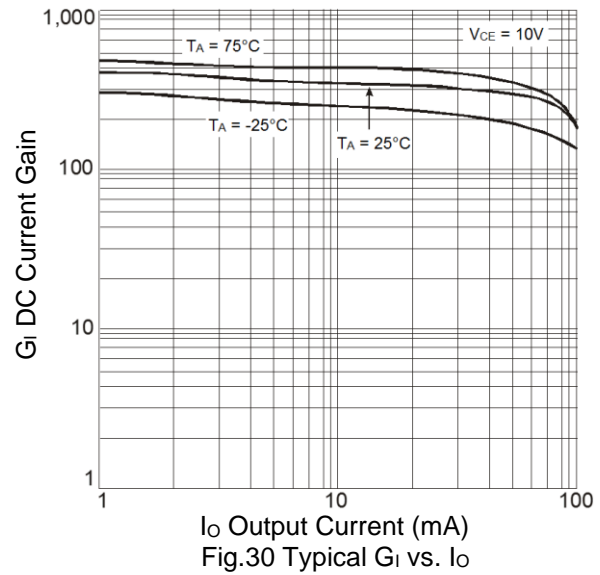
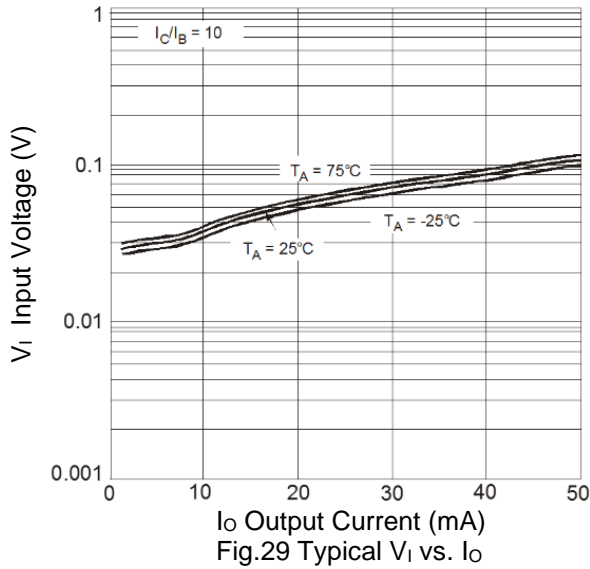

Fig.28 Typical V_I vs. I_o



DCX (XXXX) U

Typical Curves – DCX114TU NPN Section (@ $T_A = +25^\circ\text{C}$, unless otherwise specified.)



Package Outline Dimensions

Please see <http://www.diodes.com/package-outlines.html> for the latest version.

SOT363

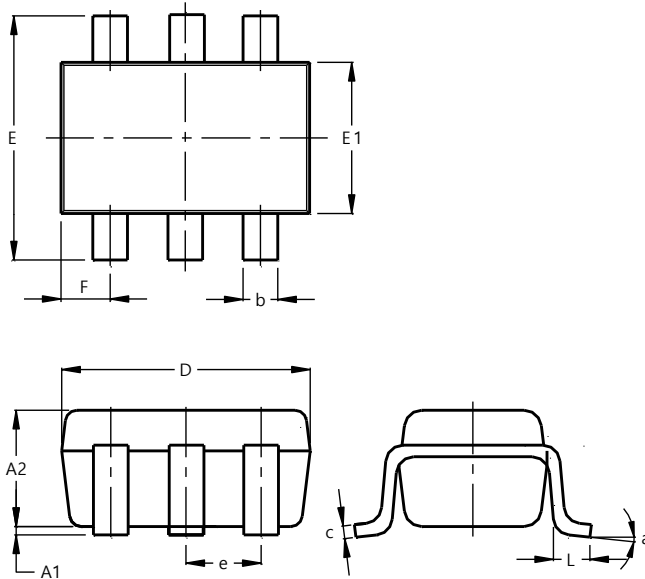

SOT363			
Dim	Min	Max	Typ
A1	0.00	0.10	0.05
A2	0.90	1.00	0.95
b	0.10	0.30	0.25
c	0.10	0.22	0.11
D	1.80	2.20	2.15
E	2.00	2.20	2.10
E1	1.15	1.35	1.30
e	0.650 BSC		
F	0.40	0.45	0.425
L	0.25	0.40	0.30
a	0°	8°	--
All Dimensions in mm			

Suggested Pad Layout

Please see <http://www.diodes.com/package-outlines.html> for the latest version.

SOT363

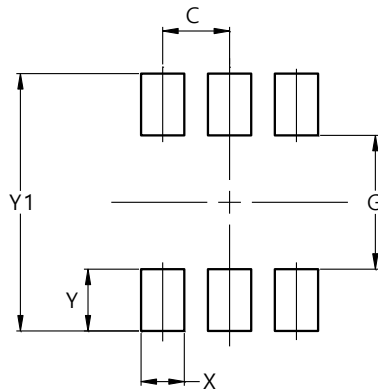

Dimensions	Value (in mm)
C	0.650
G	1.300
X	0.420
Y	0.600
Y1	2.500

**IMPORTANT NOTICE**

1. DIODES INCORPORATED (Diodes) AND ITS SUBSIDIARIES MAKE NO WARRANTY OF ANY KIND, EXPRESS OR IMPLIED, WITH REGARDS TO ANY INFORMATION CONTAINED IN THIS DOCUMENT, INCLUDING, BUT NOT LIMITED TO, THE IMPLIED WARRANTIES OF MERCHANTABILITY, FITNESS FOR A PARTICULAR PURPOSE OR NON-INFRINGEMENT OF THIRD PARTY INTELLECTUAL PROPERTY RIGHTS (AND THEIR EQUIVALENTS UNDER THE LAWS OF ANY JURISDICTION).
2. The Information contained herein is for informational purpose only and is provided only to illustrate the operation of Diodes' products described herein and application examples. Diodes does not assume any liability arising out of the application or use of this document or any product described herein. This document is intended for skilled and technically trained engineering customers and users who design with Diodes' products. Diodes' products may be used to facilitate safety-related applications; however, in all instances customers and users are responsible for (a) selecting the appropriate Diodes products for their applications, (b) evaluating the suitability of Diodes' products for their intended applications, (c) ensuring their applications, which incorporate Diodes' products, comply the applicable legal and regulatory requirements as well as safety and functional-safety related standards, and (d) ensuring they design with appropriate safeguards (including testing, validation, quality control techniques, redundancy, malfunction prevention, and appropriate treatment for aging degradation) to minimize the risks associated with their applications.
3. Diodes assumes no liability for any application-related information, support, assistance or feedback that may be provided by Diodes from time to time. Any customer or user of this document or products described herein will assume all risks and liabilities associated with such use, and will hold Diodes and all companies whose products are represented herein or on Diodes' websites, harmless against all damages and liabilities.
4. Products described herein may be covered by one or more United States, international or foreign patents and pending patent applications. Product names and markings noted herein may also be covered by one or more United States, international or foreign trademarks and trademark applications. Diodes does not convey any license under any of its intellectual property rights or the rights of any third parties (including third parties whose products and services may be described in this document or on Diodes' website) under this document.
5. Diodes' products are provided subject to Diodes' Standard Terms and Conditions of Sale (<https://www.diodes.com/about/company/terms-and-conditions/terms-and-conditions-of-sales/>) or other applicable terms. This document does not alter or expand the applicable warranties provided by Diodes. Diodes does not warrant or accept any liability whatsoever in respect of any products purchased through unauthorized sales channel.
6. Diodes' products and technology may not be used for or incorporated into any products or systems whose manufacture, use or sale is prohibited under any applicable laws and regulations. Should customers or users use Diodes' products in contravention of any applicable laws or regulations, or for any unintended or unauthorized application, customers and users will (a) be solely responsible for any damages, losses or penalties arising in connection therewith or as a result thereof, and (b) indemnify and hold Diodes and its representatives and agents harmless against any and all claims, damages, expenses, and attorney fees arising out of, directly or indirectly, any claim relating to any noncompliance with the applicable laws and regulations, as well as any unintended or unauthorized application.
7. While efforts have been made to ensure the information contained in this document is accurate, complete and current, it may contain technical inaccuracies, omissions and typographical errors. Diodes does not warrant that information contained in this document is error-free and Diodes is under no obligation to update or otherwise correct this information. Notwithstanding the foregoing, Diodes reserves the right to make modifications, enhancements, improvements, corrections or other changes without further notice to this document and any product described herein. This document is written in English but may be translated into multiple languages for reference. Only the English version of this document is the final and determinative format released by Diodes.
8. Any unauthorized copying, modification, distribution, transmission, display or other use of this document (or any portion hereof) is prohibited. Diodes assumes no responsibility for any losses incurred by the customers or users or any third parties arising from any such unauthorized use.
9. This Notice may be periodically updated with the most recent version available at <https://www.diodes.com/about/company/terms-and-conditions/important-notice>

The Diodes logo is a registered trademark of Diodes Incorporated in the United States and other countries.
All other trademarks are the property of their respective owners.
© 2024 Diodes Incorporated. All Rights Reserved.

www.diodes.com

OUR CERTIFICATE

DiGi provide top-quality products and perfect service for customer worldwide through standardization, technological innovation and continuous improvement. DiGi through third-party certification, we stricly control the quality of products and services. Welcome your RFQ to

Email: Info@DiGi-Electronics.com



Tel: +00 852-30501935

RFQ Email: Info@DiGi-Electronics.com

DiGi is a global authorized distributor of electronic components.