

DDTC114EE-7 Datasheet



<https://www.DiGi-Electronics.com>

DiGi Electronics Part Number	DDTC114EE-7-DG
Manufacturer	Diodes Incorporated
Manufacturer Product Number	DDTC114EE-7
Description	TRANS PREBIAS NPN 50V SOT523
Detailed Description	Pre-Biased Bipolar Transistor (BJT) NPN - Pre-Biased 50 V 100 mA 250 MHz 150 mW Surface Mount SOT-523



Tel: +00 852-30501935

RFQ Email: Info@DiGi-Electronics.com

DiGi is a global authorized distributor of electronic components.

Purchase and inquiry

Manufacturer Product Number:

DDTC114EE-7

Series:

-

Transistor Type:

NPN - Pre-Biased

Voltage - Collector Emitter Breakdown (Max):

50 V

Resistor - Emitter Base (R2):

10 kOhms

Vce Saturation (Max) @ Ib, Ic:

300mV @ 500μA, 10mA

Frequency - Transition:

250 MHz

Mounting Type:

Surface Mount

Supplier Device Package:

SOT-523

Manufacturer:

Diodes Incorporated

Product Status:

Discontinued at Digi-Key

Current - Collector (Ic) (Max):

100 mA

Resistor - Base (R1):

10 kOhms

DC Current Gain (hFE) (Min) @ Ic, Vce:

30 @ 5mA, 5V

Current - Collector Cutoff (Max):

500nA

Power - Max:

150 mW

Package / Case:

SOT-523

Base Product Number:

DDTC114

Environmental & Export classification

RoHS Status:

RoHS non-compliant

REACH Status:

REACH Unaffected

HTSUS:

8541.21.0075

Moisture Sensitivity Level (MSL):

1 (Unlimited)

ECCN:

EAR99

Features

- Epitaxial Planar Die Construction
- Complementary PNP Types Available (DDTA)
- Built-In Biasing Resistors, R1 = R2
- **Totally Lead-Free & Fully RoHS Compliant (Notes 1 & 2)**
- **Halogen and Antimony Free. "Green" Device (Note 3)**
- **For automotive applications requiring specific change control (i.e. parts qualified to AEC-Q100/101/200, PPAP capable, and manufactured in IATF 16949 certified facilities), please [contact us](https://www.diodes.com) or your local Diodes representative. <https://www.diodes.com/quality/product-definitions/>**

Mechanical Data

- Case: SOT523
- Case Material: Molded Plastic, "Green" Molding Compound
UL Flammability Classification Rating 94V-0
- Moisture Sensitivity: Level 1 per J-STD-020
- Terminals: Finish – Matte Tin Plated Leads, Solderable per MIL-STD-202, Method 208
- Weight: 0.002 grams (Approximate)

Part Number	R1, R2 (NOM)
DDTC123EE	2.2k Ω
DDTC143EE	4.7k Ω
DDTC114EE	10k Ω
DDTC124EE	22k Ω
DDTC144EE	47k Ω
DDTC115EE	100k Ω

SOT523



Top View

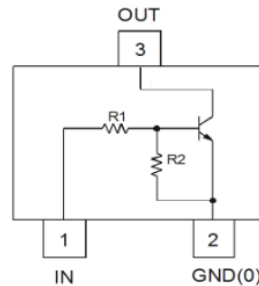

Device Schematic

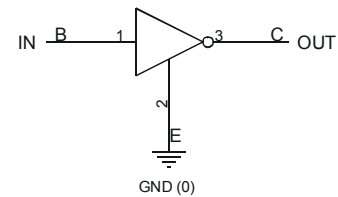

Equivalent Inverter Circuit

Ordering Information (Note 4)

Product	Compliance	Marking	Reel Size (inches)	Tape Width (mm)	Quantity per Reel
DDTC123EE-7-F	Standard	N04	7	8	3000
DDTC143EE-7-F	Standard	N08	7	8	3000
DDTC114EE-7-F	Standard	N13	7	8	3000
DDTC124EE-7-F	Standard	N17	7	8	3000
DDTC144EE-7-F	Standard	N20	7	8	3000
DDTC115EE-7-F	Standard	N24	7	8	3000

- Notes:
1. No purposely added lead. Fully EU Directive 2002/95/EC (RoHS), 2011/65/EU (RoHS 2) & 2015/863/EU (RoHS 3) compliant.
 2. See <https://www.diodes.com/quality/lead-free/> for more information about Diodes Incorporated's definitions of Halogen- and Antimony-free, "Green" and Lead-free.
 3. Halogen- and Antimony-free "Green" products are defined as those which contain <900ppm bromine, <900ppm chlorine (<1500ppm total Br + Cl) and <1000ppm antimony compounds.
 4. For packaging details, go to our website at <https://www.diodes.com/design/support/packaging/diodes-packaging/>.

Marking Information

SOT523

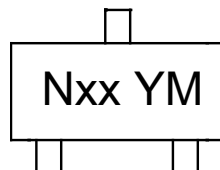

NXX = Product Type Marking Code (See Ordering Information)

YM = Date Code Marking

Y or \bar{Y} = Year (ex: I = 2021)M or \bar{M} = Month (ex: 9 = September)

Date Code Key

Year	2021	2022	2023	2024	2025	2026	2027	2028	2029	2030	2031	2032
Code	I	J	K	L	M	N	O	P	R	S	T	U

Month	Jan	Feb	Mar	Apr	May	Jun	Jul	Aug	Sep	Oct	Nov	Dec
Code	1	2	3	4	5	6	7	8	9	O	N	D

Absolute Maximum Ratings (@ $T_A = +25^\circ\text{C}$, unless otherwise specified.)

Characteristic	Symbol	Value	Unit
Supply Voltage <Pin: (3) to (2)>	V_{CC}	50	V
Input Voltage <Pin: (1) to (2)>	V_i	-10 to +12 -10 to +30 -10 to +40 -10 to +40 -10 to +40 -10 to +40	V
Output Current	I_o	100 100 50 30 100 20	mA
Output Current	I_C (Max)	100	mA

Thermal Characteristics (@ $T_A = +25^\circ\text{C}$, unless otherwise specified.)

Characteristic	Symbol	Value	Unit
Power Dissipation (Notes 5 & 6)	P_D	150	mW
Thermal Resistance, Junction to Ambient Air (Note 5)	$R_{\theta JA}$	833	$^\circ\text{C/W}$
Operating and Storage Temperature Range	T_J, T_{STG}	-55 to +150	$^\circ\text{C}$

Notes: 5. Mounted on FR-4 PC Board with minimum recommended pad layout.

6. 150mW per element must not be exceeded.



DDTC (R1 = R2 SERIES) EE

Electrical Characteristics (@ $T_A = +25^\circ\text{C}$, unless otherwise specified.)

Characteristic		Symbol	Min	Typ	Max	Unit	Test Condition
Input Voltage		$V_{I(off)}$ (Note 7)	0.5	1.1	—	V	$V_{CC} = 5V, I_O = 100\mu\text{A}$ $V_O = 0.3V, I_O = 20\text{mA}$, DDTC123EE $V_O = 0.3V, I_O = 20\text{mA}$, DDTC143EE $V_O = 0.3V, I_O = 10\text{mA}$, DDTC114EE $V_O = 0.3V, I_O = 5\text{mA}$, DDTC124EE $V_O = 0.3V, I_O = 2\text{mA}$, DDTC144EE $V_O = 0.3V, I_O = 1\text{mA}$, DDTC115EE
		$V_{I(on)}$ (Note 8)	—	1.9	3		
Output Voltage		$V_{O(on)}$	—	0.1	0.3	V	$I_O/I_I = 10\text{mA}/0.5\text{mA}$, DDTC123EE $I_O/I_I = 10\text{mA}/0.5\text{mA}$, DDTC143EE $I_O/I_I = 10\text{mA}/0.5\text{mA}$, DDTC114EE $I_O/I_I = 10\text{mA}/0.5\text{mA}$, DDTC124EE $I_O/I_I = 10\text{mA}/0.5\text{mA}$, DDTC144EE $I_O/I_I = 5\text{mA}/0.25\text{mA}$, DDTC115EE
Input Current	DDTC123EE DDTC143EE DDTC114EE DDTC124EE DDTC144EE DDTC115EE	I_I	—	—	3.8 1.8 0.88 0.36 0.18 0.15	mA	$V_I = 5V$
Output Current		$I_{O(off)}$	—	—	0.5	μA	$V_{CC} = 50V, V_I = 0V$
DC Current Gain	DDTC123EE DDTC143EE DDTC114EE DDTC124EE DDTC144EE DDTC115EE	G_I	20 20 30 56 68 82	—	—	—	$V_O = 5V, I_O = 20\text{mA}$ $V_O = 5V, I_O = 10\text{mA}$ $V_O = 5V, I_O = 5\text{mA}$ $V_O = 5V, I_O = 5\text{mA}$ $V_O = 5V, I_O = 5\text{mA}$ $V_O = 5V, I_O = 5\text{mA}$
Input Resistor Tolerance		ΔR_1	-30	—	+30	%	—
Resistance Ratio Tolerance		$\Delta R_2/R_1$	0.8	1	1.2	%	—
Transition frequency (Note 9)		f_T	—	250	—	MHz	$V_{CE} = -10V, I_E = 5\text{mA}$, $f = 100\text{MHz}$

Notes: 7. Guarantees that the device will be switched OFF if the Input Voltage is less than 0.5V.
8. Guarantees that the device will be switched ON if the Input Voltage is more than 3V.
9. Transistor only.

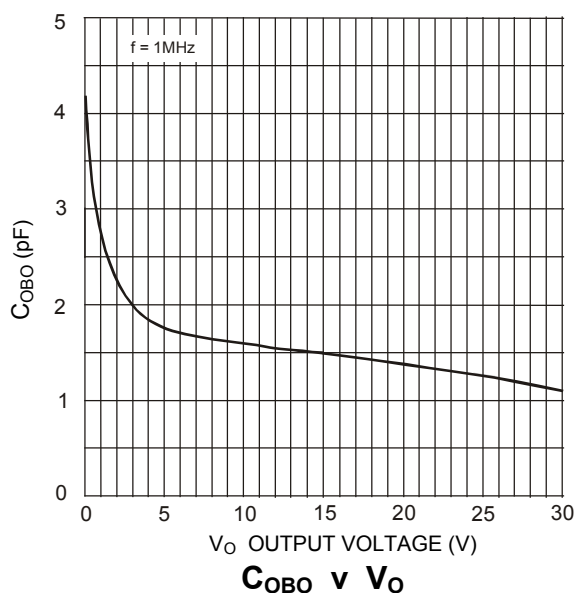
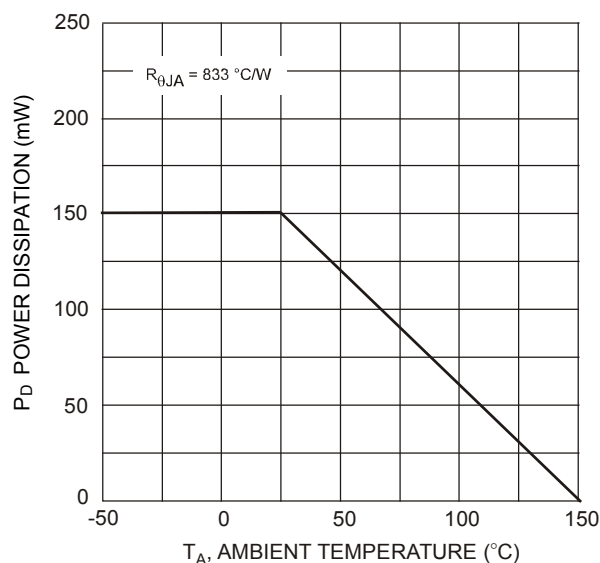
Typical Electrical Characteristics



DDTC (R1 = R2 SERIES) EE

Typical Electrical Characteristics – DDTC123EE

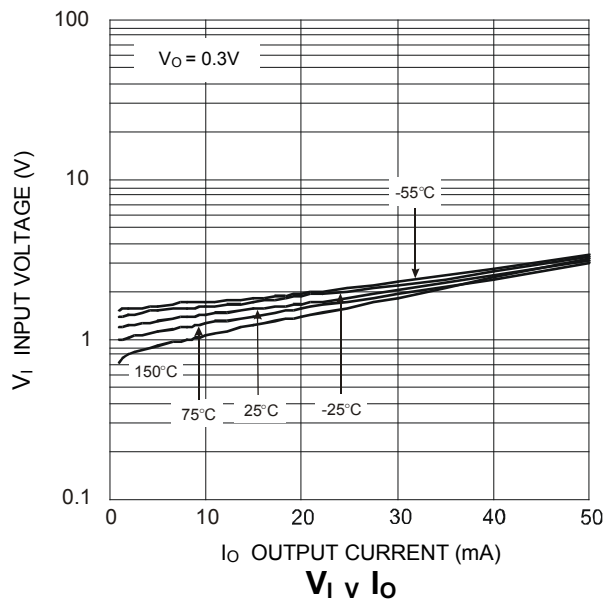
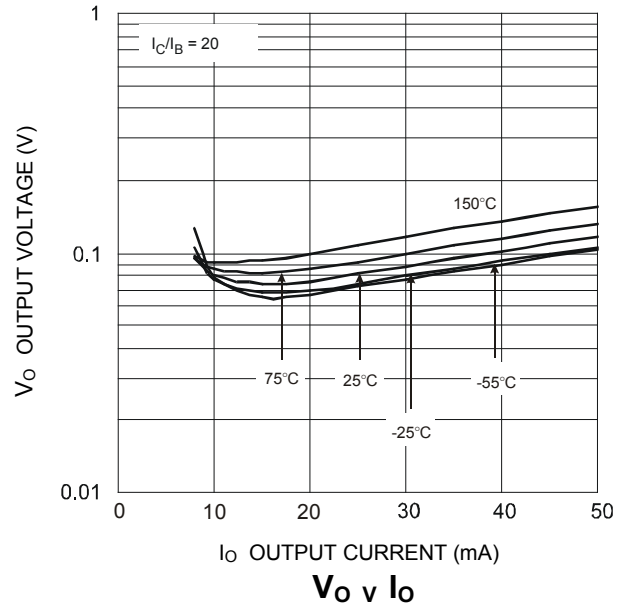
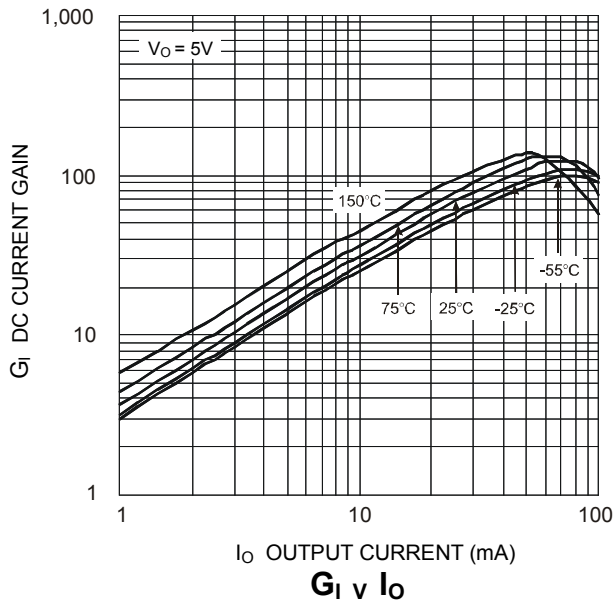



DDTC (R1 = R2 SERIES) EE

Typical Electrical Characteristics – DDTC143EE

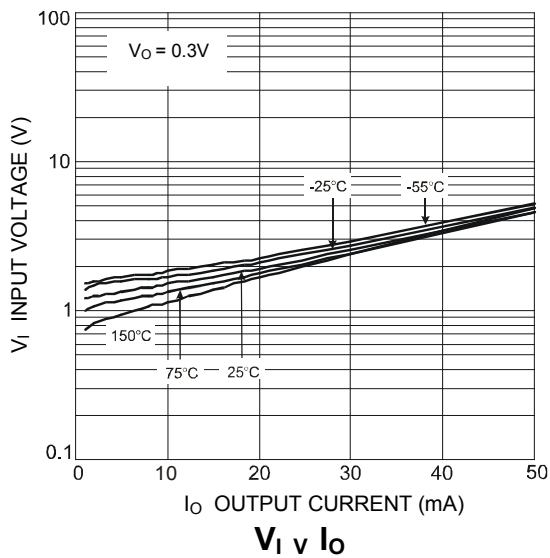
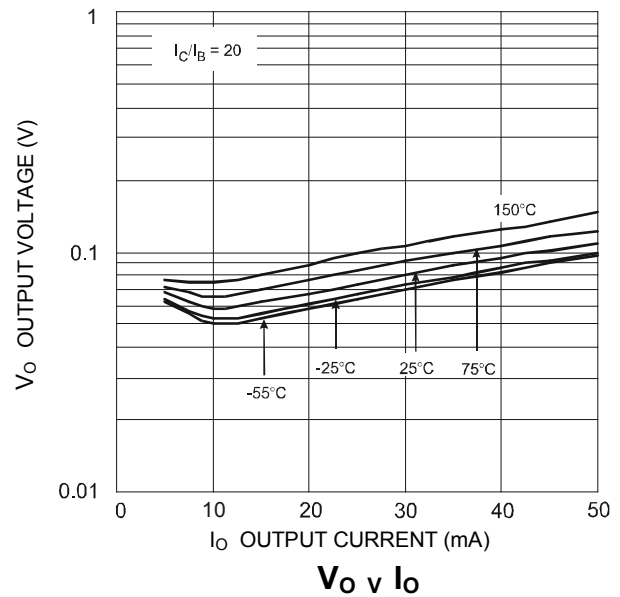
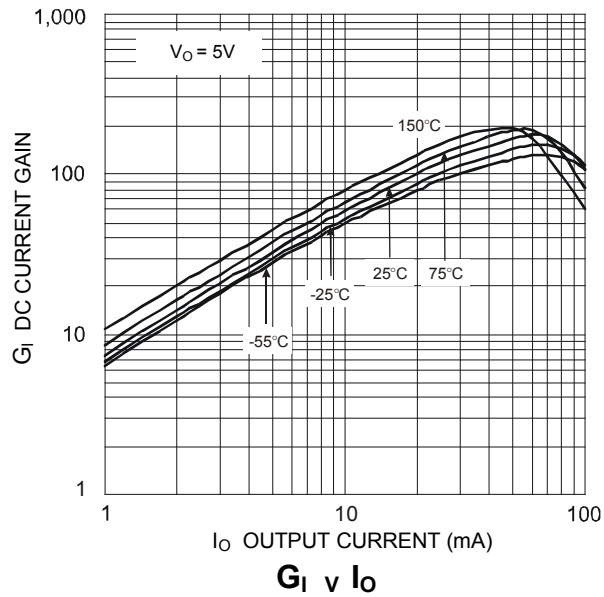



DDTC (R1 = R2 SERIES) EE

Typical Electrical Characteristics – DDTC114EE

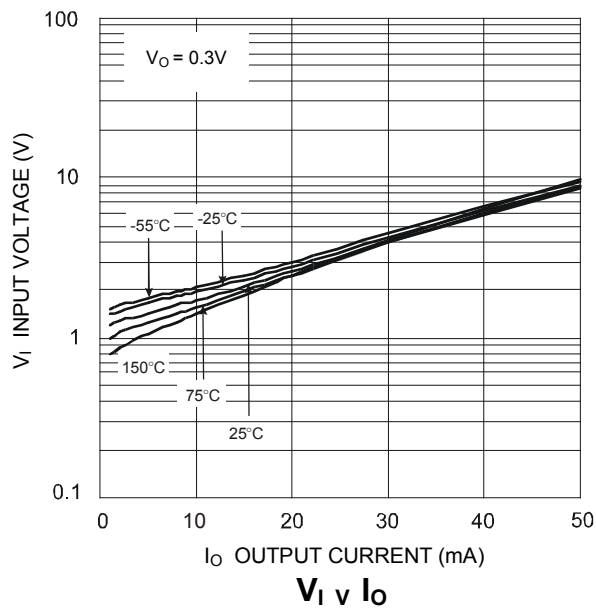
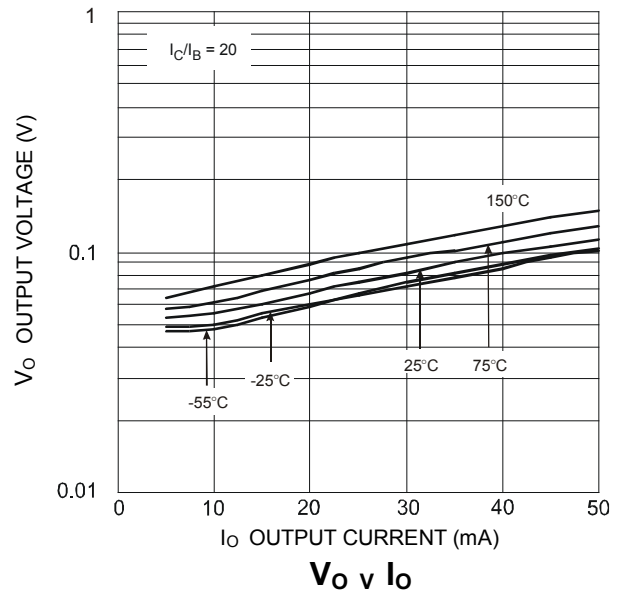
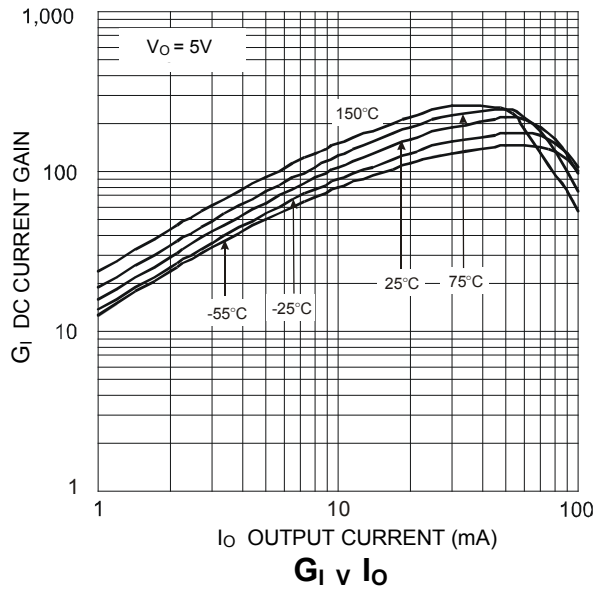



DDTC (R1 = R2 SERIES) EE

Typical Electrical Characteristics – DDTC124EE

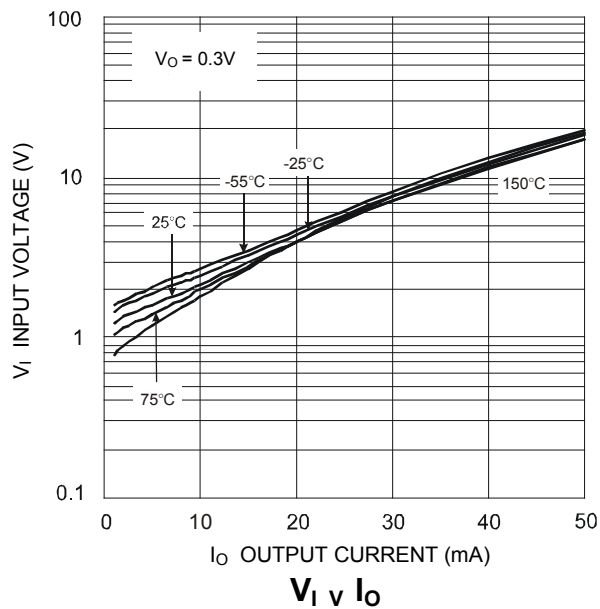
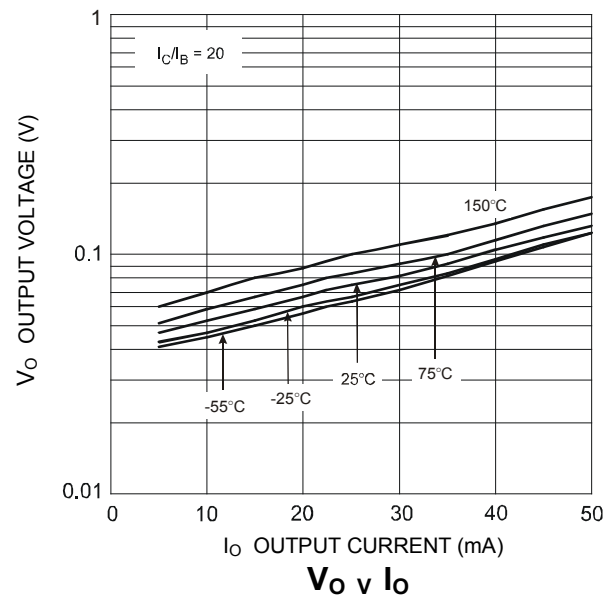
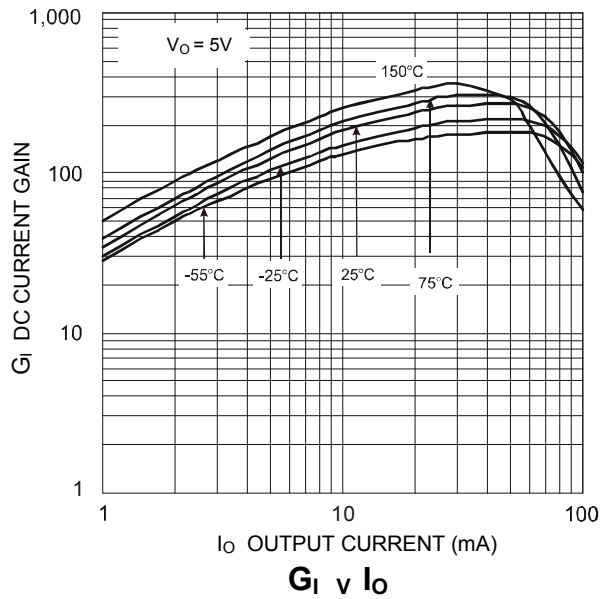



DDTC (R1 = R2 SERIES) EE

Typical Electrical Characteristics – DDTC144EE

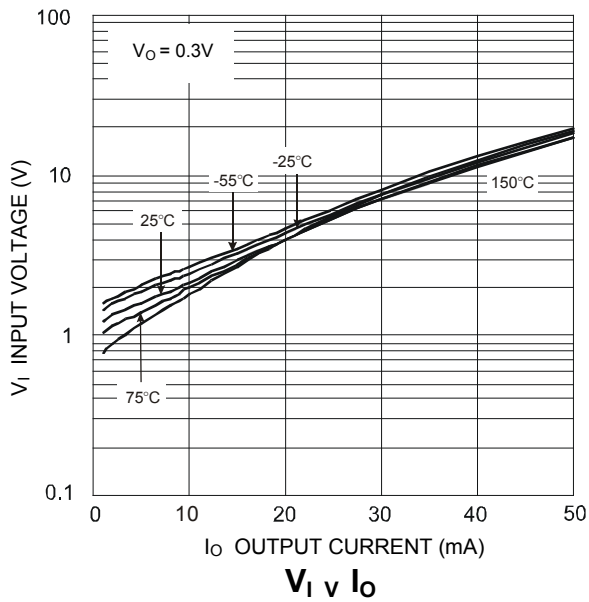
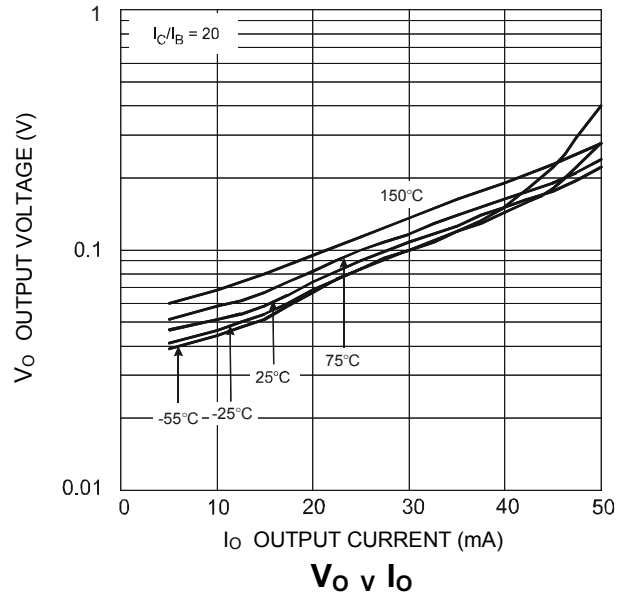
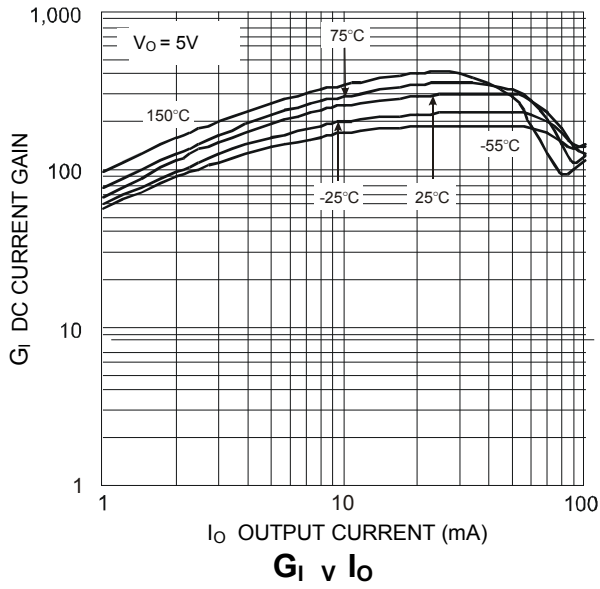

Package Outline Dimensions

Please see <http://www.diodes.com/package-outlines.html> for the latest version.

SOT523

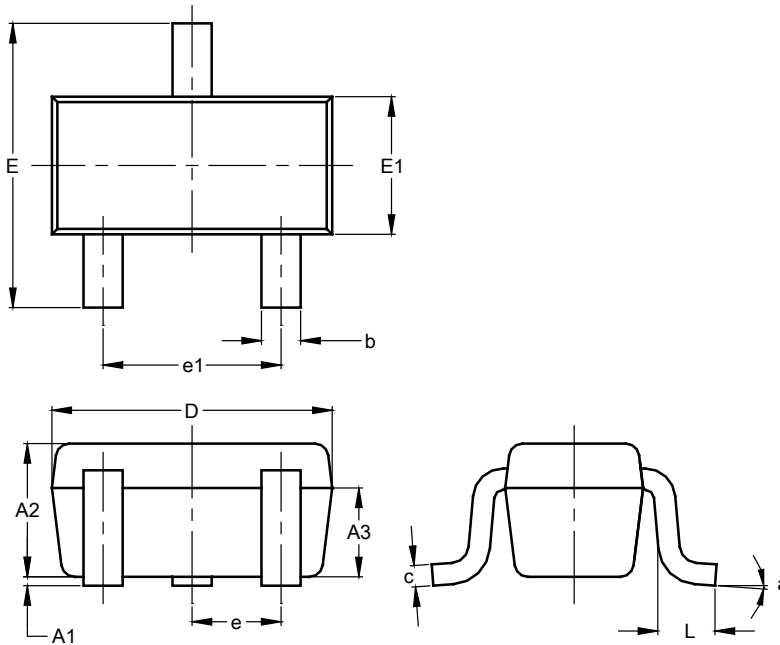

SOT523			
Dim	Min	Max	Typ
A1	0.00	0.10	0.05
A2	0.60	0.80	0.75
A3	0.45	0.65	0.50
b	0.15	0.30	0.22
c	0.10	0.20	0.12
D	1.50	1.70	1.60
E	1.45	1.75	1.60
E1	0.75	0.85	0.80
e	0.50 BSC		
e1	0.90	1.10	1.00
L	0.20	0.40	0.33
a	0°	--	8°
All Dimensions in mm			

Suggested Pad Layout

Please see <http://www.diodes.com/package-outlines.html> for the latest version.

SOT523

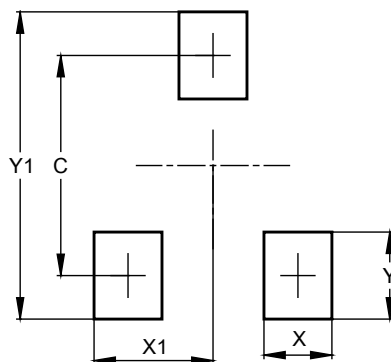

Dimensions	Value (in mm)
C	1.29
X	0.40
X1	0.70
Y	0.51
Y1	1.80

**IMPORTANT NOTICE**

1. DIODES INCORPORATED AND ITS SUBSIDIARIES ("DIODES") MAKE NO WARRANTY OF ANY KIND, EXPRESS OR IMPLIED, WITH REGARDS TO ANY INFORMATION CONTAINED IN THIS DOCUMENT, INCLUDING, BUT NOT LIMITED TO, THE IMPLIED WARRANTIES OF MERCHANTABILITY, FITNESS FOR A PARTICULAR PURPOSE OR NON-INFRINGEMENT OF THIRD PARTY INTELLECTUAL PROPERTY RIGHTS (AND THEIR EQUIVALENTS UNDER THE LAWS OF ANY JURISDICTION).
2. The Information contained herein is for informational purpose only and is provided only to illustrate the operation of Diodes products described herein and application examples. Diodes does not assume any liability arising out of the application or use of this document or any product described herein. This document is intended for skilled and technically trained engineering customers and users who design with Diodes products. Diodes products may be used to facilitate safety-related applications; however, in all instances customers and users are responsible for (a) selecting the appropriate Diodes products for their applications, (b) evaluating the suitability of the Diodes products for their intended applications, (c) ensuring their applications, which incorporate Diodes products, comply the applicable legal and regulatory requirements as well as safety and functional-safety related standards, and (d) ensuring they design with appropriate safeguards (including testing, validation, quality control techniques, redundancy, malfunction prevention, and appropriate treatment for aging degradation) to minimize the risks associated with their applications.
3. Diodes assumes no liability for any application-related information, support, assistance or feedback that may be provided by Diodes from time to time. Any customer or user of this document or products described herein will assume all risks and liabilities associated with such use, and will hold Diodes and all companies whose products are represented herein or on Diodes' websites, harmless against all damages and liabilities.
4. Products described herein may be covered by one or more United States, international or foreign patents and pending patent applications. Product names and markings noted herein may also be covered by one or more United States, international or foreign trademarks and trademark applications. Diodes does not convey any license under any of its intellectual property rights or the rights of any third parties (including third parties whose products and services may be described in this document or on Diodes' website) under this document.
5. Diodes products are provided subject to Diodes' Standard Terms and Conditions of Sale (<https://www.diodes.com/about/company/terms-and-conditions/terms-and-conditions-of-sales/>) or other applicable terms. This document does not alter or expand the applicable warranties provided by Diodes. Diodes does not warrant or accept any liability whatsoever in respect of any products purchased through unauthorized sales channel.
6. Diodes products and technology may not be used for or incorporated into any products or systems whose manufacture, use or sale is prohibited under any applicable laws and regulations. Should customers or users use Diodes products in contravention of any applicable laws or regulations, or for any unintended or unauthorized application, customers and users will (a) be solely responsible for any damages, losses or penalties arising in connection therewith or as a result thereof, and (b) indemnify and hold Diodes and its representatives and agents harmless against any and all claims, damages, expenses, and attorney fees arising out of, directly or indirectly, any claim relating to any noncompliance with the applicable laws and regulations, as well as any unintended or unauthorized application.
7. While efforts have been made to ensure the information contained in this document is accurate, complete and current, it may contain technical inaccuracies, omissions and typographical errors. Diodes does not warrant that information contained in this document is error-free and Diodes is under no obligation to update or otherwise correct this information. Notwithstanding the foregoing, Diodes reserves the right to make modifications, enhancements, improvements, corrections or other changes without further notice to this document and any product described herein. This document is written in English but may be translated into multiple languages for reference. Only the English version of this document is the final and determinative format released by Diodes.
8. Any unauthorized copying, modification, distribution, transmission, display or other use of this document (or any portion hereof) is prohibited. Diodes assumes no responsibility for any losses incurred by the customers or users or any third parties arising from any such unauthorized use.

Copyright © 2021 Diodes Incorporated

www.diodes.com

OUR CERTIFICATE

DiGi provide top-quality products and perfect service for customer worldwide through standardization, technological innovation and continuous improvement. DiGi through third-party certification, we stricly control the quality of products and services. Welcome your RFQ to

Email: Info@DiGi-Electronics.com



Tel: +00 852-30501935

RFQ Email: Info@DiGi-Electronics.com

DiGi is a global authorized distributor of electronic components.