

DDZ13CSF-7 Datasheet

www.digi-electronics.com

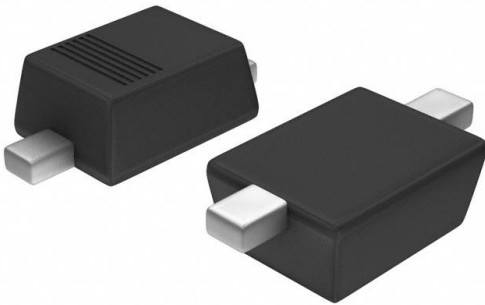

<https://www.DiGi-Electronics.com>

DiGi Electronics Part Number	DDZ13CSF-7-DG
Manufacturer	Diodes Incorporated
Manufacturer Product Number	DDZ13CSF-7
Description	DIODE ZENER 13.33V 500MW SOD323F
Detailed Description	Zener Diode 13.33 V 500 mW ±3% Surface Mount SO D-323F

This model DDZ13CSF-7 is available at DiGi Electronics.

DiGi Electronics offers a global database of semiconductor and electronic component datasheets.

We welcome your inquiries regarding pricing, lead time, or other product-related questions.

 [Request a Quote](#)

 [Datasheet Search](#)



Tel: +00 852-30501935

RFQ Email: Info@DiGi-Electronics.com

DiGi is a global authorized distributor of electronic components.

Purchase and inquiry

Manufacturer Product Number:

DDZ13CSF-7

Series:

-

Voltage - Zener (Nom) (Vz):

13.33 V

Power - Max:

500 mW

Current - Reverse Leakage @ Vr:

70 nA @ 12.3 V

Operating Temperature:

-65°C ~ 150°C

Package / Case:

SC-90, SOD-323F

Base Product Number:

DDZ13

Manufacturer:

Diodes Incorporated

Product Status:

Active

Tolerance:

±3%

Impedance (Max) (Zzt):

35 Ohms

Voltage - Forward (Vf) (Max) @ If:

900 mV @ 10 mA

Mounting Type:

Surface Mount

Supplier Device Package:

SOD-323F

Environmental & Export classification

RoHS Status:

ROHS3 Compliant

REACH Status:

REACH Unaffected

HTSUS:

8541.10.0050

Moisture Sensitivity Level (MSL):

1 (Unlimited)

ECCN:

EAR99



DDZ2V4ASF – DDZ39DSF

0.5W SURFACE-MOUNT PRECISION ZENER DIODE

Features

- 500mW Power Dissipation on FR-4 PCB
- Very Tight Tolerance on V_Z
- Ideally Suited for Automated Assembly Processes
- **Totally Lead-Free & Fully RoHS Compliant (Notes 1 & 2)**
- **Halogen and Antimony Free. "Green" Device (Note 3)**
- **For automotive applications requiring specific change control (i.e. parts qualified to AEC-Q100/101/104/200, PPAP capable, and manufactured in IATF 16949 certified facilities), please [contact us](mailto:contact@diodes.com) or your local Diodes representative. <https://www.diodes.com/quality/product-definitions/>**

Mechanical Data

- Package: SOD323F
- Package Material: Molded Plastic, "Green Molding Compound". UL Flammability Classification Rating 94V-0
- Moisture Sensitivity: Level 1 per J-STD-020
- Terminal Connections: Cathode Band
- Terminals: Finish – Matte Tin Annealed over Copper Alloy Leadframe. Solderable per MIL-STD-202, Method 208 (E3)
- Weight: 0.004 grams (Approximate)

SOD323F



Top View

Ordering Information (Note 4)

Orderable Part Number	Package	Packing	
		Qty.	Carrier
DDZxx(x)xF-7*	SOD323F	3,000	Tape & Reel

*Add "-7" to the appropriate type number in *Electrical Characteristics* table on pages 2 & 3. Example: DDZ10BSF-7.

- Notes:
1. No purposely added lead. Fully EU Directive 2002/95/EC (RoHS), 2011/65/EU (RoHS 2) & 2015/863/EU (RoHS 3) compliant.
 2. See <https://www.diodes.com/quality/lead-free/> for more information about Diodes Incorporated's definitions of Halogen- and Antimony-free, "Green" and Lead-free.
 3. Halogen- and Antimony-free "Green" products are defined as those which contain <900ppm bromine, <900ppm chlorine (<1500ppm total Br + Cl) and <1000ppm antimony compounds.
 4. For packaging details, go to our website at <https://www.diodes.com/design/support/packaging/diodes-packaging/>.

Marking Information

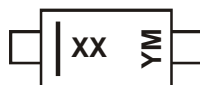

XX = Product Type Marking Code
(See *Electrical Characteristics* Table)
YM = Date Code Marking
Y = Year (ex: L = 2024)
M = Month (ex: 9 = September)

Date Code Key

Year	2010	-	2024	2025	2026	2027	2028	2029	2030	2031	2032	2033
Code	X	-	L	M	N	P	R	S	T	U	V	W

Month	Jan	Feb	Mar	Apr	May	Jun	Jul	Aug	Sep	Oct	Nov	Dec
Code	1	2	3	4	5	6	7	8	9	O	N	D



DDZ2V4ASF – DDZ39DSF

Maximum Ratings (@T_A = +25°C, unless otherwise specified.)

Characteristic	Symbol	Value	Unit
Forward Voltage @ I _F = 10mA	V _F	0.9	V

Thermal Characteristics

Characteristic	Symbol	Value	Unit
Maximum Power Dissipation (Note 5)	P _D	500	mW
Thermal Resistance, Junction to Ambient Air (Note 5)	R _{θJA}	250	°C/W
Operating and Storage Temperature Range	T _J , T _{STG}	-65 to +150	°C

Electrical Characteristics (@T_A = +25°C, unless otherwise specified.)

Type Number	Marking Code	Zener Voltage Range (Note 6)			Maximum Zener Impedance f = 1kHz	Maximum Reverse Current (Note 7)	
		V _Z @ I _{ZT} (V)		I _{ZT} (mA)		Z _{ZT} @ I _{ZT} (Ω)	I _R (μA)
		Min	Max				
DDZ2V4ASF	4C	2.33	2.52	20	100	120	1
DDZ2V4BSF	KD	2.43	2.63	20	100	120	1
DDZ2V7ASF	4E	2.54	2.75	20	110	120	1
DDZ2V7BSF	KE	2.69	2.91	20	110	120	1
DDZ3V0ASF	4F	2.85	3.07	20	120	50	1
DDZ3V0BSF	KF	3.01	3.22	20	120	50	1
DDZ3V3ASF	4G	3.16	3.38	20	130	20	1
DDZ3V3BSF	KG	3.32	3.53	20	130	20	1
DDZ3V6ASF	4H	3.45	3.69	20	130	10	1
DDZ3V6BSF	KH	3.60	3.84	20	130	10	1
DDZ3V9ASF	4J	3.74	4.01	20	130	10	1
DDZ3V9BSF	KJ	3.89	4.16	20	130	10	1
DDZ4V3ASF	4K	4.04	4.29	20	130	10	1
DDZ4V3BSF	KK	4.17	4.43	20	130	10	1
DDZ4V3CSF	YK	4.30	4.57	20	130	10	1
DDZ4V7ASF	4L	4.44	4.68	20	130	10	1
DDZ4V7BSF	KL	4.55	4.80	20	130	10	1
DDZ4V7CSF	YL	4.68	4.93	20	130	10	1
DDZ5V1ASF	4M	4.81	5.07	20	130	7.5	2
DDZ5V1BSF	KM	4.94	5.20	20	130	7.5	2
DDZ5V1CSF	YM	5.09	5.37	20	130	7.5	2
DDZ5V6ASF	4N	5.28	5.55	20	80	7.5	2
DDZ5V6BSF	KN	5.45	5.73	20	80	7.5	2
DDZ5V6CSF	YN	5.61	5.91	20	80	7.5	2
DDZ6V2ASF	4O	5.78	6.09	20	50	7.5	3
DDZ6V2BSF	KO	5.96	6.27	20	50	7.5	3
DDZ6V2CSF	YO	6.12	6.44	20	50	7.5	3
DDZ6V8ASF	4P	6.29	6.63	20	30	7.5	4
DDZ6V8BSF	KP	6.49	6.83	20	30	7.5	4
DDZ6V8CSF	YP	6.66	7.01	20	30	7.5	4
DDZ7V5ASF	4Q	6.85	7.22	20	30	7.5	4
DDZ7V5BSF	KQ	7.07	7.45	20	30	7.5	4
DDZ7V5CSF	YQ	7.29	7.67	20	30	7.5	4
DDZ8V2ASF	4R	7.53	7.92	20	30	7.5	7.15
DDZ8V2BSF	KR	7.78	8.19	20	30	7.5	7.39
DDZ8V2CSF	YR	8.03	8.45	20	30	7.5	7.63

- Notes:
- Device mounted on FR-4 PCB with 10mm x 10mm pad, board size 35mm x 25mm.
 - The zener voltage is measured < 40ms after power is supplied.
 - Short duration pulse test used to minimize self-heating effect.



DDZ2V4ASF – DDZ39DSF

Electrical Characteristics (continued) (@T_A = +25°C, unless otherwise specified.)

Type Number	Marking Code	Zener Voltage Range (Note 6)			Maximum Zener Impedance f = 1kHz	Maximum Reverse Current (Note 7)	
		V _Z @ I _{ZT} (V)		I _{ZT} (mA)		Z _{ZT} @ I _{ZT} (Ω)	I _R (μA)
		Min	Max				
DDZ9V1ASF	4S	8.29	8.73	20	30	7.5	7.88
DDZ9V1BSF	KS	8.57	9.01	20	30	7.5	8.14
DDZ9V1CSF	YS	8.83	9.30	20	30	7.5	8.39
DDZ10ASF	4T	9.12	9.59	20	30	7.5	8.66
DDZ10BSF	KT	9.41	9.90	20	30	7.5	8.94
DDZ10CSF	YT	9.70	10.20	20	30	7.5	9.22
DDZ10DSF	7T	9.94	10.44	20	30	7.5	9.44
DDZ11ASF	4U	10.18	10.71	10	30	0.07	9.67
DDZ11BSF	KU	10.50	11.05	10	30	0.07	9.98
DDZ11CSF	YU	10.82	11.38	10	30	0.07	10.28
DDZ12ASF	4V	11.13	11.71	10	35	0.07	10.60
DDZ12BSF	KV	11.44	12.03	10	30	0.07	10.90
DDZ12CSF	YV	11.74	12.35	10	35	0.07	11.20
DDZ13ASF	4W	12.11	12.75	10	35	0.07	11.50
DDZ13BSF	KW	12.55	13.21	10	35	0.07	11.90
DDZ13CSF	YW	12.99	13.66	10	35	0.07	12.30
DDZ15ASF	4X	13.44	14.13	10	40	0.07	12.80
DDZ15BSF	KX	13.89	14.62	10	40	0.07	13.20
DDZ15CSF	YX	14.35	15.09	10	40	0.07	13.60
DDZ16ASF	4Y	14.80	15.57	10	40	0.07	14.10
DDZ16BSF	KY	15.25	16.04	10	40	0.07	14.50
DDZ16CSF	YY	15.69	16.51	10	40	0.07	14.90
DDZ18ASF	4Z	16.22	17.06	10	45	0.07	15.40
DDZ18BSF	KZ	16.82	17.70	10	45	0.07	16.00
DDZ18CSF	YZ	17.42	18.33	10	45	0.07	16.50
DDZ20ASF	RJ	18.05	18.96	10	50	0.07	17.10
DDZ20BSF	ZJ	18.63	19.59	10	50	0.07	17.70
DDZ20CSF	PJ	19.23	20.22	10	50	0.07	17.70
DDZ20DSF	2J	19.72	20.72	10	50	0.07	18.70
DDZ22ASF	RK	20.15	21.20	5	55	0.07	19.10
DDZ22BSF	ZK	20.64	21.71	5	55	0.07	19.60
DDZ22CSF	PK	21.08	22.17	5	55	0.07	20.00
DDZ22DSF	2K	21.52	22.63	5	55	0.07	20.40
DDZ24ASF	RL	22.05	23.18	5	60	0.07	20.90
DDZ24BSF	ZL	22.61	23.77	5	60	0.07	21.50
DDZ24CSF	PL	23.12	24.31	5	60	0.07	22.00
DDZ24DSF	2L	23.63	24.85	5	60	0.07	22.40
DDZ27ASF	RM	24.26	25.52	5	70	0.07	23.00
DDZ27BSF	ZM	24.97	26.26	5	70	0.07	23.70
DDZ27CSF	PM	25.63	26.95	5	70	0.07	24.30
DDZ27DSF	2M	26.29	27.64	5	70	0.07	25.00
DDZ30ASF	RN	26.99	28.39	5	80	0.07	25.60
DDZ30BSF	ZN	27.70	29.13	5	80	0.07	26.00
DDZ30CSF	PN	28.36	29.82	5	55	0.07	26.90
DDZ30DSF	2N	29.02	30.51	5	80	0.07	27.60
DDZ33ASF	RO	29.68	31.22	5	80	0.07	28.20
DDZ33BSF	ZO	30.32	31.88	5	80	0.07	28.80
DDZ33CSF	PO	30.90	32.50	5	65	0.07	29.40
DDZ33DSF	2O	31.49	33.11	5	65	0.07	29.90
DDZ36ASF	RP	32.14	33.79	5	90	0.07	30.50
DDZ36BSF	ZP	32.79	34.49	5	90	0.07	31.20
DDZ36CSF	PP	33.40	35.13	5	75	0.07	31.70
DDZ36DSF	2P	34.01	35.77	5	90	0.07	32.30
DDZ39ASF	RQ	34.68	36.47	5	85	0.2	30.00
DDZ39BSF	ZQ	35.36	37.19	5	85	0.2	30.00
DDZ39CSF	PQ	36.00	37.85	5	85	0.2	30.00
DDZ39DSF	2Q	36.63	38.52	5	85	0.2	30.00

Notes: 6. The zener voltage is measured < 40ms after power is supplied.
7. Short duration pulse test used to minimize self-heating effect.



DDZ2V4ASF – DDZ39DSF

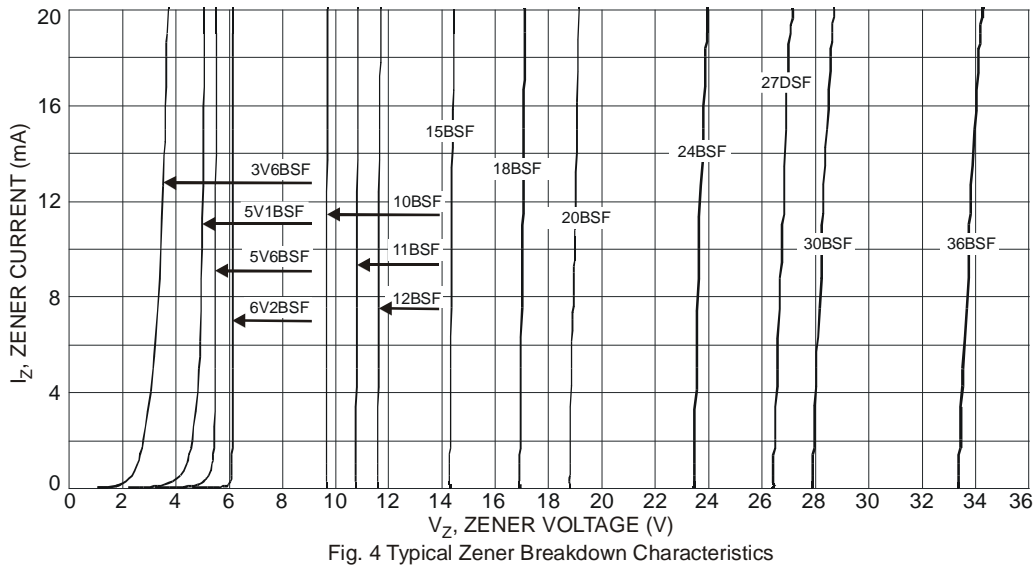
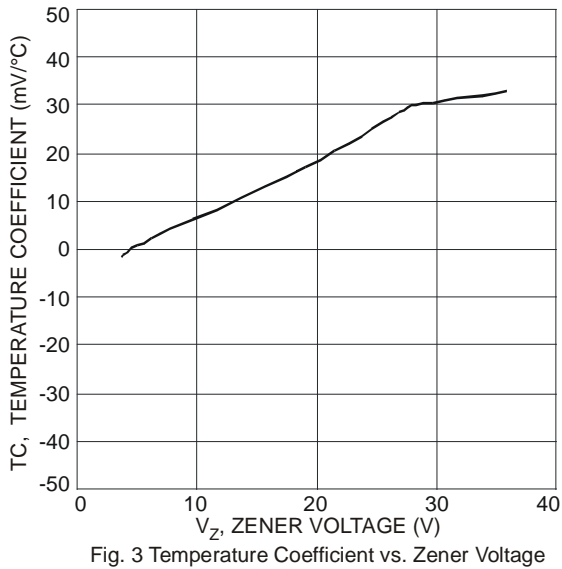
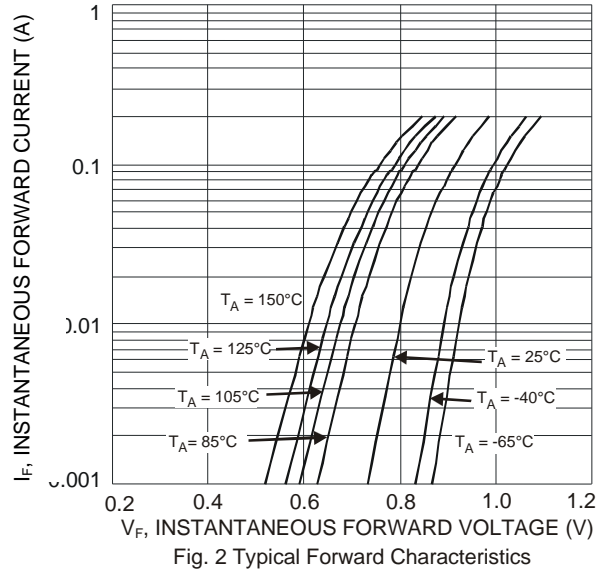
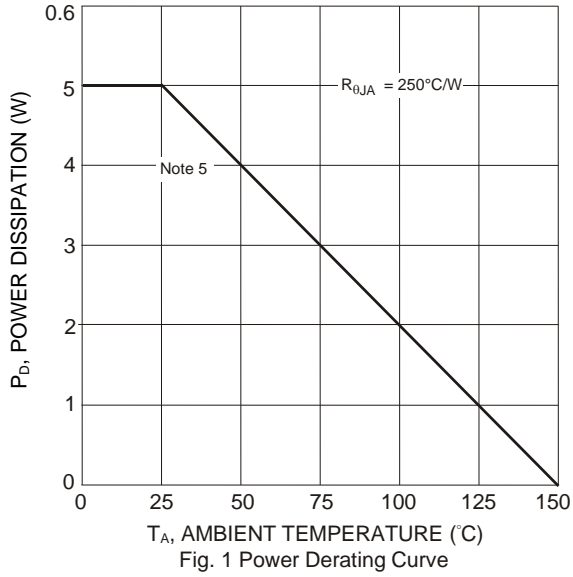

Package Outline Dimensions

Please see <http://www.diodes.com/package-outlines.html> for the latest version.

SOD323F

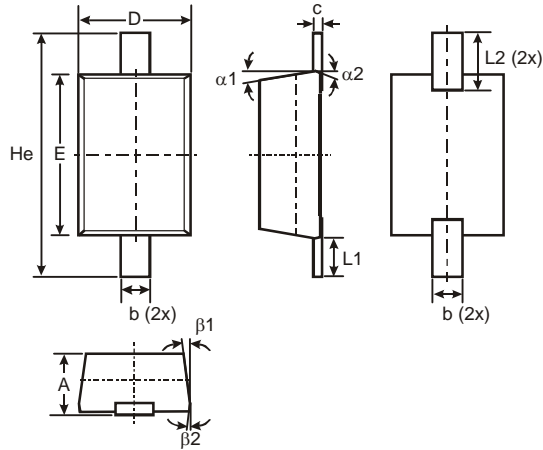

SOD323F			
Dim	Min	Max	Typ
A	0.60	0.75	-
b	0.25	0.35	-
c	0.05	0.26	-
D	1.15	1.35	1.25
E	1.60	1.80	1.70
He	2.30	2.70	2.50
L1	0.30	0.50	0.40
L2	0.41	0.61	0.51
$\alpha 1$	-	-	7°
$\alpha 2$	-	-	3°
$\beta 1$	-	-	7°
$\beta 2$	-	-	3°
All Dimensions in mm			

Suggested Pad Layout

Please see <http://www.diodes.com/package-outlines.html> for the latest version.

SOD323F

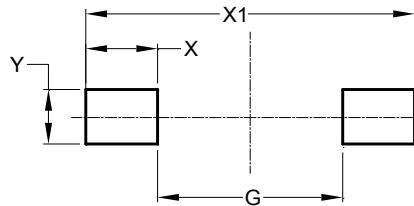

Dimensions	Value (in mm)
G	1.280
X	0.710
X1	2.700
Y	0.403

**IMPORTANT NOTICE**

1. DIODES INCORPORATED (Diodes) AND ITS SUBSIDIARIES MAKE NO WARRANTY OF ANY KIND, EXPRESS OR IMPLIED, WITH REGARDS TO ANY INFORMATION CONTAINED IN THIS DOCUMENT, INCLUDING, BUT NOT LIMITED TO, THE IMPLIED WARRANTIES OF MERCHANTABILITY, FITNESS FOR A PARTICULAR PURPOSE OR NON-INFRINGEMENT OF THIRD PARTY INTELLECTUAL PROPERTY RIGHTS (AND THEIR EQUIVALENTS UNDER THE LAWS OF ANY JURISDICTION).
2. The Information contained herein is for informational purpose only and is provided only to illustrate the operation of Diodes' products described herein and application examples. Diodes does not assume any liability arising out of the application or use of this document or any product described herein. This document is intended for skilled and technically trained engineering customers and users who design with Diodes' products. Diodes' products may be used to facilitate safety-related applications; however, in all instances customers and users are responsible for (a) selecting the appropriate Diodes products for their applications, (b) evaluating the suitability of Diodes' products for their intended applications, (c) ensuring their applications, which incorporate Diodes' products, comply the applicable legal and regulatory requirements as well as safety and functional-safety related standards, and (d) ensuring they design with appropriate safeguards (including testing, validation, quality control techniques, redundancy, malfunction prevention, and appropriate treatment for aging degradation) to minimize the risks associated with their applications.
3. Diodes assumes no liability for any application-related information, support, assistance or feedback that may be provided by Diodes from time to time. Any customer or user of this document or products described herein will assume all risks and liabilities associated with such use, and will hold Diodes and all companies whose products are represented herein or on Diodes' websites, harmless against all damages and liabilities.
4. Products described herein may be covered by one or more United States, international or foreign patents and pending patent applications. Product names and markings noted herein may also be covered by one or more United States, international or foreign trademarks and trademark applications. Diodes does not convey any license under any of its intellectual property rights or the rights of any third parties (including third parties whose products and services may be described in this document or on Diodes' website) under this document.
5. Diodes' products are provided subject to Diodes' Standard Terms and Conditions of Sale (<https://www.diodes.com/about/company/terms-and-conditions/terms-and-conditions-of-sales/>) or other applicable terms. This document does not alter or expand the applicable warranties provided by Diodes. Diodes does not warrant or accept any liability whatsoever in respect of any products purchased through unauthorized sales channel.
6. Diodes' products and technology may not be used for or incorporated into any products or systems whose manufacture, use or sale is prohibited under any applicable laws and regulations. Should customers or users use Diodes' products in contravention of any applicable laws or regulations, or for any unintended or unauthorized application, customers and users will (a) be solely responsible for any damages, losses or penalties arising in connection therewith or as a result thereof, and (b) indemnify and hold Diodes and its representatives and agents harmless against any and all claims, damages, expenses, and attorney fees arising out of, directly or indirectly, any claim relating to any noncompliance with the applicable laws and regulations, as well as any unintended or unauthorized application.
7. While efforts have been made to ensure the information contained in this document is accurate, complete and current, it may contain technical inaccuracies, omissions and typographical errors. Diodes does not warrant that information contained in this document is error-free and Diodes is under no obligation to update or otherwise correct this information. Notwithstanding the foregoing, Diodes reserves the right to make modifications, enhancements, improvements, corrections or other changes without further notice to this document and any product described herein. This document is written in English but may be translated into multiple languages for reference. Only the English version of this document is the final and determinative format released by Diodes.
8. Any unauthorized copying, modification, distribution, transmission, display or other use of this document (or any portion hereof) is prohibited. Diodes assumes no responsibility for any losses incurred by the customers or users or any third parties arising from any such unauthorized use.
9. This Notice may be periodically updated with the most recent version available at <https://www.diodes.com/about/company/terms-and-conditions/important-notice>

The Diodes logo is a registered trademark of Diodes Incorporated in the United States and other countries.
All other trademarks are the property of their respective owners.
© 2024 Diodes Incorporated. All Rights Reserved.

www.diodes.com

OUR CERTIFICATE

DiGi provide top-quality products and perfect service for customer worldwide through standardization, technological innovation and continuous improvement. DiGi through third-party certification, we stricly control the quality of products and services. Welcome your RFQ to

Email: Info@DiGi-Electronics.com



Tel: +00 852-30501935

RFQ Email: Info@DiGi-Electronics.com

DiGi is a global authorized distributor of electronic components.