

# DMG1013UW-7 Datasheet



<https://www.DiGi-Electronics.com>

DiGi Electronics Part Number	DMG1013UW-7-DG
Manufacturer	<a href="#">Diodes Incorporated</a>
Manufacturer Product Number	DMG1013UW-7
Description	MOSFET P-CH 20V 820MA SOT323
Detailed Description	P-Channel 20 V 820mA (Ta) 310mW (Ta) Surface Mount SOT-323



Tel: +00 852-30501935

RFQ Email: [Info@DiGi-Electronics.com](mailto:Info@DiGi-Electronics.com)

DiGi is a global authorized distributor of electronic components.

## Purchase and inquiry

Manufacturer Product Number:

DMG1013UW-7

Series:

-

FET Type:

P-Channel

Drain to Source Voltage (Vdss):

20 V

Drive Voltage (Max Rds On, Min Rds On):

1.8V, 4.5V

Vgs(th) (Max) @ Id:

1V @ 250 $\mu$ A

Vgs (Max):

$\pm$ 6V

FET Feature:

-

Operating Temperature:

-55°C ~ 150°C (Tj)

Supplier Device Package:

SOT-323

Base Product Number:

DMG1013

Manufacturer:

Diodes Incorporated

Product Status:

Active

Technology:

MOSFET (Metal Oxide)

Current - Continuous Drain (Id) @ 25°C:

820mA (Ta)

Rds On (Max) @ Id, Vgs:

750mOhm @ 430mA, 4.5V

Gate Charge (Qg) (Max) @ Vgs:

0.622 nC @ 4.5 V

Input Capacitance (Ciss) (Max) @ Vds:

59.76 pF @ 16 V

Power Dissipation (Max):

310mW (Ta)

Mounting Type:

Surface Mount

Package / Case:

SC-70, SOT-323

## Environmental & Export classification

RoHS Status:

ROHS3 Compliant

REACH Status:

REACH Unaffected

HTSUS:

8541.21.0095

Moisture Sensitivity Level (MSL):

1 (Unlimited)

ECCN:

EAR99





DMG1013UW

## P-CHANNEL ENHANCEMENT MODE MOSFET

## Features

- Low On-Resistance
- Low Gate Threshold Voltage
- Low Input Capacitance
- Fast Switching Speed
- Low Input/Output Leakage
- **ESD Protected**
- **Totally Lead-Free & Fully RoHS compliant (Notes 1 & 2)**
- **Halogen and Antimony Free. "Green" Device (Note 3)**
- **Qualified to AEC-Q101 Standards for High Reliability**

## Mechanical Data

- Case: SOT-323
- Case Material: Molded Plastic, "Green" Molding Compound. UL Flammability Classification Rating 94V-0
- Moisture Sensitivity: Level 1 per J-STD-020
- Terminal Connections: See Diagram Below
- Terminals: Finish - Matte Tin annealed over Alloy 42 leadframe. Solderable per MIL-STD-202, Method 208 (e3)
- Weight: 0.006 grams (approximate)



ESD PROTECTED



Top View

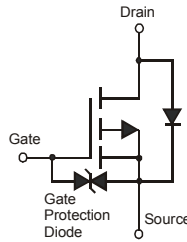

Equivalent Circuit

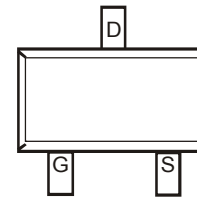

Top View

## Ordering Information (Note 4)

Part Number	Case	Packaging
DMG1013UW-7	SOT-323	3000 / Tape & Reel

- Notes:
1. No purposely added lead. Fully EU Directive 2002/95/EC (RoHS) & 2011/65/EU (RoHS 2) compliant.
  2. See [http://www.diodes.com/quality/lead\\_free.html](http://www.diodes.com/quality/lead_free.html) for more information about Diodes Incorporated's definitions of Halogen- and Antimony-free, "Green" and Lead-free.
  3. Halogen- and Antimony-free "Green" products are defined as those which contain <900ppm bromine, <900ppm chlorine (<1500ppm total Br + Cl) and <1000ppm antimony compounds.
  4. For packaging details, go to our website at <http://www.diodes.com/products/packages.html>

## Marking Information

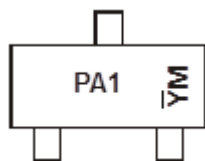

Chengdu A/T Site

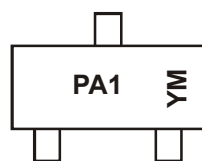

Shanghai A/T Site

PA1 = Product Type Marking Code  
 YM = Date Code Marking for SAT (Shanghai Assembly/ Test site)  
 YM = Date Code Marking for CAT (Chengdu Assembly/ Test site)  
 Y or Ȳ = Year (ex: A = 2013)  
 M = Month (ex: 9 = September)

### Date Code Key

Year	2008	2009	2010	2011	2012	2013	2014	2015
Code	V	W	X	Y	Z	A	B	C

Month	Jan	Feb	Mar	Apr	May	Jun	Jul	Aug	Sep	Oct	Nov	Dec
Code	1	2	3	4	5	6	7	8	9	O	N	D



## Maximum Ratings (@T<sub>A</sub> = +25°C, unless otherwise specified.)

Characteristic			Symbol	Value	Unit
Drain-Source Voltage			V <sub>DSS</sub>	-20	V
Gate-Source Voltage			V <sub>GSS</sub>	±6	V
Continuous Drain Current (Note 5)	Steady State	T <sub>A</sub> = +25°C	I <sub>D</sub>	-0.82	A
		T <sub>A</sub> = +85°C		-0.54	
Pulsed Drain Current (Note 6)			I <sub>DM</sub>	-6	A

## Thermal Characteristics

Characteristic	Symbol	Value	Unit
Power Dissipation (Note 5)	P <sub>D</sub>	0.31	W
Thermal Resistance, Junction to Ambient @T <sub>A</sub> = +25°C (Note 5)	R <sub>θJA</sub>	398	°C/W
Operating and Storage Temperature Range	T <sub>J</sub> , T <sub>STG</sub>	-55 to +150	°C

Notes: 5. Device mounted on FR-4 PCB, with minimum recommended pad layout.  
6. Repetitive rating, pulse width limited by junction temperature.

## Electrical Characteristics (@T<sub>A</sub> = +25°C, unless otherwise specified.)

Characteristic	Symbol	Min	Typ	Max	Unit	Test Condition
<b>OFF CHARACTERISTICS (Note 7)</b>						
Drain-Source Breakdown Voltage	BV <sub>DSS</sub>	-20	-	-	V	V <sub>GS</sub> = 0V, I <sub>D</sub> = -250μA
Zero Gate Voltage Drain Current T <sub>J</sub> = +25°C	I <sub>DSS</sub>	-	-	-100	nA	V <sub>DS</sub> = -20V, V <sub>GS</sub> = 0V
Gate-Source Leakage	I <sub>GSS</sub>	-	-	±2.0	μA	V <sub>GS</sub> = ±4.5V, V <sub>DS</sub> = 0V
<b>ON CHARACTERISTICS (Note 7)</b>						
Gate Threshold Voltage	V <sub>GS(th)</sub>	-0.5	-	-1.0	V	V <sub>DS</sub> = V <sub>GS</sub> , I <sub>D</sub> = -250μA
Static Drain-Source On-Resistance	R <sub>DS(on)</sub>	-	0.5	0.75	Ω	V <sub>GS</sub> = -4.5V, I <sub>D</sub> = -430mA
			0.7	1.05		
			1.0	1.5		
Forward Transfer Admittance	Y <sub>fs</sub>	-	0.9	-	S	V <sub>DS</sub> = -10V, I <sub>D</sub> = -250mA
Diode Forward Voltage	V <sub>SD</sub>	-	-0.8	-1.2	V	V <sub>GS</sub> = 0V, I <sub>S</sub> = -150mA
<b>DYNAMIC CHARACTERISTICS (Note 8)</b>						
Input Capacitance	C <sub>iss</sub>	-	59.76	-	pF	V <sub>DS</sub> = -16V, V <sub>GS</sub> = 0V, f = 1.0MHz
Output Capacitance	C <sub>oss</sub>	-	12.07	-	pF	
Reverse Transfer Capacitance	C <sub>rss</sub>	-	6.36	-	pF	
Total Gate Charge	Q <sub>g</sub>	-	622.4	-	pC	V <sub>GS</sub> = -4.5V, V <sub>DS</sub> = -10V, I <sub>D</sub> = -250mA
Gate-Source Charge	Q <sub>gs</sub>	-	100.3	-	pC	
Gate-Drain Charge	Q <sub>gd</sub>	-	132.2	-	pC	
Turn-On Delay Time	t <sub>D(on)</sub>	-	5.1	-	ns	V <sub>DD</sub> = -10V, V <sub>GS</sub> = -4.5V, R <sub>L</sub> = 47Ω, R <sub>G</sub> = 10Ω, I <sub>D</sub> = -200mA
Turn-On Rise Time	t <sub>r</sub>	-	8.1	-	ns	
Turn-Off Delay Time	t <sub>D(off)</sub>	-	28.4	-	ns	
Turn-Off Fall Time	t <sub>f</sub>	-	20.7	-	ns	

Notes: 7. Short duration pulse test used to minimize self-heating effect.  
8. Guaranteed by design. Not subject to production testing.



DMG1013UW

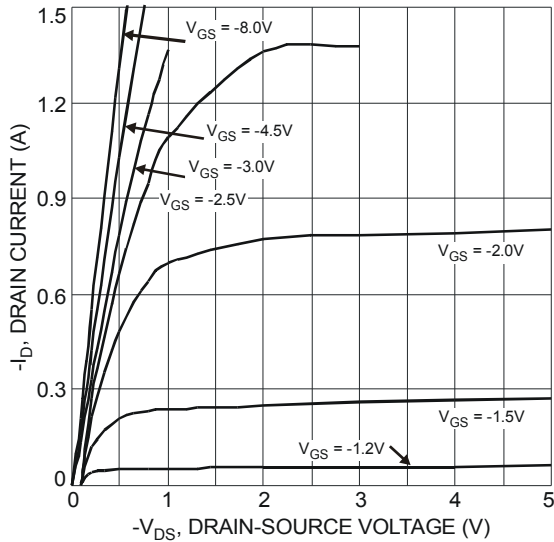

Fig. 1 Typical Output Characteristic

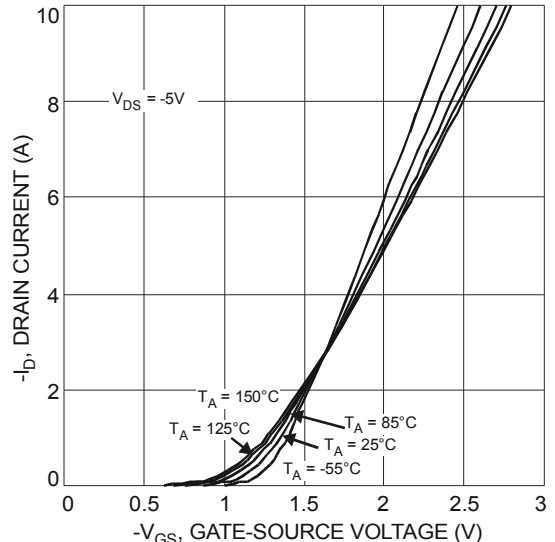

Fig. 2 Typical Transfer Characteristic

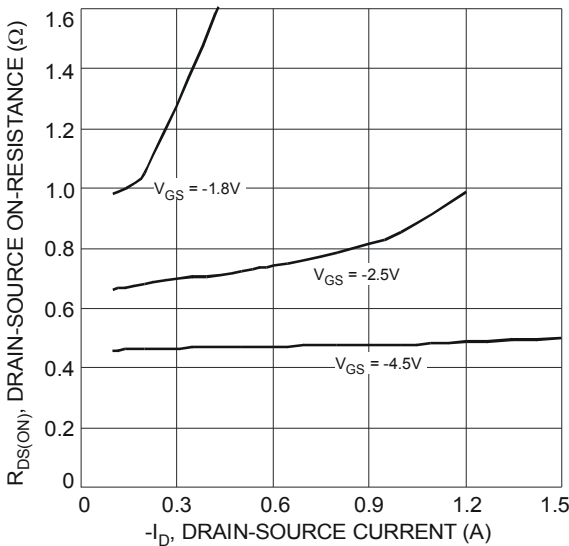

Fig. 3 Typical On-Resistance vs. Drain Current and Gate Voltage

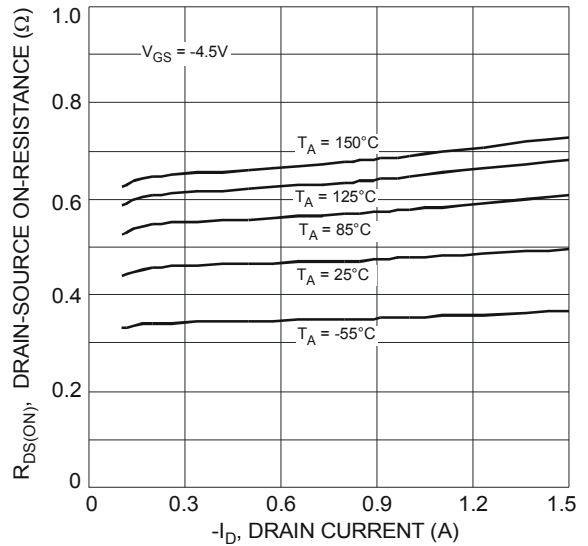

Fig. 4 Typical On-Resistance vs. Drain Current and Temperature

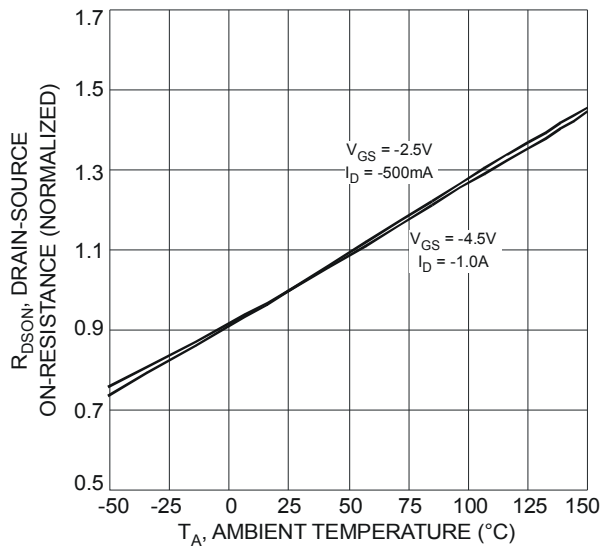

Fig. 5 On-Resistance Variation with Temperature

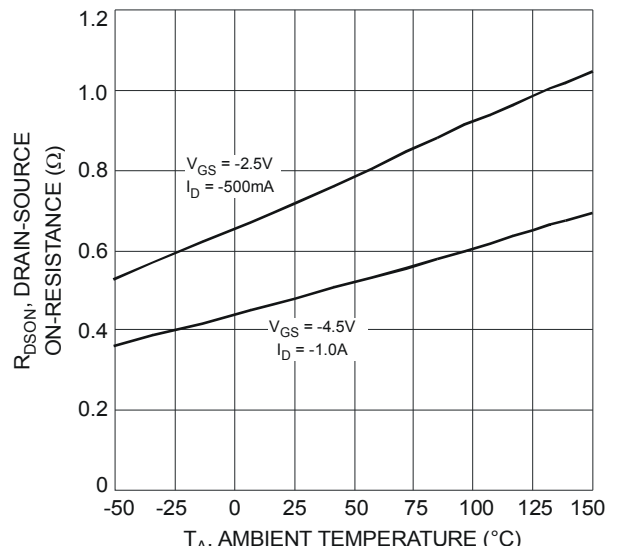

Fig. 6 On-Resistance Variation with Temperature



**DMG1013UW**

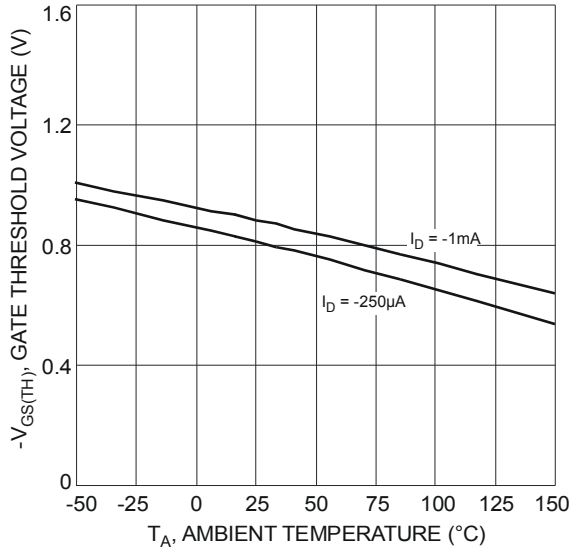

Fig. 7 Gate Threshold Variation vs. Ambient Temperature

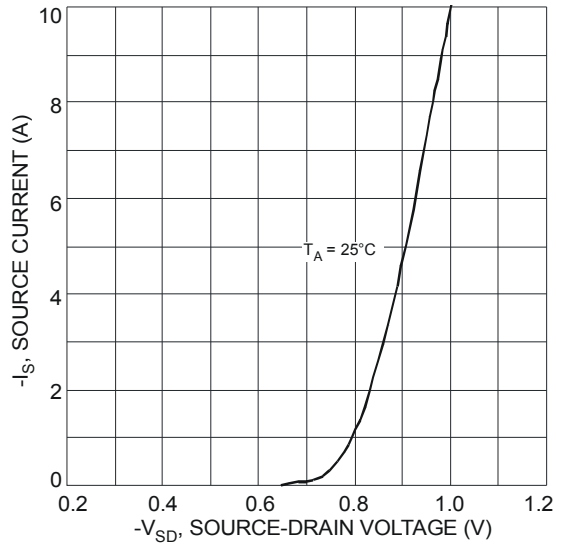

Fig. 8 Diode Forward Voltage vs. Current

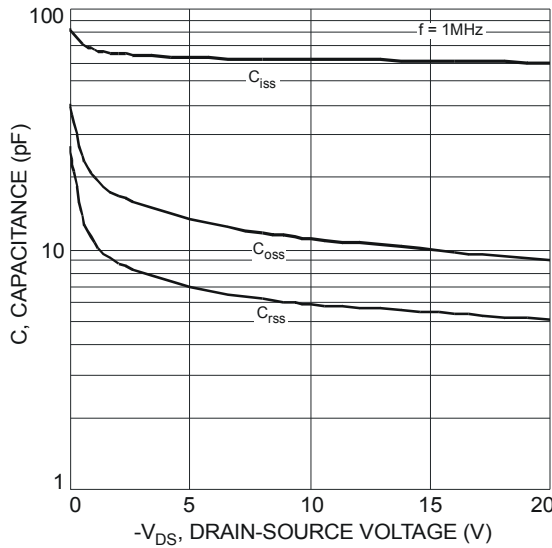

Fig. 9 Typical Total Capacitance

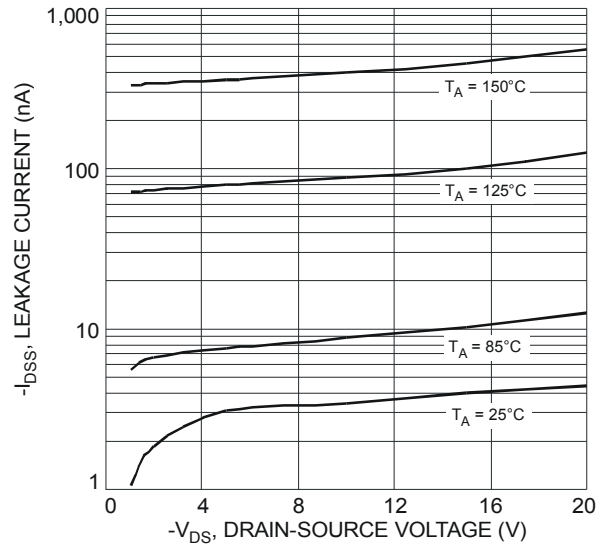

Fig. 10 Typical Leakage Current vs. Drain-Source Voltage

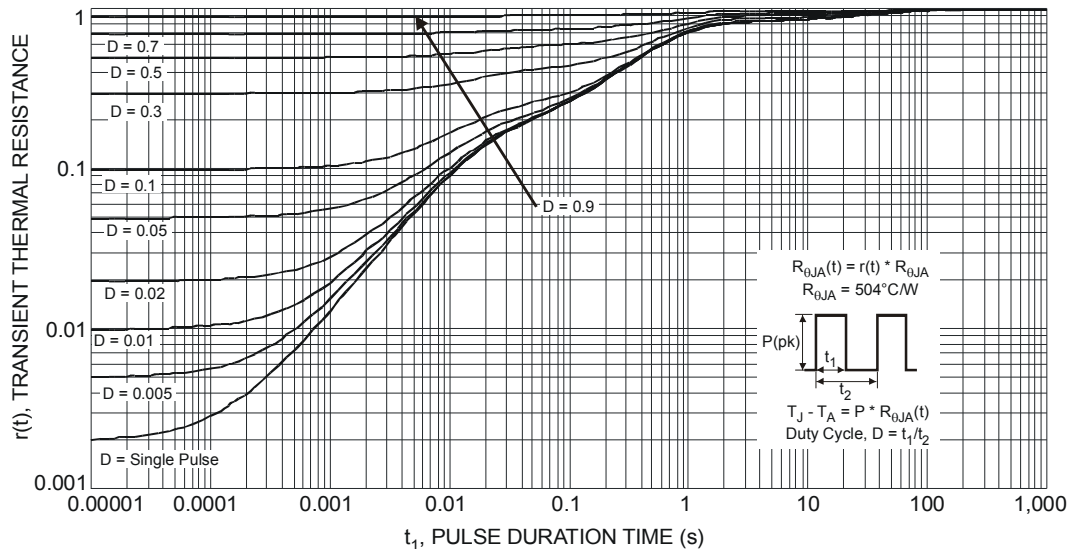
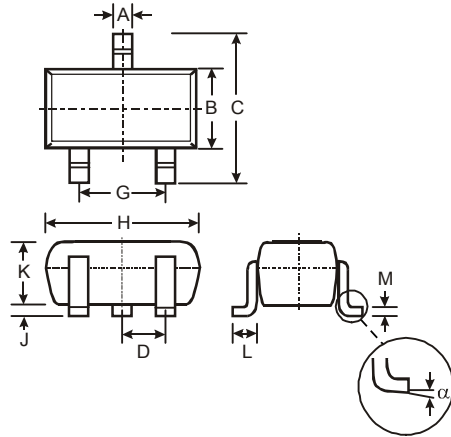

Fig. 11 Transient Thermal Response

## Package Outline Dimensions

Please see AP02002 at <http://www.diodes.com/datasheets/ap02002.pdf> for latest version.



SOT-323			
Dim	Min	Max	Typ
A	0.25	0.40	0.30
B	1.15	1.35	1.30
C	2.00	2.20	2.10
D	-	-	0.65
G	1.20	1.40	1.30
H	1.80	2.20	2.15
J	0.0	0.10	0.05
K	0.90	1.00	0.95
L	0.25	0.40	0.30
M	0.10	0.18	0.11
$\alpha$	0°	8°	-
All Dimensions in mm			

## Suggested Pad Layout

Please see AP02001 at <http://www.diodes.com/datasheets/ap02001.pdf> for the latest version.

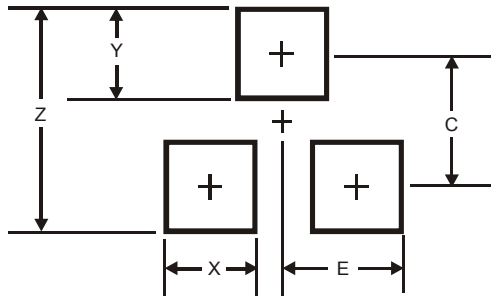

Dimensions	Value (in mm)
Z	2.8
X	0.7
Y	0.9
C	1.9
E	1.0



#### IMPORTANT NOTICE

DIODES INCORPORATED MAKES NO WARRANTY OF ANY KIND, EXPRESS OR IMPLIED, WITH REGARDS TO THIS DOCUMENT, INCLUDING, BUT NOT LIMITED TO, THE IMPLIED WARRANTIES OF MERCHANTABILITY AND FITNESS FOR A PARTICULAR PURPOSE (AND THEIR EQUIVALENTS UNDER THE LAWS OF ANY JURISDICTION).

Diodes Incorporated and its subsidiaries reserve the right to make modifications, enhancements, improvements, corrections or other changes without further notice to this document and any product described herein. Diodes Incorporated does not assume any liability arising out of the application or use of this document or any product described herein; neither does Diodes Incorporated convey any license under its patent or trademark rights, nor the rights of others. Any Customer or user of this document or products described herein in such applications shall assume all risks of such use and will agree to hold Diodes Incorporated and all the companies whose products are represented on Diodes Incorporated website, harmless against all damages.

Diodes Incorporated does not warrant or accept any liability whatsoever in respect of any products purchased through unauthorized sales channel. Should Customers purchase or use Diodes Incorporated products for any unintended or unauthorized application, Customers shall indemnify and hold Diodes Incorporated and its representatives harmless against all claims, damages, expenses, and attorney fees arising out of, directly or indirectly, any claim of personal injury or death associated with such unintended or unauthorized application.

Products described herein may be covered by one or more United States, international or foreign patents pending. Product names and markings noted herein may also be covered by one or more United States, international or foreign trademarks.

This document is written in English but may be translated into multiple languages for reference. Only the English version of this document is the final and determinative format released by Diodes Incorporated.

#### LIFE SUPPORT

Diodes Incorporated products are specifically not authorized for use as critical components in life support devices or systems without the express written approval of the Chief Executive Officer of Diodes Incorporated. As used herein:

A. Life support devices or systems are devices or systems which:

1. are intended to implant into the body, or
2. support or sustain life and whose failure to perform when properly used in accordance with instructions for use provided in the labeling can be reasonably expected to result in significant injury to the user.

B. A critical component is any component in a life support device or system whose failure to perform can be reasonably expected to cause the failure of the life support device or to affect its safety or effectiveness.

Customers represent that they have all necessary expertise in the safety and regulatory ramifications of their life support devices or systems, and acknowledge and agree that they are solely responsible for all legal, regulatory and safety-related requirements concerning their products and any use of Diodes Incorporated products in such safety-critical, life support devices or systems, notwithstanding any devices- or systems-related information or support that may be provided by Diodes Incorporated. Further, Customers must fully indemnify Diodes Incorporated and its representatives against any damages arising out of the use of Diodes Incorporated products in such safety-critical, life support devices or systems.

Copyright © 2013, Diodes Incorporated

[www.diodes.com](http://www.diodes.com)



## OUR CERTIFICATE

DiGi provide top-quality products and perfect service for customer worldwide through standardization, technological innovation and continuous improvement. DiGi through third-party certification, we stricly control the quality of products and services. Welcome your RFQ to

Email: [Info@DiGi-Electronics.com](mailto:Info@DiGi-Electronics.com)



Tel: +00 852-30501935

RFQ Email: [Info@DiGi-Electronics.com](mailto:Info@DiGi-Electronics.com)

DiGi is a global authorized distributor of electronic components.