

DMP6185SE-7 Datasheet

www.digi-electronics.com

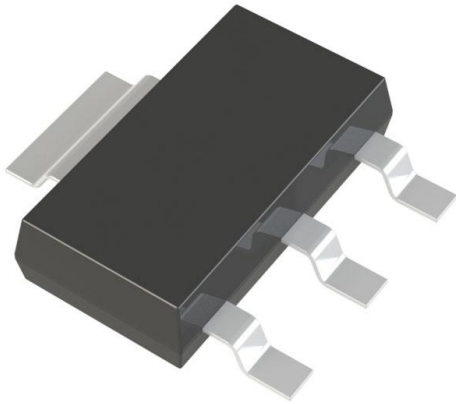

<https://www.DiGi-Electronics.com>

DiGi Electronics Part Number	DMP6185SE-7-DG
Manufacturer	Diodes Incorporated
Manufacturer Product Number	DMP6185SE-7
Description	MOSFET P-CH 60V 3A SOT223
Detailed Description	P-Channel 60 V 3A (Ta) 1.2W (Ta) Surface Mount SO T-223-3



Tel: +00 852-30501935

RFQ Email: Info@DiGi-Electronics.com

DiGi is a global authorized distributor of electronic components.

Purchase and inquiry

Manufacturer Product Number:

DMP6185SE-7

Series:

-

FET Type:

P-Channel

Drain to Source Voltage (Vdss):

60 V

Drive Voltage (Max Rds On, Min Rds On):

4.5V, 10V

Vgs(th) (Max) @ Id:

3V @ 250 μ A

Vgs (Max):

\pm 20V

FET Feature:

-

Operating Temperature:

-55°C ~ 150°C (Tj)

Qualification:

AEC-Q101

Supplier Device Package:

SOT-223-3

Base Product Number:

DMP6185

Manufacturer:

Diodes Incorporated

Product Status:

Discontinued at Digi-Key

Technology:

MOSFET (Metal Oxide)

Current - Continuous Drain (Id) @ 25°C:

3A (Ta)

Rds On (Max) @ Id, Vgs:

150mOhm @ 2.2A, 10V

Gate Charge (Qg) (Max) @ Vgs:

14 nC @ 10 V

Input Capacitance (Ciss) (Max) @ Vds:

708 pF @ 30 V

Power Dissipation (Max):

1.2W (Ta)

Grade:

Automotive

Mounting Type:

Surface Mount

Package / Case:

TO-261-4, TO-261AA

Environmental & Export classification

RoHS Status:

ROHS3 Compliant

REACH Status:

REACH Unaffected

HTSUS:

8541.29.0095

Moisture Sensitivity Level (MSL):

1 (Unlimited)

ECCN:

EAR99

**DMP6185SE****60V P-CHANNEL ENHANCEMENT MODE MOSFET**

Product Summary

BV _{DSS}	R _{DS(ON)}	I _D T _A = +25°C
-60V	150mΩ @ V _{GS} = -10V	-3A
	185mΩ @ V _{GS} = -4.5V	-2.7A

Description and Applications

This MOSFET has been designed to minimize the on-state resistance yet maintain superior switching performance, making it ideal for high efficiency power management applications.

- Motor Control
- Transformer Driving Switch
- DC-DC Converters
- Power Management Functions
- Uninterrupted Power Supply

Features and Benefits

- 100% Unclamped Inductive Switch (UIS) Test in Production
- Low On-Resistance
- Fast Switching Speed
- **Lead-Free Finish; RoHS Compliant (Notes 1 & 2)**
- **Halogen and Antimony Free. "Green" Device (Note 3)**
- **For automotive applications requiring specific change control (i.e. parts qualified to AEC-Q100/101/200, PPAP capable, and manufactured in IATF 16949 certified facilities), please [contact us](#) or your local Diodes representative. <https://www.diodes.com/quality/product-definitions/>**
- **An Automotive-Compliant Part is Available Under Separate Datasheet ([DMP6185SEQ](#))**

Mechanical Data

- Case: SOT223
- Case Material: Molded Plastic, "Green" Molding Compound. UL Flammability Classification Rating 94V-0
- Moisture Sensitivity: Level 1 per J-STD-020
- Terminals Connections: See Diagram Below
- Terminals: Finish - Matte Tin Annealed over Copper Lead Frame. Solderable per MIL-STD-202, Method 208
- Weight: 0.112 grams (Approximate)

SOT223



Top View

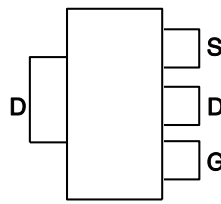

Pin Out - Top View

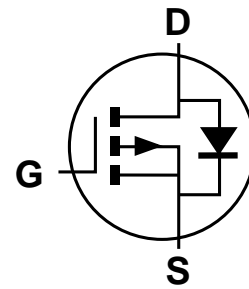

Equivalent Circuit

Ordering Information (Note 4)

Part Number	Case	Packaging
DMP6185SE-13	SOT223	2,500 / Tape & Reel

- Notes:
1. EU Directive 2002/95/EC (RoHS), 2011/65/EU (RoHS 2) & 2015/863/EU (RoHS 3) compliant. All applicable RoHS exemptions applied.
 2. See <https://www.diodes.com/quality/lead-free/> for more information about Diodes Incorporated's definitions of Halogen- and Antimony-free, "Green" and Lead-free.
 3. Halogen- and Antimony-free "Green" products are defined as those which contain <900ppm bromine, <900ppm chlorine (<1500ppm total Br + Cl) and <1000ppm antimony compounds.
 4. For packaging details, go to our website at <https://www.diodes.com/design/support/packaging/diodes-packaging/>.

Marking Information

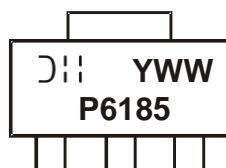

= Manufacturer's Marking
 P6185 = Marking Code
 YWW = Date Code Marking
 Y or Ȳ = Year (ex: 0 = 2020)
 WW = Week (01 to 53)



Maximum Ratings (@T_A = +25°C, unless otherwise specified.)

Characteristic	Symbol	Value	Unit
Drain-Source Voltage	V _{DSS}	-60	V
Gate-Source Voltage	V _{GS}	±20	V
Continuous Drain Current (Note 6) V _{GS} = -10V	I _D	T _A = +25°C	-3
		T _A = +70°C	-2.4
Maximum Body Diode Continuous Current	I _S	-2	A
Pulsed Drain Current (10μs Pulse, Duty Cycle = 1%)	I _{DM}	-15	A
Single Pulsed Avalanche Current (Note 7)	I _{AS}	-16	A
Single Pulsed Avalanche Energy (Note 7)	E _{AS}	13	mJ

Thermal Characteristics (@T_A = +25°C, unless otherwise specified.)

Characteristic	Symbol	Value	Unit
Total Power Dissipation (Note 5)	P _D	T _A = +25°C	1.2
		T _A = +70°C	0.8
Thermal Resistance, Junction to Ambient (Note 5)	R _{θJA}	Steady State	104
		t < 10s	51
Total Power Dissipation (Note 6)	P _D	T _A = +25°C	2.2
		T _A = +70°C	1.4
Thermal Resistance, Junction to Ambient (Note 6)	R _{θJA}	Steady State	60
		t < 10s	30
Thermal Resistance, Junction to Case (Note 6)	R _{θJC}	7.6	°C/W
Operating and Storage Temperature Range	T _J , T _{STG}	-55 to +150	°C

Electrical Characteristics (@T_A = +25°C, unless otherwise specified.)

Characteristic	Symbol	Min	Typ	Max	Unit	Test Condition
OFF CHARACTERISTICS (Note 8)						
Drain-Source Breakdown Voltage	BV _{DSS}	-60	—	—	V	V _{GS} = 0V, I _D = -250μA
Zero Gate Voltage Drain Current	I _{DSS}	—	—	-1	μA	V _{DS} = -48V, V _{GS} = 0V
Gate-Source Leakage	I _{GSS}	—	—	±100	nA	V _{GS} = ±20V, V _{DS} = 0V
ON CHARACTERISTICS (Note 8)						
Gate Threshold Voltage	V _{GS(TH)}	-1	—	-3	V	V _{DS} = V _{GS} , I _D = -250μA
Static Drain-Source On-Resistance	R _{DS(ON)}	—	110	150	mΩ	V _{GS} = -10V, I _D = -2.2A
			130	185		
Diode Forward Voltage	V _{SD}	—	-0.75	-0.95	V	V _{GS} = 0V, I _S = -1A
DYNAMIC CHARACTERISTICS (Note 9)						
Input Capacitance	C _{iss}	—	708	—	pF	V _{DS} = -30V, V _{GS} = 0V, f = 1MHz
Output Capacitance	C _{oss}	—	39	—	pF	
Reverse Transfer Capacitance	C _{rss}	—	32	—	pF	
Gate Resistance	R _g	—	17	28	Ω	V _{DS} = 0V, V _{GS} = 0V, f = 1MHz
Total Gate Charge (V _{GS} = -4.5V)	Q _g	—	6.2	—	nC	V _{DS} = -30V, I _D = -12A
Total Gate Charge (V _{GS} = -10V)	Q _g	—	14	—	nC	
Gate-Source Charge	Q _{gs}	—	2.8	—	nC	
Gate-Drain Charge	Q _{gd}	—	3.1	—	nC	
Turn-On Delay Time	t _{D(ON)}	—	5.2	—	ns	V _{DS} = -30V, R _L = 2.5Ω V _{GS} = -10V, R _G = 3Ω
Turn-On Rise Time	t _r	—	23	—	ns	
Turn-Off Delay Time	t _{D(OFF)}	—	33	—	ns	
Turn-Off Fall Time	t _f	—	39	—	ns	
Body Diode Reverse Recovery Time	t _{RR}	—	22	—	ns	I _F = -12A, di/dt = 100A/μs
Body Diode Reverse Recovery Charge	Q _{RR}	—	17	—	nC	

- Notes:
- Device mounted on FR-4 substrate PC board, 2oz copper, with minimum recommended pad layout.
 - Device mounted on FR-4 substrate PC board, 2oz copper, with 1inch square copper plate.
 - UIS in production with L = 0.1mH, starting T_A = +25°C.
 - Short duration pulse test used to minimize self-heating effect.
 - Guaranteed by design. Not subject to product testing.



DMP6185SE

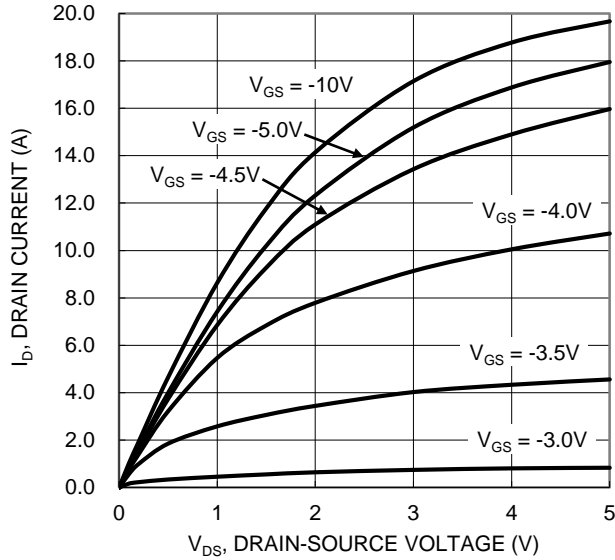

Figure 1. Typical Output Characteristic

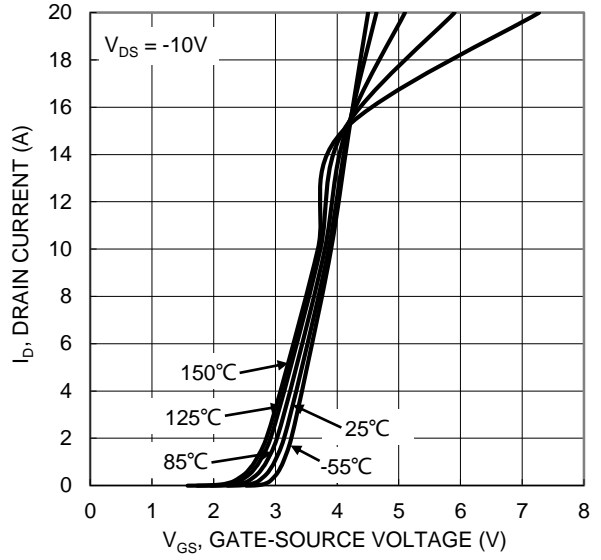

Figure 2. Typical Transfer Characteristic

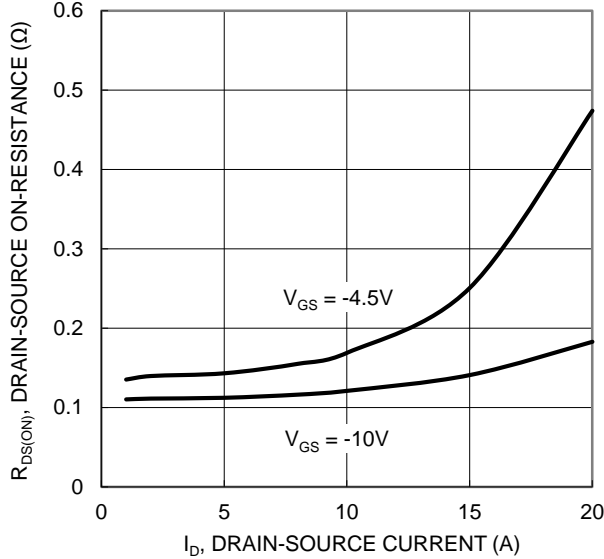

Figure 3. Typical On-Resistance vs. Drain Current and Gate Voltage

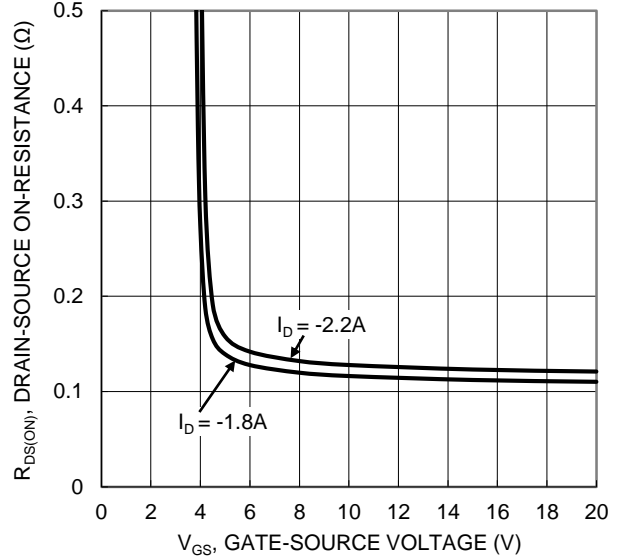

Figure 4. Typical Transfer Characteristic

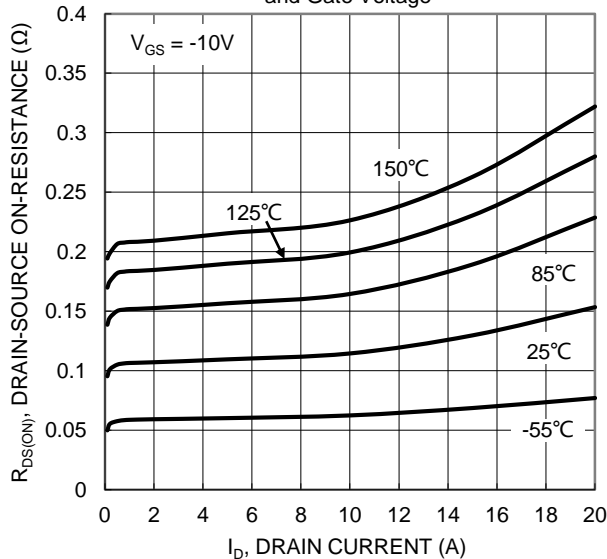

Figure 5. Typical On-Resistance vs. Drain Current and Temperature

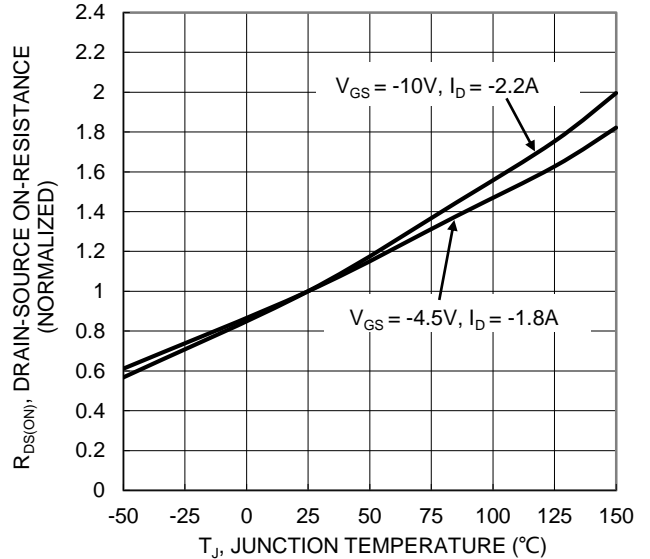

Figure 6. On-Resistance Variation with Temperature



DMP6185SE

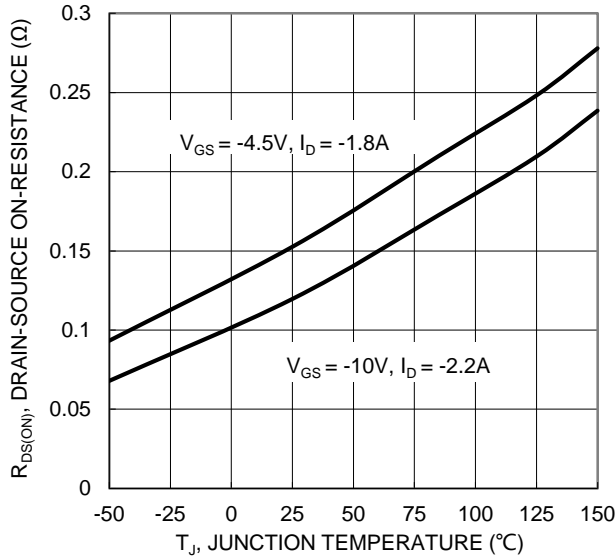

Figure 7. On-Resistance Variation with Temperature

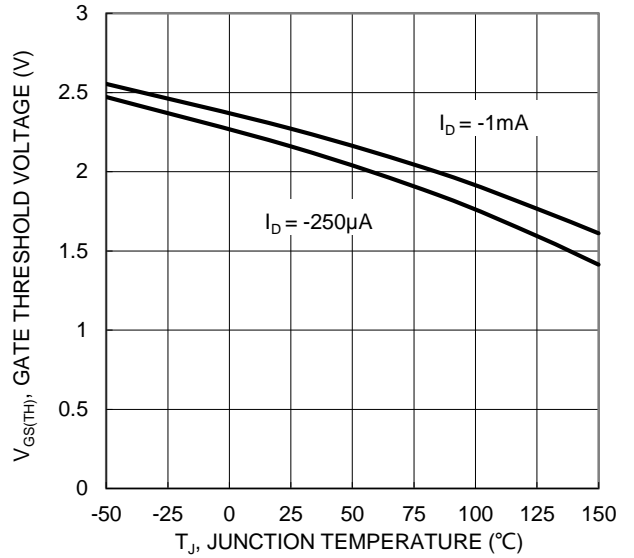

Figure 8. Gate Threshold Variation vs. Junction Temperature

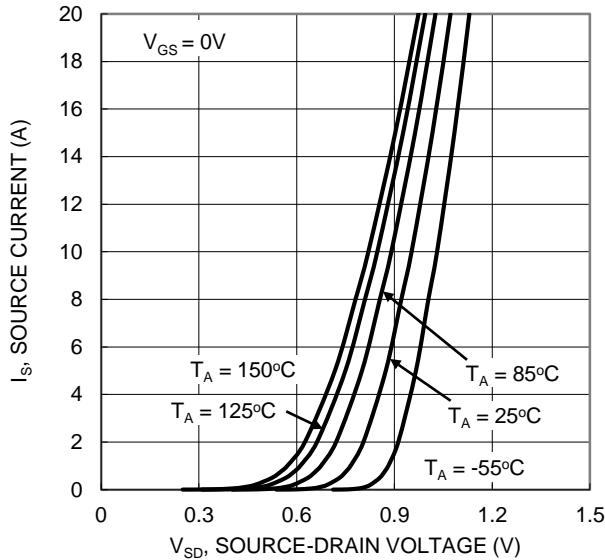

Figure 9. Diode Forward Voltage vs. Current

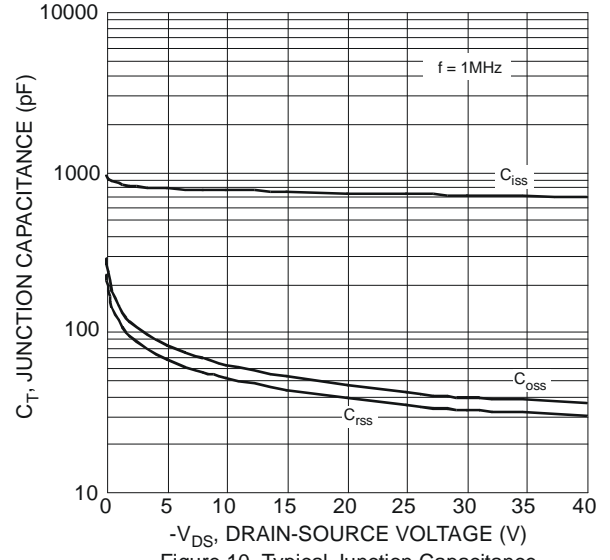

Figure 10. Typical Junction Capacitance

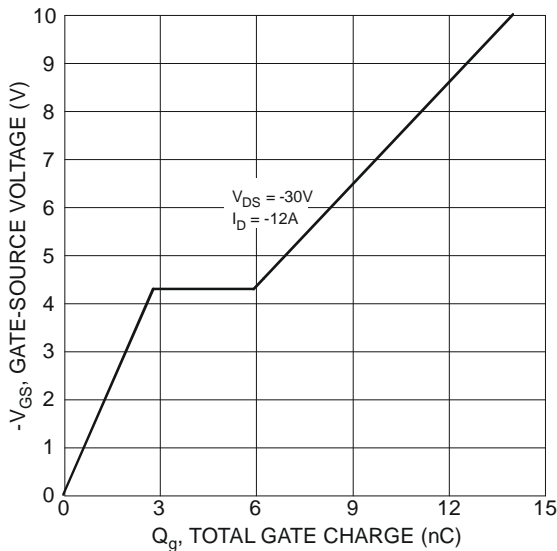

Figure 11. Gate-Charge Characteristics

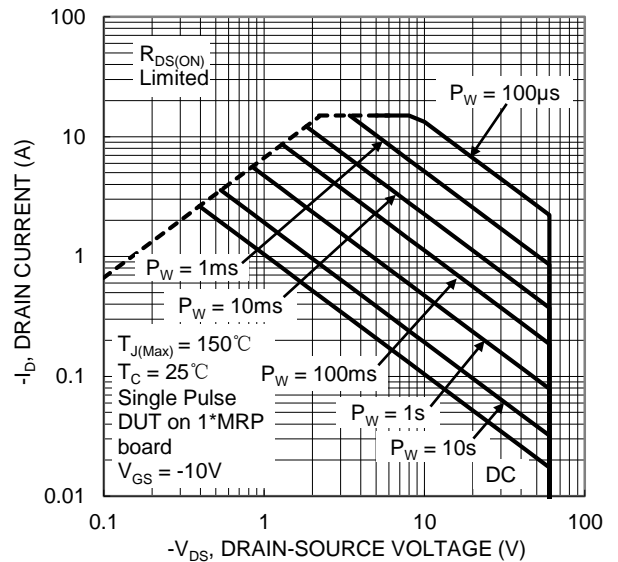

Figure 12. SOA, Safe Operation Area



DMP6185SE

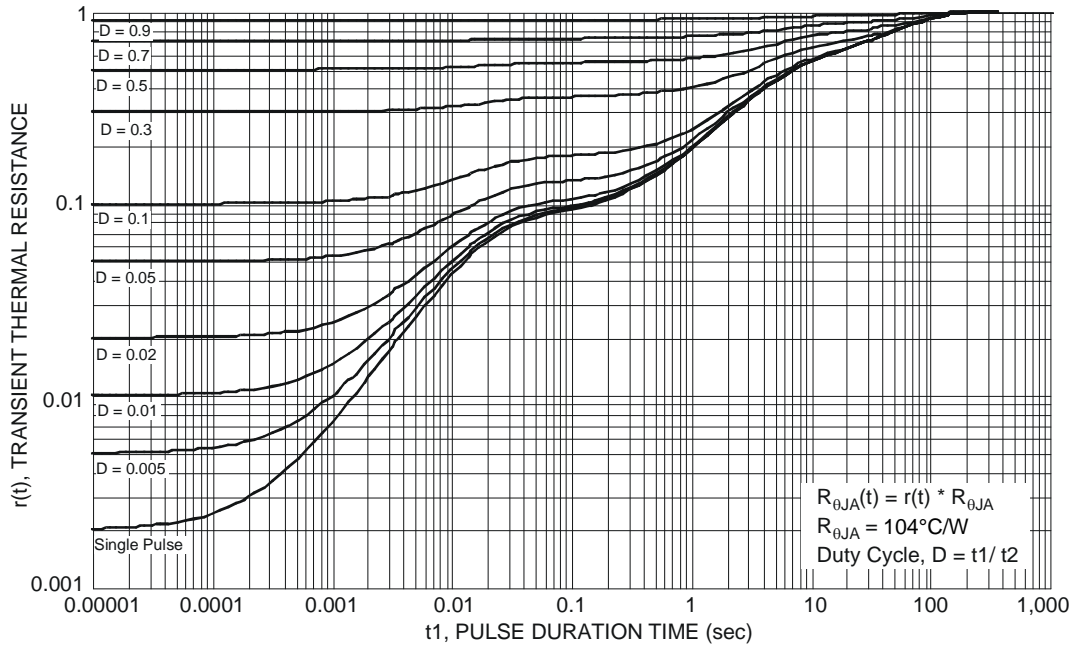
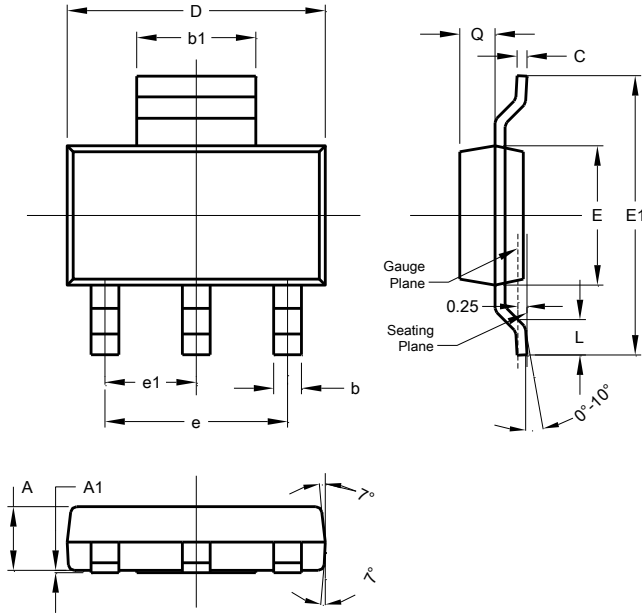

Figure 13 Transient Thermal Resistance

Package Outline Dimensions

Please see <http://www.diodes.com/package-outlines.html> for the latest version.

SOT223



SOT223			
Dim	Min	Max	Typ
A	1.55	1.65	1.60
A1	0.010	0.15	0.05
b	0.60	0.80	0.70
b1	2.90	3.10	3.00
C	0.20	0.30	0.25
D	6.45	6.55	6.50
E	3.45	3.55	3.50
E1	6.90	7.10	7.00
e	-	-	4.60
e1	-	-	2.30
L	0.85	1.05	0.95
Q	0.84	0.94	0.89
All Dimensions in mm			

Suggested Pad Layout

Please see <http://www.diodes.com/package-outlines.html> for the latest version.

SOT223

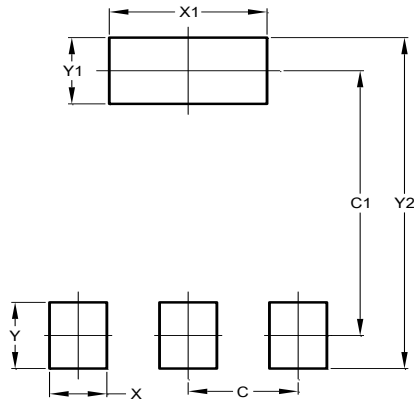

Dimensions	Value (in mm)
C	2.30
C1	6.40
X	1.20
X1	3.30
Y	1.60
Y1	1.60
Y2	8.00

**IMPORTANT NOTICE**

DIODES INCORPORATED MAKES NO WARRANTY OF ANY KIND, EXPRESS OR IMPLIED, WITH REGARDS TO THIS DOCUMENT, INCLUDING, BUT NOT LIMITED TO, THE IMPLIED WARRANTIES OF MERCHANTABILITY AND FITNESS FOR A PARTICULAR PURPOSE (AND THEIR EQUIVALENTS UNDER THE LAWS OF ANY JURISDICTION).

Diodes Incorporated and its subsidiaries reserve the right to make modifications, enhancements, improvements, corrections or other changes without further notice to this document and any product described herein. Diodes Incorporated does not assume any liability arising out of the application or use of this document or any product described herein; neither does Diodes Incorporated convey any license under its patent or trademark rights, nor the rights of others. Any Customer or user of this document or products described herein in such applications shall assume all risks of such use and will agree to hold Diodes Incorporated and all the companies whose products are represented on Diodes Incorporated website, harmless against all damages.

Diodes Incorporated does not warrant or accept any liability whatsoever in respect of any products purchased through unauthorized sales channel. Should Customers purchase or use Diodes Incorporated products for any unintended or unauthorized application, Customers shall indemnify and hold Diodes Incorporated and its representatives harmless against all claims, damages, expenses, and attorney fees arising out of, directly or indirectly, any claim of personal injury or death associated with such unintended or unauthorized application.

Products described herein may be covered by one or more United States, international or foreign patents pending. Product names and markings noted herein may also be covered by one or more United States, international or foreign trademarks.

This document is written in English but may be translated into multiple languages for reference. Only the English version of this document is the final and determinative format released by Diodes Incorporated.

LIFE SUPPORT

Diodes Incorporated products are specifically not authorized for use as critical components in life support devices or systems without the express written approval of the Chief Executive Officer of Diodes Incorporated. As used herein:

A. Life support devices or systems are devices or systems which:

1. are intended to implant into the body, or
2. support or sustain life and whose failure to perform when properly used in accordance with instructions for use provided in the labeling can be reasonably expected to result in significant injury to the user.

B. A critical component is any component in a life support device or system whose failure to perform can be reasonably expected to cause the failure of the life support device or to affect its safety or effectiveness.

Customers represent that they have all necessary expertise in the safety and regulatory ramifications of their life support devices or systems, and acknowledge and agree that they are solely responsible for all legal, regulatory and safety-related requirements concerning their products and any use of Diodes Incorporated products in such safety-critical, life support devices or systems, notwithstanding any devices- or systems-related information or support that may be provided by Diodes Incorporated. Further, Customers must fully indemnify Diodes Incorporated and its representatives against any damages arising out of the use of Diodes Incorporated products in such safety-critical, life support devices or systems.

Copyright © 2020, Diodes Incorporated

www.diodes.com

OUR CERTIFICATE

DiGi provide top-quality products and perfect service for customer worldwide through standardization, technological innovation and continuous improvement. DiGi through third-party certification, we stricly control the quality of products and services. Welcome your RFQ to

Email: Info@DiGi-Electronics.com



Tel: +00 852-30501935

RFQ Email: Info@DiGi-Electronics.com

DiGi is a global authorized distributor of electronic components.