

FN0100007 Datasheet

www.digi-electronics.com



<https://www.DiGi-Electronics.com>

DiGi Electronics Part Number	FN0100007-DG
Manufacturer	Diodes Incorporated
Manufacturer Product Number	FN0100007
Description	XTAL OSC XO 1.0000MHZ CMOS SMD
Detailed Description	1 MHz XO (Standard) CMOS Oscillator 3.3V Enable/ Disable 4-SMD, No Lead



Tel: +00 852-30501935

RFQ Email: Info@DiGi-Electronics.com

DiGi is a global authorized distributor of electronic components.

Purchase and inquiry

Manufacturer Product Number:

FN0100007

Series:

SaRonix-eCera™ FN

Base Resonator:

Crystal

Frequency:

1 MHz

Output:

CMOS

Frequency Stability:

±50ppm

Operating Temperature:

-40°C ~ 85°C

Ratings:

-

Package / Case:

4-SMD, No Lead

Height - Seated (Max):

0.071" (1.80mm)

Manufacturer:

Diodes Incorporated

Product Status:

Active

Type:

XO (Standard)

Function:

Enable/Disable

Voltage - Supply:

3.3V

Absolute Pull Range (APR):

-

Current - Supply (Max):

15mA

Mounting Type:

Surface Mount

Size / Dimension:

0.276" L x 0.197" W (7.00mm x 5.00mm)

Current - Supply (Disable) (Max):

10µA

Environmental & Export classification

RoHS Status:

ROHS3 Compliant

REACH Status:

REACH Unaffected

HTSUS:

8542.39.0001

Moisture Sensitivity Level (MSL):

1 (Unlimited)

ECCN:

EAR99

3.3V CMOS Low Jitter XO

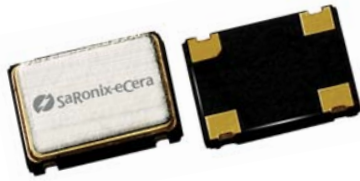

7.0 x 5.0mm Ceramic SMD

Product Features

- 1 to 166 MHz Frequency Range
- <1 ps RMS jitter
- 3.3V CMOS/TTL compatible logic levels
- Pin-compatible with standard 7.0 x 5.0mm packages
- Designed for standard reflow and washing techniques
- Low power standby mode
- Pb-free and RoHS/Green compliant

Product Description

The FN Series 3.3V crystal clock oscillator achieves superb jitter and stability over a broad range of operating conditions and frequencies. The output clock signal, generated internally with a non-PLL oscillator design, is compatible with LVCMOS/LVTTL logic levels. The device, available on tape and reel, is contained in a 7.0 x 5.0mm surface-mount ceramic package.

Applications

Ideal for low jitter or tight stability applications:

- Ethernet
- 802.11a/b/g WiFi
- Fibre Channel
- EPON
- SONET/SDH linecards
- DSLAM
- T1/E1, T3/E3 linecards
- Serial Attached SCSI (SAS)
- Server & Storage platforms

Package:

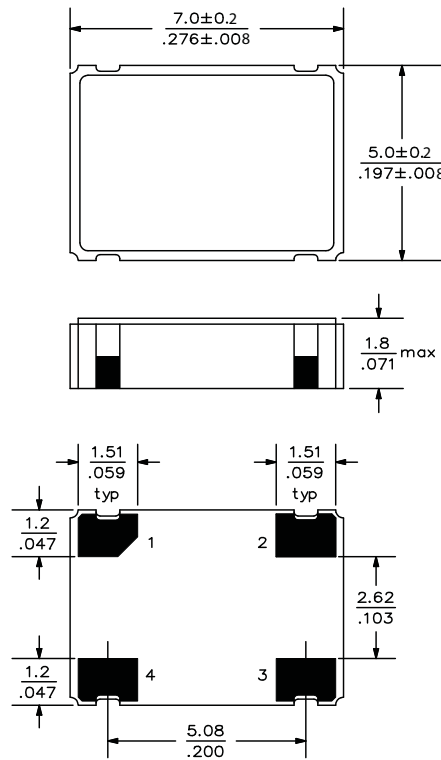

Recommended Land Pattern:

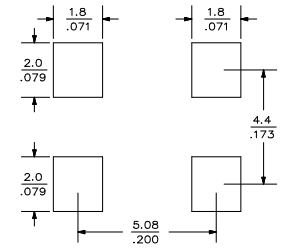

Pin Functions:

Pin	Function
1	OE Function
2	Ground
3	Clock Output
4	V _{DD}

Part Ordering Information:

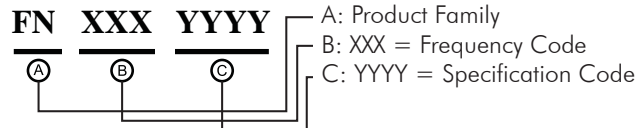

Following the above format, Saronix-eCera part numbers will be assigned upon confirmation of exact customer requirements.

Legacy Ordering Information - For Reference Only:

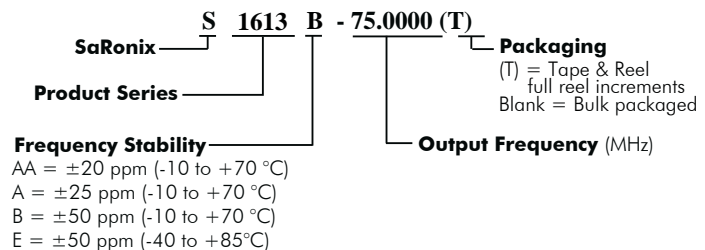

3.3V CMOS Low Jitter XO **FN**
FN Series Crystal Clock Oscillator (XO)
 Legacy S1613 Series | 7.0 x 5.0mm

Electrical Performance

Parameter	Min.	Typ.	Max.	Units	Notes
Output Frequency	1		166	MHz	As specified
Supply Voltage	+2.97	+3.3	+3.63	V	
Supply Current, Output Enabled			15	mA	1 to 32 MHz
			25		32 to 50 MHz
			40		50 to 80 MHz
			55		80 to 166 MHz
Supply Current, Standby Mode			10	μA	1 to 36 MHz, 100 to 166 MHz
			100	μA	36 to 70 MHz
Frequency Stability			±20 to ±50	ppm	See Note 1 below
Operating Temperature Range	-20		+70	°C	Commercial (standard)
	-40		+85		Industrial (standard)
Output Logic 0, V _{OL}			10% V _{DD}	V	
Output Logic 1, V _{OH}	90% V _{DD}			V	
Output Load			15	pF	
Duty Cycle	45		55	%	Measured 50% V _{DD}
Rise and Fall Time	up to 50 MHz		7	ns	Measured 20/80% of waveform
	50 to 80 MHz		5		
	80 to 124 MHz		3		
	125 to 166 MHz		2.5		
Jitter, Phase	1 to 166 MHz		1	ps RMS (1-σ)	10kHz to 20 MHz frequency band
Jitter, Accumulated	up to 80 MHz		5	ps RMS (1-σ)	20.000 adjacent periods
	80 to 166 MHz		3		
Jitter, Total	up to 80 MHz		50	ps pk-pk	100.000 random periods
	80 to 166 MHz		30		

Notes:

- Stability includes all combinations of operating temperature, load changes, rated input (supply) voltage changes, initial calibration tolerance (25°C), aging (1 year at 25°C average effective ambient temperature), shock and vibration.
- For specifications other than those listed, please contact sales.

Output Enable / Disable Function

Parameter	Min.	Typ.	Max.	Units	Notes
Input Voltage (pin 1), Output Enable	2.0			V	or open
Input Voltage (pin 1), Output Disable (low power standby)			0.5	V	Output is Hi-Z
Internal Pullup Resistance	50			kΩ	
Output Disable Delay			100	ns	
Output Enable Delay			10	ms	

Absolute Maximum Ratings

Parameter	Min.	Typ.	Max.	Units	Notes
Storage Temperature	-55		+125	°C	

3.3V CMOS Low Jitter XO FN



FN Series Crystal Clock Oscillator (XO)
Legacy S1613 Series | 7.0 x 5.0mm

Test Circuit

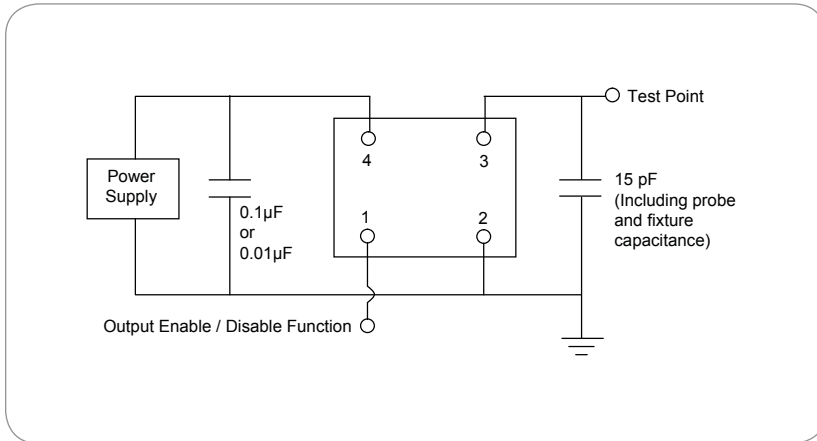

Reflow Soldering Profile

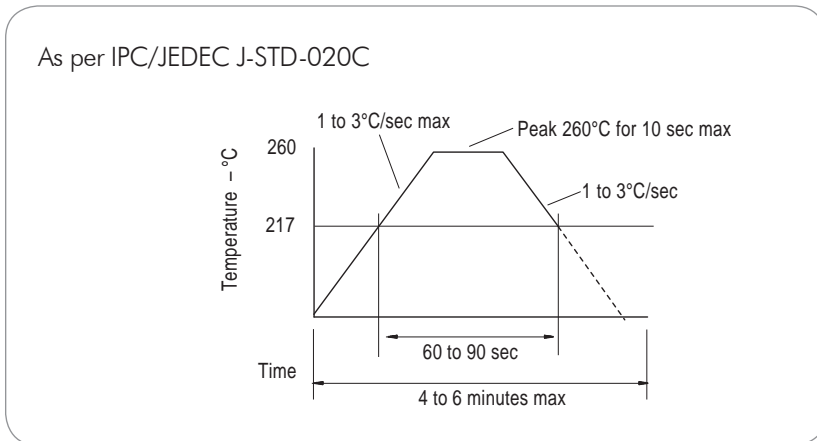

Reliability Test Ratings

This product is rated to meet the following test conditions:

Type	Parameter	Test Condition
Mechanical	Shock	MIL-STD-883, Method 2002, Condition B
Mechanical	Solderability	JESD22-B102-D Method 2 (Preconditioning E)
Mechanical	Terminal strength	MIL-STD-883, Method 2004, Condition D
Mechanical	Gross leak	MIL-STD-883, Method 1014, Condition C
Mechanical	Fine leak	MIL-STD-883, Method 1014, Condition A2 ($R_1 = 2 \times 10^{-8}$ atm cc/s)
Mechanical	Solvent resistance	MIL-STD-202, Method 215
Environmental	Thermal shock	MIL-STD-883, Method 1011, Condition A
Environmental	Moisture resistance	MIL-STD-883, Method 1004
Environmental	Vibration	MIL-STD-883, Method 2007, Condition A
Environmental	Resistance to soldering heat	J-STD-020C Table 5-2 Pb-free devices (2 cycles max)

OUR CERTIFICATE

DiGi provide top-quality products and perfect service for customer worldwide through standardization, technological innovation and continuous improvement. DiGi through third-party certification, we stricly control the quality of products and services. Welcome your RFQ to

Email: Info@DiGi-Electronics.com



Tel: +00 852-30501935

RFQ Email: Info@DiGi-Electronics.com

DiGi is a global authorized distributor of electronic components.