

MMBT4401-7 Datasheet



<https://www.DiGi-Electronics.com>

DiGi Electronics Part Number	MMBT4401-7-DG
Manufacturer	Diodes Incorporated
Manufacturer Product Number	MMBT4401-7
Description	TRANS NPN 40V 0.6A SOT23-3
Detailed Description	Bipolar (BJT) Transistor NPN 40 V 600 mA 250MHz 300 mW Surface Mount SOT-23-3



Tel: +00 852-30501935

RFQ Email: Info@DiGi-Electronics.com

DiGi is a global authorized distributor of electronic components.

Purchase and inquiry

Manufacturer Product Number:

MMBT4401-7

Series:

-

Transistor Type:

NPN

Voltage - Collector Emitter Breakdown (Max):

40 V

Current - Collector Cutoff (Max):

100nA

Power - Max:

300 mW

Operating Temperature:

-55°C ~ 150°C (TJ)

Qualification:

AEC-Q101

Package / Case:

TO-236-3, SC-59, SOT-23-3

Base Product Number:

MMBT4401

Manufacturer:

Diodes Incorporated

Product Status:

Discontinued at Digi-Key

Current - Collector (Ic) (Max):

600 mA

Vce Saturation (Max) @ Ib, Ic:

750mV @ 50mA, 500mA

DC Current Gain (hFE) (Min) @ Ic, Vce:

100 @ 150mA, 1V

Frequency - Transition:

250MHz

Grade:

Automotive

Mounting Type:

Surface Mount

Supplier Device Package:

SOT-23-3

Environmental & Export classification

RoHS Status:

RoHS non-compliant

REACH Status:

REACH Unaffected

HTSUS:

8541.21.0075

Moisture Sensitivity Level (MSL):

1 (Unlimited)

ECCN:

EAR99

Features

- Epitaxial Planar Die Construction
- Ideal for Medium Power Amplification and Switching
- Complementary PNP Type: MMBT4403
- **Totally Lead-Free & Fully RoHS Compliant (Notes 1 & 2)**
- **Halogen and Antimony Free. "Green" Device (Note 3)**
- **An automotive-compliant part is available under separate datasheet ([MMBT4401Q](#))**

Mechanical Data

- Package: SOT23
- Package Material: Molded Plastic "Green" Compound
UL Flammability Rating 94V-0
- Moisture Sensitivity: Level 1 per J-STD-020
- Terminals: Finish - Matte Tin Plated Leads, Solderable per MIL-STD-202, Method 208 ③
- Weight: 0.008 grams (Approximate)

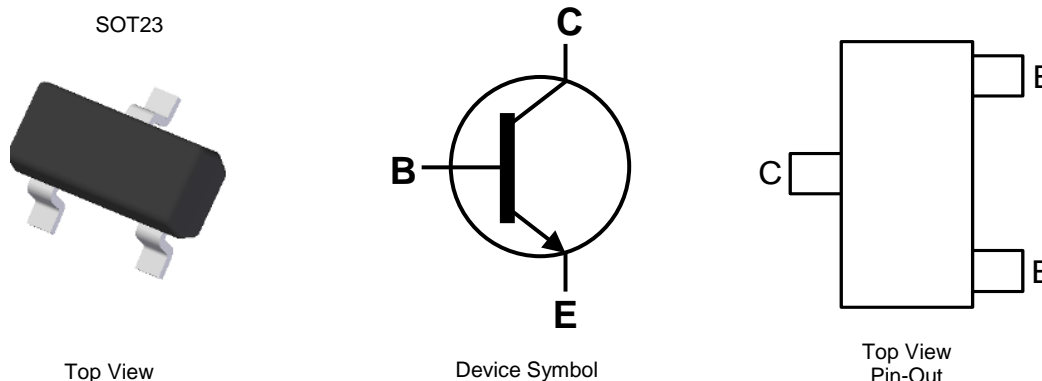

Ordering Information (Note 4)

Part Number	Package	Marking	Reel Size (inches)	Tape Width (mm)	Packing	
					Qty.	Carrier
MMBT4401-7-F	SOT23	K2X	7	8	3,000	Reel
MMBT4401-13-F	SOT23	K2X	13	8	10,000	Reel

- Notes:
1. No purposely added lead. Fully EU Directive 2002/95/EC (RoHS), 2011/65/EU (RoHS 2) & 2015/863/EU (RoHS 3) compliant.
 2. See <https://www.diodes.com/quality/lead-free/> for more information about Diodes Incorporated's definitions of Halogen- and Antimony-free, "Green" and Lead-free.
 3. Halogen- and Antimony-free "Green" products are defined as those which contain <900ppm bromine, <900ppm chlorine (<1500ppm total Br + Cl) and <1000ppm antimony compounds.
 4. For packaging details, go to our website at <https://www.diodes.com/design/support/packaging/diodes-packaging/>.

Marking Information

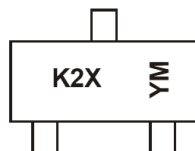

K2X = Product Type Marking Code
 YM = Date Code Marking
 Y or \bar{Y} = Year (ex: K = 2023)
 M or \bar{M} = Month (ex: 9 = September)

Date Code Key

Year	2010	-	2023	2024	2025	2026	2027	2028	2029	2030	2031	2032
Code	X	-	K	L	M	N	P	R	S	T	U	V

Month	Jan	Feb	Mar	Apr	May	Jun	Jul	Aug	Sep	Oct	Nov	Dec
Code	1	2	3	4	5	6	7	8	9	O	N	D



MMBT4401

Absolute Maximum Ratings (@ T_A = +25°C, unless otherwise specified.)

Characteristic	Symbol	Value	Unit
Collector-Base Voltage	V _{CBO}	60	V
Collector-Emitter Voltage	V _{CEO}	40	V
Emitter-Base Voltage	V _{EBO}	6.0	V
Collector Current	I _C	600	mA
Peak Collector Current	I _{CM}	1	A
Peak Base Current	I _{BM}	200	mA

Thermal Characteristics (@ T_A = +25°C, unless otherwise specified.)

Characteristic	Symbol	Value	Unit
Power Dissipation	P _D	(Note 5)	310
		(Note 6)	350
Thermal Resistance, Junction to Ambient	R _{θJA}	(Note 5)	403
		(Note 6)	357
Thermal Resistance, Junction to Leads	R _{θJL}	350	°C/W
Thermal Resistance, Junction to Case	R _{θJC}	120	°C/W
Operating and Storage Temperature Range	T _J , T _{STG}	-55 to +150	°C

ESD Ratings (Note 8)

Characteristic	Symbol	Value	Unit	JEDEC Class
Electrostatic Discharge - Human Body Model	ESD HBM	4,000	V	3A
Electrostatic Discharge - Machine Model	ESD MM	400	V	C
Electrostatic Discharge - Charged Device Model	ESD CDM	1,000	V	C3

- Notes:
5. For a device mounted on minimum recommended pad layout 1oz copper that is on a single-sided FR4 PCB; device is measured under still air conditions whilst operating in a steady-state.
 6. Same as note (5), except the device is mounted on 15mm x 15mm 1oz copper.
 7. Thermal resistance from junction to solder-point (at the end of the leads).
 8. Refer to JEDEC specification JESD22-A114, JESD22-A115 and JES-022-C101.



Thermal Characteristics and Derating Information

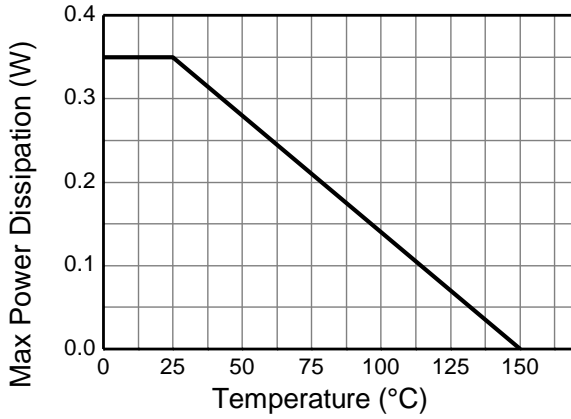

Figure 1. Derating Curve

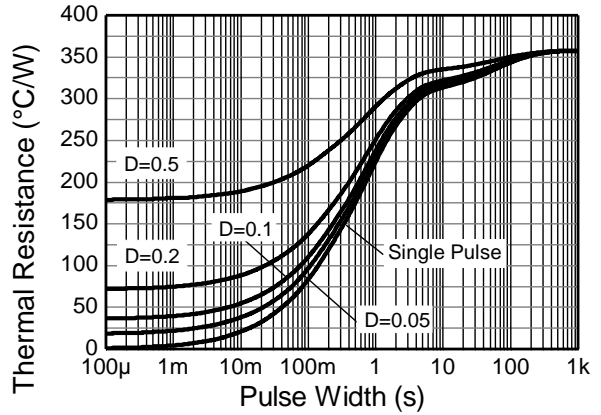

Figure 2. Transient Thermal Impedance

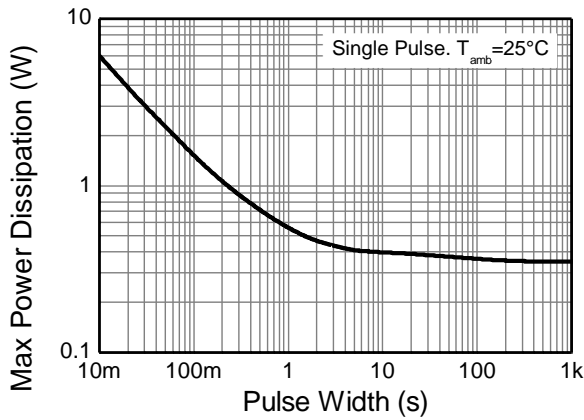

Figure 3. Pulse Power Dissipation

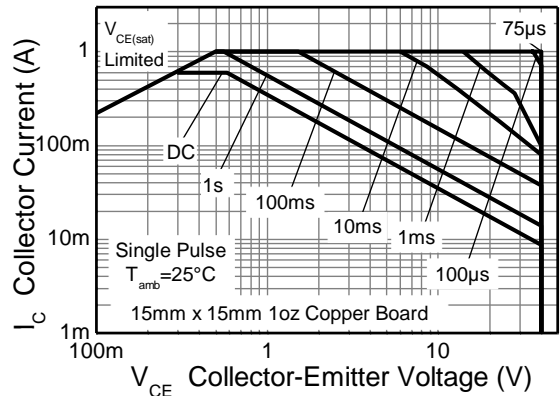

Figure 4. Safe Operating Area



MMBT4401

Electrical Characteristics (@ $T_A = +25^\circ\text{C}$, unless otherwise specified.)

Characteristic	Symbol	Min	Max	Unit	Test Condition	
OFF CHARACTERISTICS						
Collector-Base Breakdown Voltage	BV_{CBO}	60	—	V	$I_C = 100\mu\text{A}$	
Collector-Emitter Breakdown Voltage (Note 9)	BV_{CEO}	40	—	V	$I_C = 10\text{mA}$	
Emitter-Base Breakdown Voltage	BV_{EBO}	6	—	V	$I_E = 100\mu\text{A}$	
Collector Cutoff Current	I_{CEX}	—	100	nA	$V_{CE} = 35\text{V}$, $V_{EB(off)} = 0.4\text{V}$	
Base Cutoff Current	I_{BL}	—	100	nA	$V_{CE} = 35\text{V}$, $V_{EB(off)} = 0.4\text{V}$	
ON CHARACTERISTICS (Note 9)						
DC Current Gain	h_{FE}	20	—	—	$I_C = 100\mu\text{A}$, $V_{CE} = 1\text{V}$	
		40	—			$I_C = 1\text{mA}$, $V_{CE} = 1\text{V}$
		80	—			$I_C = 10\text{mA}$, $V_{CE} = 1\text{V}$
		100	300			$I_C = 150\text{mA}$, $V_{CE} = 1\text{V}$
		40	—			$I_C = 500\text{mA}$, $V_{CE} = 2\text{V}$
Collector-Emitter Saturation Voltage	$V_{CE(sat)}$	—	0.4 0.75	V	$I_C = 150\text{mA}$, $I_B = 15\text{mA}$ $I_C = 500\text{mA}$, $I_B = 50\text{mA}$	
Base-Emitter Saturation Voltage	$V_{BE(sat)}$	0.75 —	0.95 1.2	V	$I_C = 150\text{mA}$, $I_B = 15\text{mA}$ $I_C = 500\text{mA}$, $I_B = 50\text{mA}$	
SMALL SIGNAL CHARACTERISTICS						
Output Capacitance	C_{cb}	—	6.5	pF	$V_{CB} = 5\text{V}$, $f = 1\text{MHz}$	
Input Capacitance	C_{eb}	—	30	pF	$V_{EB} = 0.5\text{V}$, $f = 1\text{MHz}$	
Input Impedance	h_{ie}	1	15	k Ω	$V_{CE} = 10\text{V}$, $I_C = 1\text{mA}$, $f = 1\text{kHz}$	
Voltage Feedback Ratio	h_{re}	0.1	8	$\times 10^{-4}$		
Small Signal Current Gain	h_{fe}	40	500	—		
Output Admittance	h_{oe}	1	30	μS		
Current Gain-Bandwidth Product	f_T	250	—	MHz		$V_{CE} = 10\text{V}$, $I_C = 20\text{mA}$, $f = 100\text{MHz}$
SWITCHING CHARACTERISTICS						
Delay Time	t_d	—	15	ns	$V_{CC} = 30\text{V}$, $I_C = 150\text{mA}$, $V_{BE(off)} = 2\text{V}$, $I_{B1} = 15\text{mA}$	
Rise Time	t_r	—	20	ns		
Storage Time	t_s	—	225	ns	$V_{CC} = 30\text{V}$, $I_C = 150\text{mA}$, $I_{B1} = -I_{B2} = 15\text{mA}$	
Fall Time	t_f	—	30	ns		

Note: 9. Measured under pulsed conditions. Pulse width $\leq 300\mu\text{s}$. Duty cycle $\leq 2\%$.



MMBT4401

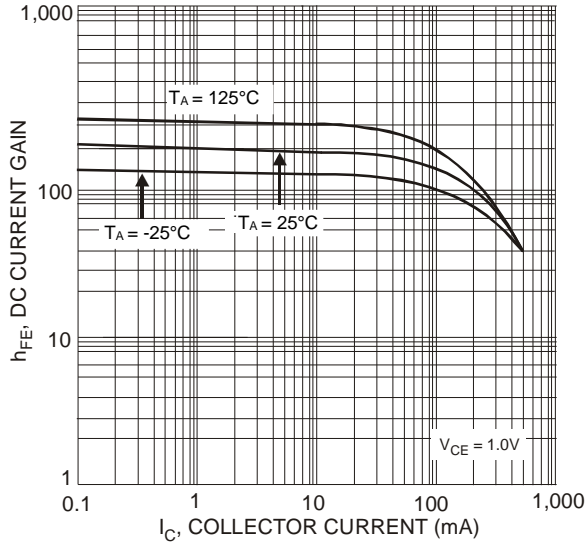

Figure 5 Typical DC Current Gain vs. Collector Current

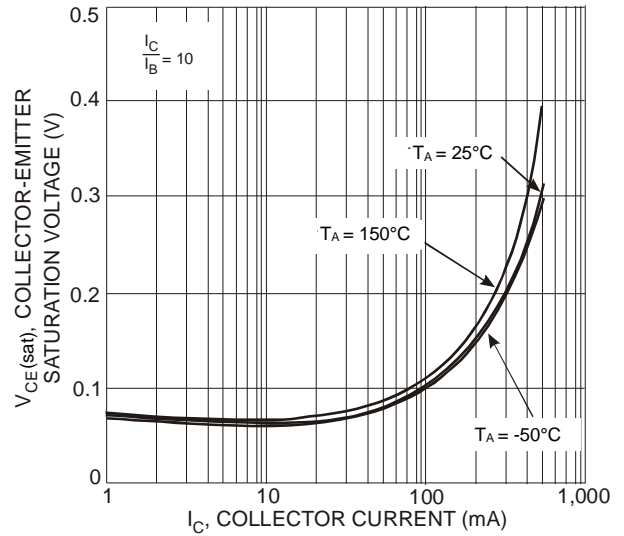

Figure 6 Collector-Emitter Saturation Voltage vs. Collector Current

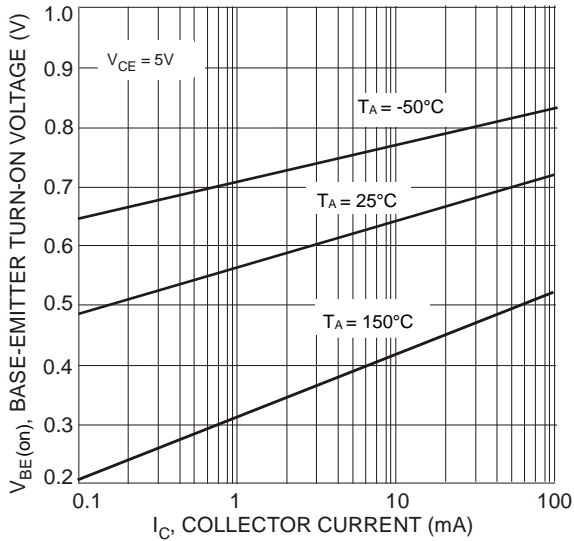

Figure 7 Typical Base-Emitter Turn-On Voltage vs. Collector Current

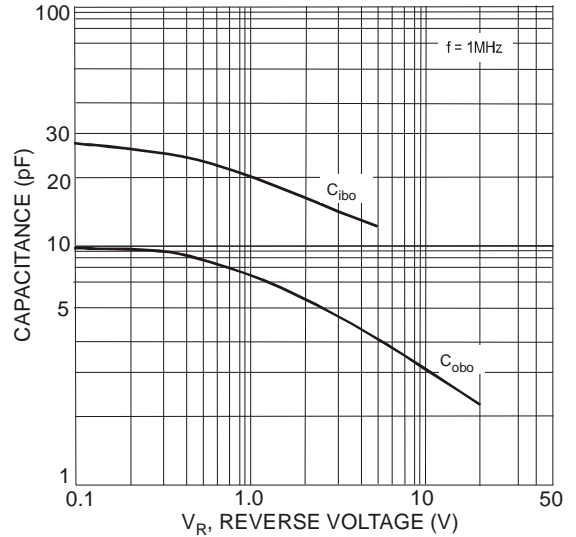

Figure 8 Typical Capacitance Characteristics

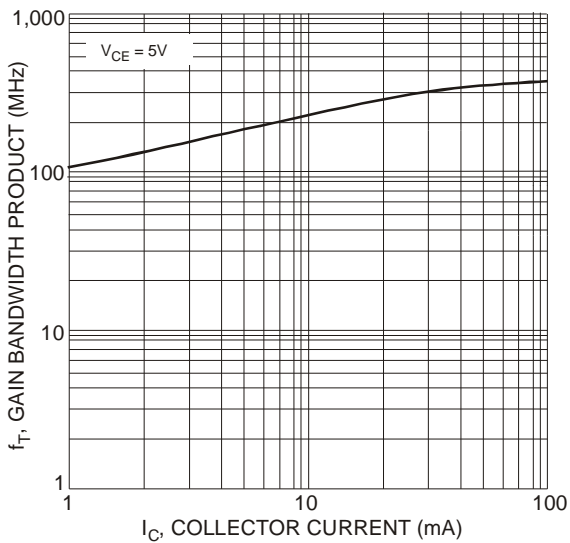

Figure 9 Typical Gain Bandwidth Product vs. Collector Current

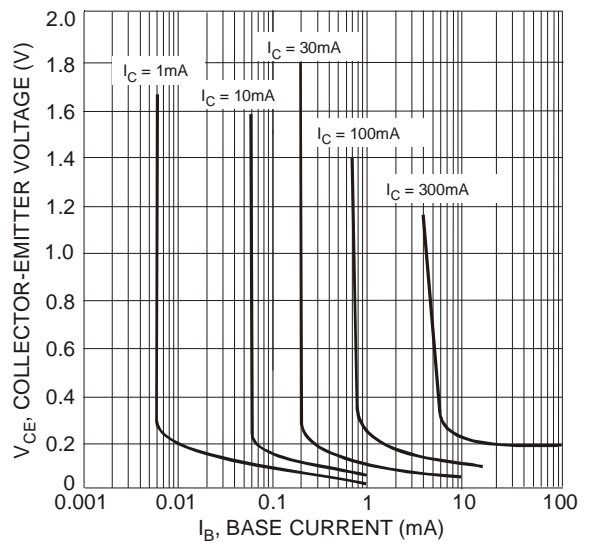
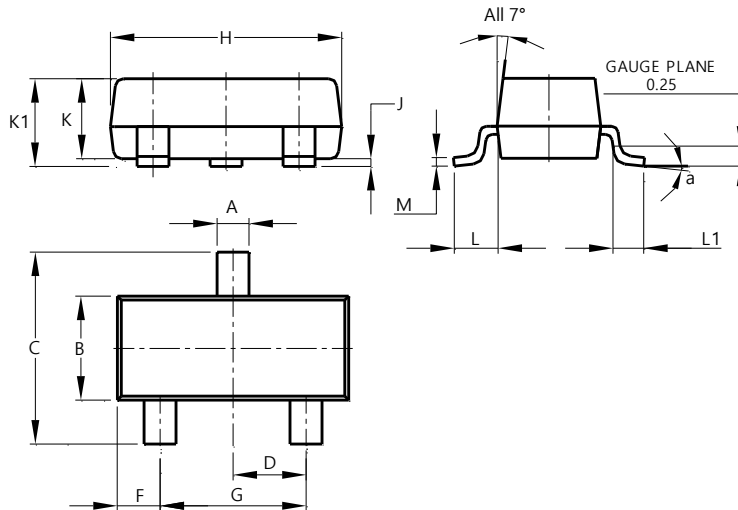

Figure 10 Typical Collector Saturation Region

Package Outline Dimensions

Please see <http://www.diodes.com/package-outlines.html> for the latest version.

SOT23



SOT23			
Dim	Min	Max	Typ
A	0.37	0.51	0.40
B	1.20	1.40	1.30
C	2.30	2.50	2.40
D	0.89	1.03	0.915
F	0.45	0.60	0.535
G	1.78	2.05	1.83
H	2.80	3.00	2.90
J	0.013	0.10	0.05
K	0.890	1.00	0.975
K1	0.903	1.10	1.025
L	0.45	0.61	0.55
L1	0.25	0.55	0.40
M	0.085	0.150	0.110
a	0°	8°	--
All Dimensions in mm			

Suggested Pad Layout

Please see <http://www.diodes.com/package-outlines.html> for the latest version.

SOT23

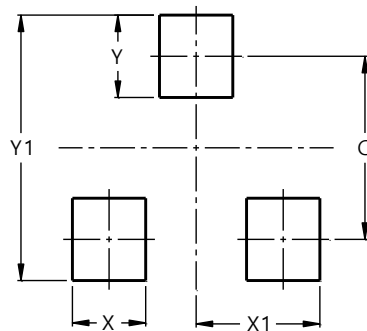

Dimensions	Value (in mm)
C	2.0
X	0.8
X1	1.35
Y	0.9
Y1	2.9

**IMPORTANT NOTICE**

1. DIODES INCORPORATED (Diodes) AND ITS SUBSIDIARIES MAKE NO WARRANTY OF ANY KIND, EXPRESS OR IMPLIED, WITH REGARDS TO ANY INFORMATION CONTAINED IN THIS DOCUMENT, INCLUDING, BUT NOT LIMITED TO, THE IMPLIED WARRANTIES OF MERCHANTABILITY, FITNESS FOR A PARTICULAR PURPOSE OR NON-INFRINGEMENT OF THIRD PARTY INTELLECTUAL PROPERTY RIGHTS (AND THEIR EQUIVALENTS UNDER THE LAWS OF ANY JURISDICTION).
2. The Information contained herein is for informational purpose only and is provided only to illustrate the operation of Diodes' products described herein and application examples. Diodes does not assume any liability arising out of the application or use of this document or any product described herein. This document is intended for skilled and technically trained engineering customers and users who design with Diodes' products. Diodes' products may be used to facilitate safety-related applications; however, in all instances customers and users are responsible for (a) selecting the appropriate Diodes products for their applications, (b) evaluating the suitability of Diodes' products for their intended applications, (c) ensuring their applications, which incorporate Diodes' products, comply the applicable legal and regulatory requirements as well as safety and functional-safety related standards, and (d) ensuring they design with appropriate safeguards (including testing, validation, quality control techniques, redundancy, malfunction prevention, and appropriate treatment for aging degradation) to minimize the risks associated with their applications.
3. Diodes assumes no liability for any application-related information, support, assistance or feedback that may be provided by Diodes from time to time. Any customer or user of this document or products described herein will assume all risks and liabilities associated with such use, and will hold Diodes and all companies whose products are represented herein or on Diodes' websites, harmless against all damages and liabilities.
4. Products described herein may be covered by one or more United States, international or foreign patents and pending patent applications. Product names and markings noted herein may also be covered by one or more United States, international or foreign trademarks and trademark applications. Diodes does not convey any license under any of its intellectual property rights or the rights of any third parties (including third parties whose products and services may be described in this document or on Diodes' website) under this document.
5. Diodes' products are provided subject to Diodes' Standard Terms and Conditions of Sale (<https://www.diodes.com/about/company/terms-and-conditions/terms-and-conditions-of-sales/>) or other applicable terms. This document does not alter or expand the applicable warranties provided by Diodes. Diodes does not warrant or accept any liability whatsoever in respect of any products purchased through unauthorized sales channel.
6. Diodes' products and technology may not be used for or incorporated into any products or systems whose manufacture, use or sale is prohibited under any applicable laws and regulations. Should customers or users use Diodes' products in contravention of any applicable laws or regulations, or for any unintended or unauthorized application, customers and users will (a) be solely responsible for any damages, losses or penalties arising in connection therewith or as a result thereof, and (b) indemnify and hold Diodes and its representatives and agents harmless against any and all claims, damages, expenses, and attorney fees arising out of, directly or indirectly, any claim relating to any noncompliance with the applicable laws and regulations, as well as any unintended or unauthorized application.
7. While efforts have been made to ensure the information contained in this document is accurate, complete and current, it may contain technical inaccuracies, omissions and typographical errors. Diodes does not warrant that information contained in this document is error-free and Diodes is under no obligation to update or otherwise correct this information. Notwithstanding the foregoing, Diodes reserves the right to make modifications, enhancements, improvements, corrections or other changes without further notice to this document and any product described herein. This document is written in English but may be translated into multiple languages for reference. Only the English version of this document is the final and determinative format released by Diodes.
8. Any unauthorized copying, modification, distribution, transmission, display or other use of this document (or any portion hereof) is prohibited. Diodes assumes no responsibility for any losses incurred by the customers or users or any third parties arising from any such unauthorized use.
9. This Notice may be periodically updated with the most recent version available at <https://www.diodes.com/about/company/terms-and-conditions/important-notice>

The Diodes logo is a registered trademark of Diodes Incorporated in the United States and other countries.
All other trademarks are the property of their respective owners.
© 2023 Diodes Incorporated. All Rights Reserved.

www.diodes.com

OUR CERTIFICATE

DiGi provide top-quality products and perfect service for customer worldwide through standardization, technological innovation and continuous improvement. DiGi through third-party certification, we stricly control the quality of products and services. Welcome your RFQ to

Email: Info@DiGi-Electronics.com



Tel: +00 852-30501935

RFQ Email: Info@DiGi-Electronics.com

DiGi is a global authorized distributor of electronic components.