

# PI6C2405A-1HWEX Datasheet

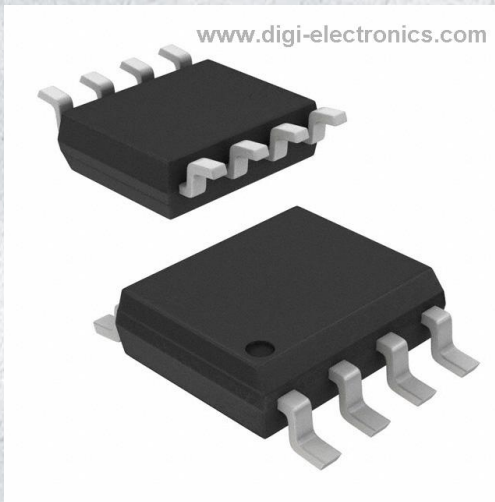

<https://www.DiGi-Electronics.com>

DiGi Electronics Part Number	PI6C2405A-1HWEX-DG
Manufacturer	<a href="#">Diodes Incorporated</a>
Manufacturer Product Number	PI6C2405A-1HWEX
Description	IC ZD BUFFER 8SOIC
Detailed Description	Zero Delay Buffer IC 133MHz 1 8-SOIC (0.154", 3.90 mm Width)



Tel: +00 852-30501935

RFQ Email: [Info@DiGi-Electronics.com](mailto:Info@DiGi-Electronics.com)

DiGi is a global authorized distributor of electronic components.

## Purchase and inquiry

Manufacturer Product Number:

PI6C2405A-1HWEX

Series:

-

DiGi-Electronics Programmable:

Not Verified

PLL:

Yes

Output:

TTL

Ratio - Input:Output:

1:5

Frequency - Max:

133MHz

Voltage - Supply:

3V ~ 3.6V

Mounting Type:

Surface Mount

Supplier Device Package:

8-SOIC

Manufacturer:

Diodes Incorporated

Product Status:

Last Time Buy

Type:

Zero Delay Buffer

Input:

TTL

Number of Circuits:

1

Differential - Input:Output:

No/No

Divider/Multiplier:

No/No

Operating Temperature:

0°C ~ 70°C

Package / Case:

8-SOIC (0.154", 3.90mm Width)

Base Product Number:

PI6C2405

## Environmental & Export classification

RoHS Status:

ROHS3 Compliant

REACH Status:

REACH Unaffected

HTSUS:

8542.39.0001

Moisture Sensitivity Level (MSL):

1 (Unlimited)

ECCN:

EAR99





A Product Line of  
Diodes Incorporated



**PI6C2405A-1/PI6C2405A-1H**

## Zero-Delay Clock Buffer

### Features

- Maximum rated frequency: 133 MHz
- Low cycle-to-cycle jitter
- Input to output delay, less than 300ps
- Internal feedback allows outputs to be synchronized to the clock input
- 5V tolerant input\*
- Spread spectrum clock ready
- Operates at 3.3V  $V_{DD}$
- Totally Lead-Free & Fully RoHS Compliant (Notes 1 & 2)
- Halogen and Antimony Free. "Green" Device (Note 3)
- For automotive applications requiring specific change control (i.e. parts qualified to AEC-Q100/101/200, PPAP capable, and manufactured in IATF 16949 certified facilities), please [contact us](#) or your local Diodes representative.  
<https://www.diodes.com/quality/product-definitions/>
- Packaging (Pb-free & Green available):
  - 8-pin, 150-mil SOIC (W)
  - 8-pin, 173-mil TSSOP (L)

\*  $CLKIN$  must reference the same voltage thresholds for the PLL to deliver zero delay skewing

### Description

The PI6C2405A-1/PI6C2405A-1H is a PLL based, zero-delay buffer, with the ability to distribute five outputs of up to 133MHz at 3.3V. All the outputs are distributed from a single clock input  $CLKIN$  and output  $OUT_0$  performs zero delay by connecting a feedback to PLL.

An internal feedback on  $OUT_0$  is used to synchronize the outputs to the input; the relationship between loading of this signal and the outputs determines the input-output delay. PI6C2405A-1/PI6C2405A-1H is able to track spread spectrum clocking for EMI reduction. PI6C2405A-1/PI6C2405A-1H is characterized for both commercial and industrial operation.

PI6C2405A-1H is a high-drive version of PI6C2405A-1.

### Block Diagram

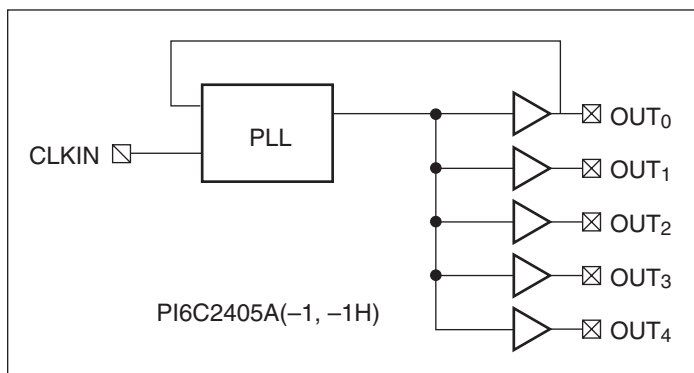

#### Notes:

1. No purposely added lead. Fully EU Directive 2002/95/EC (RoHS), 2011/65/EU (RoHS 2) & 2015/863/EU (RoHS 3) compliant.
2. See <https://www.diodes.com/quality/lead-free/> for more information about Diodes Incorporated's definitions of Halogen- and Antimony-free, "Green" and Lead-free.
3. Halogen- and Antimony-free "Green" products are defined as those which contain <900ppm bromine, <900ppm chlorine (<1500ppm total Br + Cl) and <1000ppm antimony compounds.



A Product Line of  
Diodes Incorporated



PI6C2405A-1/PI6C2405A-1H

## Pin Configuration

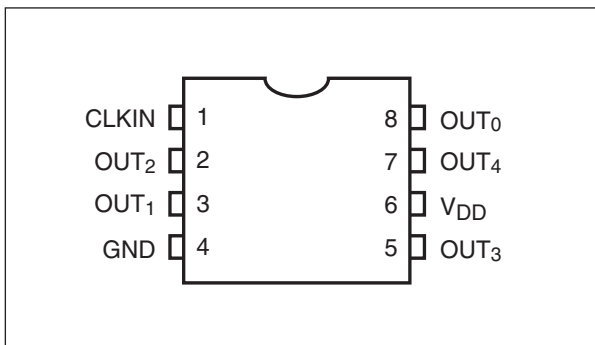

## Pin Description

Pin#	Pin Name	Description
1	CLKIN	Input clock reference frequency (weak pull-down)
2, 3, 5, 7	OUT[1-4]	Clock Outputs
4	GND	Ground
6	V <sub>DD</sub>	3.3V Supply
8	OUT0	Clock output, internal PLL feedback (weak pull-down)



A Product Line of  
Diodes Incorporated



PI6C2405A-1/PI6C2405A-1H

### Zero Delay and Skew Control

CLKIN Input to OUTx Delay vs. Difference in Loading between OUT0 pin and OUTx pins

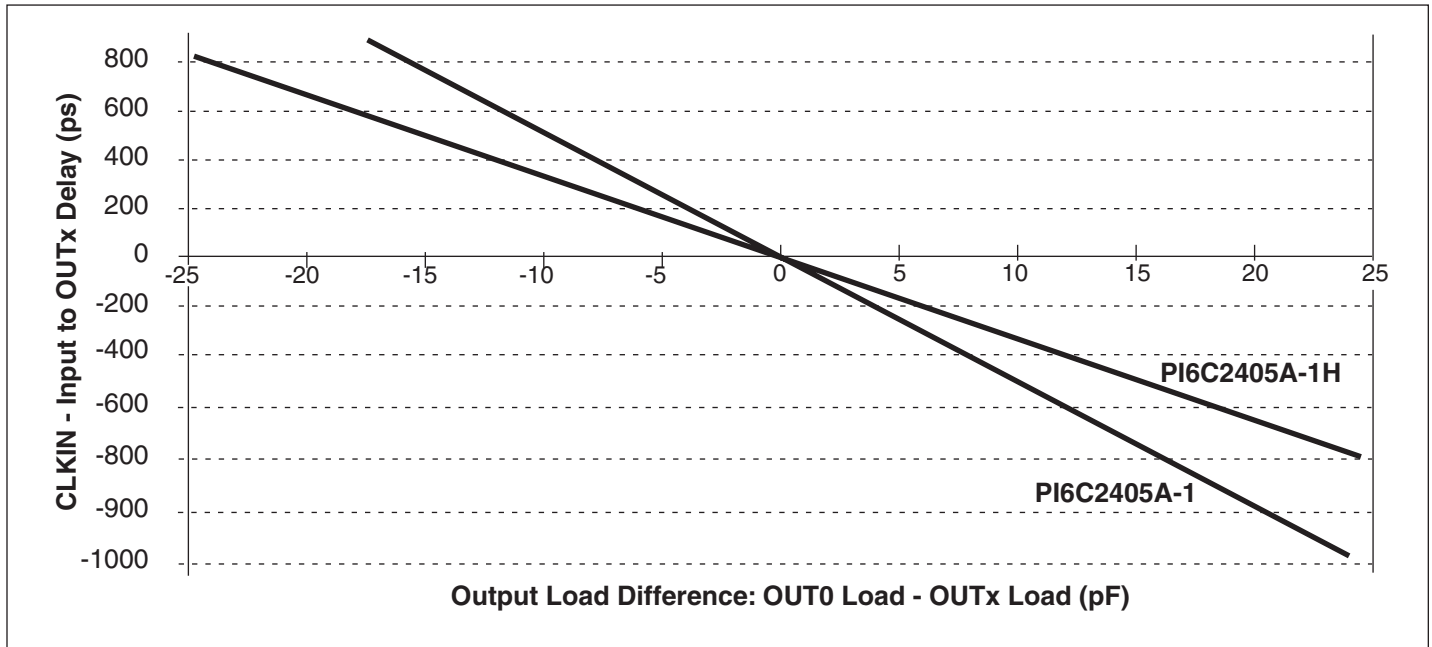

The relationship between loading of the OUT0 signal and other outputs determines the input-output delay. Zero delay is achieved when all outputs, including feedback, are loaded equally.



A Product Line of  
Diodes Incorporated



PI6C2405A-1/PI6C2405A-1H

## Maximum Ratings

(Above which useful life may be impaired. For user guidelines, not tested.)

Storage Temperature.....	-65°C to +150°C
Junction Temperature .....	+125°C Max.
Supply Voltage to Ground Potential.....	-0.5V to +4.6V
DC Input Voltage (Except CLKIN).....	-0.5V to $V_{DD} + 5.5V$
ESD Protection (Input) .....	2000 V min (HBM)

### Note:

Stresses greater than those listed under MAXIMUM RATINGS may cause permanent damage to the device. This is a stress rating only and functional operation of the device at these or any other conditions above those indicated in the operational sections of this specification is not implied. Exposure to absolute maximum rating conditions for extended periods may affect reliability.

## Operating Conditions ( $V_{CC} = 3.3V \pm 0.3V$ )

Parameter	Description	Min.	Max.	Units
$V_{DD}$	Supply Voltage	3.0	3.6	V
$T_A$	Commercial Operating Temperature	0	70	°C
	Industrial Operating Temperature	-40	85	
$C_L$	Load Capacitance, below 100 MHz		30	pF
	Load Capacitance, from 100 MHz to 133		15	
$C_{IN}$	Input Capacitance		7	

## DC Electrical Characteristics for Industrial Temperature Devices

Parameter	Description	Test Conditions	Min.	Max.	Units
$V_{IL}$	Input LOW Voltage			0.8	V
$V_{IH}$	Input HIGH Voltage		2.0		
$I_{IL}$	Input LOW Current	$V_{IN} = 0V$		50	$\mu A$
$I_{IH}$	Input HIGH Current	$V_{IN} = V_{DD}$		125	
$V_{OL}$	Output LOW Voltage	$I_{OL} = 8mA(-1); I_{OL} = 12mA(-1H)$		0.4	V
$V_{OH}$	Output HIGH Voltage	$I_{OH} = -8mA(-1); I_{OH} = -12mA(-1H)$	2.4		
$I_{DD}$	Supply Current	Unloaded outputs 100 MHz, Select inputs at $V_{DD}$ or GND		54	mA
		Unloaded outputs 66 MHz, CLKIN		39	



A Product Line of  
Diodes Incorporated



PI6C2405A-1/PI6C2405A-1H

### AC Electrical Characteristics for Industrial Temperature Devices

Parameter	Description	Test Conditions	Min.	Typ.	Max.	Units
F <sub>O</sub>	Output Frequency	30pF load	10		100	MHz
		15pF load	10		133	
t <sub>DC</sub>	Duty Cycle <sup>(1)</sup> (-1)	Measured at V <sub>DD</sub> /2, F <sub>OUT</sub> < 66.67MHz, 30pF load	40	50	60	%
		Measured at V <sub>DD</sub> /2, F <sub>OUT</sub> < 45MHz 15pF load	45		55	
	Duty Cycle <sup>(1)</sup> (-1H)	Measured at V <sub>DD</sub> /2, F <sub>OUT</sub> < 100MHz 15pF load	40		60	
		Measured at V <sub>DD</sub> /2, F <sub>OUT</sub> < 45MHz 30pF load	45		55	
t <sub>R</sub>	Rise Time <sup>(1)</sup> (-1)	Measured between 0.8V and 2.0V, 30pF load			2.2	ns
		Measured between 0.8V and 2.0V, 15pF load			1.5	
	Rise Time <sup>(1)</sup> (-1H)	Measured between 0.8V and 2.0V, 30pF load			1.7	
t <sub>F</sub>	Fall Time <sup>(1)</sup> (-1)	Measured between 0.8V and 2.0V, 30pF load			2.2	
		Measured between 0.8V and 2.0V, 15pF load			1.5	
	Fall Time <sup>(1)</sup> (-1H)	Measured between 0.8V and 2.0V, 30pF load			1.5	
t <sub>sk(o)</sub>	Output to Output skew (-1, -1H) <sup>(1)</sup>	All outputs equally loaded			200	
t <sub>0</sub>	Delay, CLKIN Rising Edge to OUT0 Rising Edge <sup>(1)</sup>	Measured at V <sub>DD</sub> /2		0	±300	ps
t <sub>SK(D)</sub>	Device-to-device skew <sup>(1)</sup>	Measured at V <sub>DD</sub> /2 on OUT0 pins of device		0	600	
t <sub>SLEW</sub>	Output slew rate <sup>(1)</sup>	Measured between 0.8V and 2.0V on -1H device using Test Circuit #2	1			V/ns
t <sub>JIT</sub>	Cycle-to-Cycle Jitter (-1, -1H)	Measured at 66.67 MHz, loaded 30pF load			200	ps
t <sub>LOCK</sub>	PLL Lock time <sup>(1)</sup>	Stable power supply, valid clocks presented on CLKIN pin			1.0	ms

**Notes:**

1. See Switching Waveforms on page 6.

### DC Electrical Characteristics for Commercial Temperature Devices

Parameter	Description	Test Conditions	Min.	Max.	Units
V <sub>IL</sub>	Input LOW Voltage			0.8	V
V <sub>IH</sub>	Input HIGH Voltage		2.0		
I <sub>IL</sub>	Input LOW Current	V <sub>IN</sub> = 0V		50	μA
I <sub>IH</sub>	Input HIGH Current	V <sub>IN</sub> = V <sub>DD</sub>		125	
V <sub>OL</sub>	Output LOW Voltage	I <sub>OL</sub> = -8mA(-1); I <sub>OL</sub> = 12mA(-1H)		0.4	V
V <sub>OH</sub>	Output HIGH Voltage	I <sub>OH</sub> = -8mA(-1); I <sub>OH</sub> = -12mA(-1H)	2.4		
I <sub>DD</sub>	Supply Current	Unloaded outputs 100 MHz, Select inputs at V <sub>DD</sub> or GND		54	mA
		Unloaded outputs 66.67 MHz, select inputs at V <sub>DD</sub> or GND		39	



A Product Line of  
Diodes Incorporated



PI6C2405A-1/PI6C2405A-1H

### AC Electrical Characteristics for Commercial Temperature Devices

Parameter	Description	Test Conditions	Min.	Typ.	Max.	Units
F <sub>O</sub>	Output Frequency	30pF load	10		100	MHz
		15pF load	10		133	
t <sub>DC</sub>	Duty Cycle <sup>(1)</sup> (-1)	Measured at V <sub>DD</sub> /2, F <sub>O</sub> < 66 MHz, 30pF load	40	50	60	%
	Duty Cycle <sup>(1)</sup> (-1H)	Measured at V <sub>DD</sub> /2, F <sub>O</sub> < 66 MHz, 30pF load	45	50	55	
t <sub>R</sub>	Rise Time <sup>(1)</sup> @ 30pF	Measured between 0.8V and 2.0V			2.2	ns
	Rise Time <sup>(1)</sup> @ 15pF				1.5	
	Rise Time <sup>(1)</sup> @ 30pF (-1H)				1.5	
t <sub>F</sub>	Fall Time <sup>(1)</sup> @ 30pF	Measured between 0.8V and 2.0V			2.2	ns
	Fall Time <sup>(1)</sup> @ 15pF				1.5	
	Fall Time <sup>(1)</sup> @ 30pF (-1H)				1.5	
t <sub>sk(o)</sub>	Output to Output skew (-1, -1H) <sup>(1)</sup>	All outputs equally loaded			200	ps
t <sub>0</sub>	Input to output delay, CLKIN Rising Edge to OUT0 Rising Edge <sup>(1)</sup>	Measured at V <sub>DD</sub> /2		0	±300	
t <sub>SK(D)</sub>	Device-to-device skew <sup>(1)</sup>	Measured at V <sub>DD</sub> /2 on OUT0 pins of device		0	600	
t <sub>SLEW</sub>	Output slew rate <sup>(1)</sup>	Measured between 0.8V and 2.0V on -1H device using Test Circuit #2	1			V/ns
t <sub>JIT</sub>	Cycle-to-Cycle Jitter (-1, -1H)	Measured at 66.67 MHz, loaded 30pF load			200	ps
t <sub>LOCK</sub>	PLL Lock time <sup>(1)</sup>	Stable power supply, valid clocks presented on CLKIN pin			1.0	ms

**Notes:**

1. See Switching Waveforms on page 6.





A Product Line of  
Diodes Incorporated



PI6C2405A-1/PI6C2405A-1H

### Switching Waveforms

Duty Cycle Timing

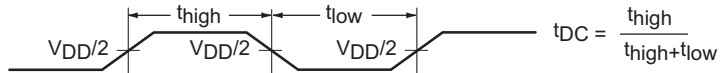

All Outputs Rise/Fall Time

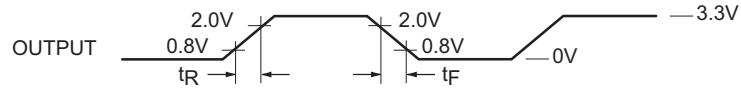

Output-Output Skew

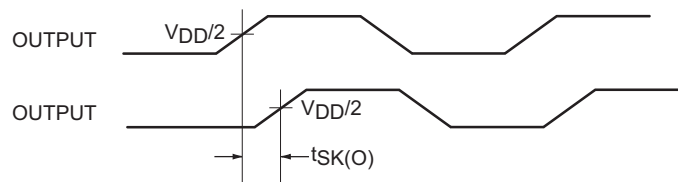

Device-Device Skew

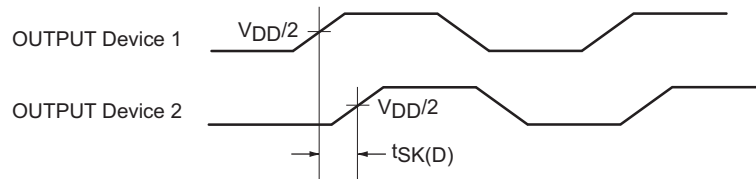

Input-Output Propagation Delay

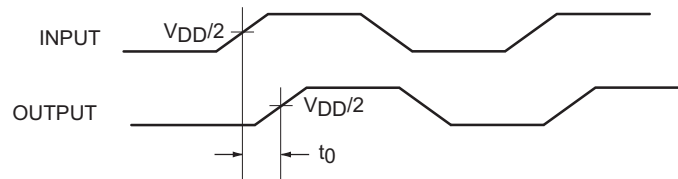

Test Circuit 1

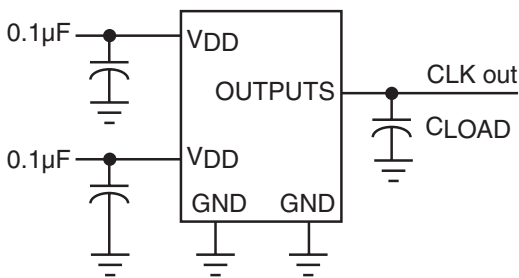

Test Circuit for all parameters except  $t_{SLEW}$

Test Circuit 2

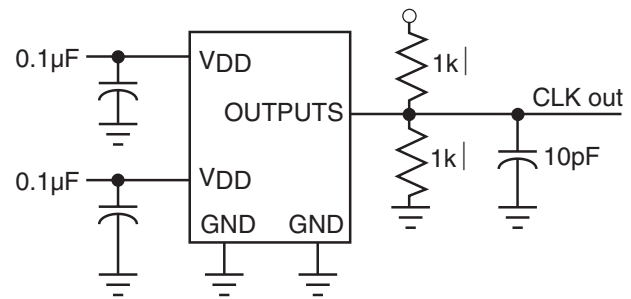

Test Circuit for  $t_{SLEW}$ , Output slew rate on -1H device



A Product Line of  
Diodes Incorporated



**PI6C2405A-1/PI6C2405A-1H**

**Part Marking**

**L Package**

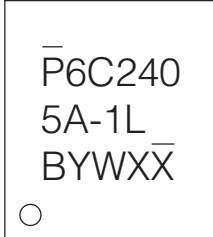

PI6C2405A-1LE  
B: Fab Port Code  
Y: Year  
W: Workweek  
1st X: Assembly Code  
2nd X: Fab Code

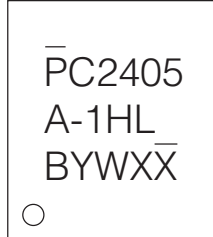

PI6C2405A-1HLE  
B: Fab Port Code  
Y: Year  
W: Workweek  
1st X: Assembly Code  
2nd X: Fab Code

**W Package**

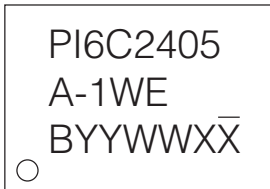

PI6C2405A-1WE  
B: Fab Port Code  
YY: Year  
WW: Workweek  
1st X: Assembly Code  
2nd X: FabCode

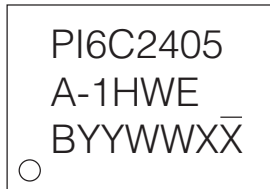

PI6C2405A-1HWE  
B: Fab Port Code  
YY: Year  
WW: Workweek  
1st X: Assembly Code  
2nd X: FabCode

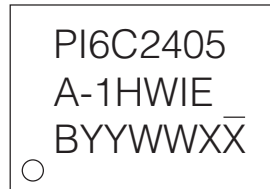

PI6C2405A-1HWIE  
B: Fab Port Code  
YY: Year  
WW: Workweek  
1st X: Assembly Code  
2nd X: FabCode



A Product Line of  
Diodes Incorporated



PI6C2405A-1/PI6C2405A-1H

**Packaging Mechanical: 8-SOIC (W)**

SYMBOLS	MIN.	NOM.	MAX.
A	—	—	1.75
A1	0.10	—	0.25
A2	1.25	—	—
b	0.31	—	0.51
c	0.10	—	0.25
D	4.80	4.90	5.00
E	5.80	6.00	6.20
E1	3.80	3.90	4.00
e	1.27 BSC		
L	0.40	—	1.27
h	0.25	—	0.50
θ°	0	—	8

Recommended Land Pattern

**NOTE :**  
 1. ALL DIMENSIONS ARE IN mm. ANGLES IN DEGREES  
 2. DIMENSIONS EXCLUDE BURRS, MOLD FLASH OR PROTRUSIONS  
 3. REFER JEDEC MS-012  
 4. RECOMMENDED LAND PATTERN IS FOR REFERENCE ONLY.

20-1273

		DATE: 06/02/20
DESCRIPTION: 8-Pin, 150mil-Wide, SOIC		
PACKAGE CODE: W (W8)		
DOCUMENT CONTROL #: PD-1001	REVISION: H	



A Product Line of  
Diodes Incorporated



**PI6C2405A-1/PI6C2405A-1H**

**Packaging Mechanical: 8-TSSOP (L)**

SYMBOLS	MIN.	NOM.	MAX.
A	—	—	1.20
A1	0.05	—	0.15
A2	0.80	1.00	1.05
b	0.19	—	0.30
c	0.09	—	0.20
D	2.90	3.00	3.10
E	6.20	6.40	6.60
e	0.65 BSC		
E1	4.30	4.40	4.50
L	0.45	0.60	0.75
L1	1.00 REF		
S	0.20	—	—
θ°	0	—	8

UNIT : MM

**NOTES:**  
 1. ALL DIMENSIONS IN MILLIMETERS. ANGLES IN DEGREES.  
 2. JEDEC MO-153F/AA  
 3. DIMENSIONS DOES NOT INCLUDE MOLD FLASH, PROTRUSIONS OR GATE BURRS.

<b>PERICOM</b> Enabling Serial Connectivity	DATE: 03/24/16
<b>DESCRIPTION: 8-Pin, 173mil Wide TSSOP</b>	
<b>PACKAGE CODE: L (L8)</b>	
<b>DOCUMENT CONTROL #: PD-1308</b>	<b>REVISION: G</b>

16-0062

**For latest package info.**

please check: <http://www.diodes.com/design/support/packaging/pericom-packaging/packaging-mechanicals-and-thermal-characteristics/>



A Product Line of  
Diodes Incorporated



**PI6C2405A-1/PI6C2405A-1H**

## Ordering Information

Ordering Code	Package Code	Package Description
PI6C2405A-1HWEX	W	8-pin, 150-mil wide (SOIC)
PI6C2405A-1HLEX	L	8-pin, 173-mil wide (TSSOP)
PI6C2405A-1WEX	W	8-pin, 150-mil wide (SOIC)
PI6C2405A-1LEX	L	8-pin, 173-mil wide (TSSOP)
PI6C2405A-1HWIEX	W	8-pin, 150-mil wide (SOIC)

### Notes:

1. No purposely added lead. Fully EU Directive 2002/95/EC (RoHS), 2011/65/EU (RoHS 2) & 2015/863/EU (RoHS 3) compliant.
2. See <https://www.diodes.com/quality/lead-free/> for more information about Diodes Incorporated's definitions of Halogen- and Antimony-free, "Green" and Lead-free.
3. Halogen- and Antimony-free "Green" products are defined as those which contain <900ppm bromine, <900ppm chlorine (<1500ppm total Br + Cl) and <1000ppm antimony compounds.
4. I = Industrial
5. E = Pb-free and Green
6. X suffix = Tape/Reel





A Product Line of  
Diodes Incorporated



**PI6C2405A-1/PI6C2405A-1H**

#### IMPORTANT NOTICE

1. DIODES INCORPORATED AND ITS SUBSIDIARIES ("DIODES") MAKE NO WARRANTY OF ANY KIND, EXPRESS OR IMPLIED, WITH REGARDS TO ANY INFORMATION CONTAINED IN THIS DOCUMENT, INCLUDING, BUT NOT LIMITED TO, THE IMPLIED WARRANTIES OF MERCHANTABILITY, FITNESS FOR A PARTICULAR PURPOSE OR NON-INFRINGEMENT OF THIRD PARTY INTELLECTUAL PROPERTY RIGHTS (AND THEIR EQUIVALENTS UNDER THE LAWS OF ANY JURISDICTION).

2. The Information contained herein is for informational purpose only and is provided only to illustrate the operation of Diodes products described herein and application examples. Diodes does not assume any liability arising out of the application or use of this document or any product described herein. This document is intended for skilled and technically trained engineering customers and users who design with Diodes products. Diodes products may be used to facilitate safety-related applications; however, in all instances customers and users are responsible for (a) selecting the appropriate Diodes products for their applications, (b) evaluating the suitability of the Diodes products for their intended applications, (c) ensuring their applications, which incorporate Diodes products, comply the applicable legal and regulatory requirements as well as safety and functional-safety related standards, and (d) ensuring they design with appropriate safeguards (including testing, validation, quality control techniques, redundancy, malfunction prevention, and appropriate treatment for aging degradation) to minimize the risks associated with their applications.

3. Diodes assumes no liability for any application-related information, support, assistance or feedback that may be provided by Diodes from time to time. Any customer or user of this document or products described herein will assume all risks and liabilities associated with such use, and will hold Diodes and all companies whose products are represented herein or on Diodes' websites, harmless against all damages and liabilities.

4. Products described herein may be covered by one or more United States, international or foreign patents and pending patent applications. Product names and markings noted herein may also be covered by one or more United States, international or foreign trademarks and trademark applications. Diodes does not convey any license under any of its intellectual property rights or the rights of any third parties (including third parties whose products and services may be described in this document or on Diodes' website) under this document.

5. Diodes products are provided subject to Diodes' Standard Terms and Conditions of Sale (<https://www.diodes.com/about/company/terms-and-conditions/terms-and-conditions-of-sales/>) or other applicable terms. This document does not alter or expand the applicable warranties provided by Diodes. Diodes does not warrant or accept any liability whatsoever in respect of any products purchased through unauthorized sales channel.

6. Diodes products and technology may not be used for or incorporated into any products or systems whose manufacture, use or sale is prohibited under any applicable laws and regulations. Should customers or users use Diodes products in contravention of any applicable laws or regulations, or for any unintended or unauthorized application, customers and users will (a) be solely responsible for any damages, losses or penalties arising in connection therewith or as a result thereof, and (b) indemnify and hold Diodes and its representatives and agents harmless against any and all claims, damages, expenses, and attorney fees arising out of, directly or indirectly, any claim relating to any noncompliance with the applicable laws and regulations, as well as any unintended or unauthorized application.

7. While efforts have been made to ensure the information contained in this document is accurate, complete and current, it may contain technical inaccuracies, omissions and typographical errors. Diodes does not warrant that information contained in this document is error-free and Diodes is under no obligation to update or otherwise correct this information. Notwithstanding the foregoing, Diodes reserves the right to make modifications, enhancements, improvements, corrections or other changes without further notice to this document and any product described herein. This document is written in English but may be translated into multiple languages for reference. Only the English version of this document is the final and determinative format released by Diodes.

8. Any unauthorized copying, modification, distribution, transmission, display or other use of this document (or any portion hereof) is prohibited. Diodes assumes no responsibility for any losses incurred by the customers or users or any third parties arising from any such unauthorized use.

Copyright © 2021 Diodes Incorporated

[www.diodes.com](http://www.diodes.com)

## OUR CERTIFICATE

DiGi provide top-quality products and perfect service for customer worldwide through standardization, technological innovation and continuous improvement. DiGi through third-party certification, we stricly control the quality of products and services. Welcome your RFQ to

Email: [Info@DiGi-Electronics.com](mailto:Info@DiGi-Electronics.com)



Tel: +00 852-30501935

RFQ Email: [Info@DiGi-Electronics.com](mailto:Info@DiGi-Electronics.com)

DiGi is a global authorized distributor of electronic components.