

PSMAJ440A-13 Datasheet



<https://www.DiGi-Electronics.com>

DiGi Electronics Part Number	PSMAJ440A-13-DG
Manufacturer	Diodes Incorporated
Manufacturer Product Number	PSMAJ440A-13
Description	TVS DIODE 376VWM 602VC SMA
Detailed Description	602V Clamp 660mA Ipp Tvs Diode Surface Mount S MA

This model PSMAJ440A-13 is available at DiGi Electronics.

DiGi Electronics offers a global database of semiconductor and electronic component datasheets.

We welcome your inquiries regarding pricing, lead time, or other product-related questions.

 [Request a Quote](#)

 [Datasheet Search](#)



Tel: +00 852-30501935

RFQ Email: Info@DiGi-Electronics.com

DiGi is a global authorized distributor of electronic components.

Purchase and inquiry

Manufacturer Product Number:

PSMAJ440A-13

Series:

-

Type:

Zener

Voltage - Reverse Standoff (Typ):

376V

Voltage - Clamping (Max) @ Ipp:

602V

Power - Peak Pulse:

400W

Applications:

General Purpose

Operating Temperature:

-55°C ~ 150°C (Tj)

Package / Case:

DO-214AC, SMA

Base Product Number:

PSMAJ440

Manufacturer:

Diodes Incorporated

Product Status:

Active

Unidirectional Channels:

1

Voltage - Breakdown (Min):

418V

Current - Peak Pulse (10/1000µs):

660mA

Power Line Protection:

No

Capacitance @ Frequency:

-

Mounting Type:

Surface Mount

Supplier Device Package:

SMA

Environmental & Export classification

RoHS Status:

ROHS3 Compliant

REACH Status:

REACH Unaffected

HTSUS:

8541.10.0080

Moisture Sensitivity Level (MSL):

1 (Unlimited)

ECCN:

EAR99



PSMAJ440A

400W SURFACE MOUNT TRANSIENT VOLTAGE SUPPRESSOR

Features

- 400W Peak Pulse Power Dissipation
- Excellent Clamping Capability
- Fast Response Time
- **Lead-Free Finish; RoHS Compliant (Notes 1 & 2)**
- **Halogen and Antimony Free. "Green" Device (Note 3)**

Mechanical Data

- Case: SMA
- Case Material: Molded Plastic. UL Flammability Classification Rating 94V-0
- Moisture Sensitivity: Level 1 per J-STD-020
- Terminals: Lead-Free Plating (Matte Tin Finish) Solderable per MIL-STD-202, Method 208 Ⓔ③
- Polarity Indicator: Cathode Band
- Weight: 0.064 grams (Approximate)

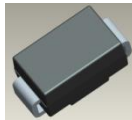

Top View

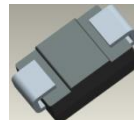

Bottom View

Ordering Information (Note 4)

Part Number	Case	Packaging
PSMAJ440A-13	SMA	5000/Tape & Reel

- Notes:
1. EU Directive 2002/95/EC (RoHS) & 2011/65/EU (RoHS 2) compliant. All applicable RoHS exemptions applied.
 2. See http://www.diodes.com/quality/lead_free.html for more information about Diodes Incorporated's definitions of Halogen- and Antimony-free, "Green" and Lead-free.
 3. Halogen- and Antimony-free "Green" products are defined as those which contain <900ppm bromine, <900ppm chlorine (<1500ppm total Br + Cl) and <1000ppm antimony compounds.
 4. For packaging details, go to our website at <http://www.diodes.com/products/packages.html>.

Marking Information

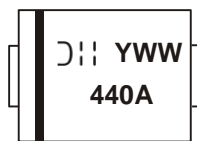

440A = Product Type Marking Code
 ⓂⓂ = Manufacturers' Code Marking
 YWW = Date Code Marking
 Y = Last Digit of Year (ex: 2 for 2012)
 WW = Week code (01 to 53)

Maximum Ratings (@T_A = +25°C, unless otherwise specified.)

Characteristic	Symbol	Value	Unit
Peak Pulse Power Dissipation (Non-repetitive current pulse derated above T _A = +25°C, T _P = 1ms) (Note 5)	P _{PK}	400	W
Peak Forward Surge Current, 8.3ms Single Half Sine-Wave Superimposed on Rated Load (Note 6)	I _{FSM}	40	A
Steady State Power Dissipation @ T _L = +120°C	PM _(AV)	1.0	W
Instantaneous Forward Voltage @ I _{PP} = 25A (Note 6)	V _F	6.5	V

- Notes:
5. Non-repetitive current pulse, per Figure 4 and derated above T_A = +25°C, per Figure 1.
 6. Measured with 8.3ms single half sine-wave. Duty cycle = 4 pulses per minute maximum.



PSMAJ440A

Thermal Characteristics

Characteristic	Symbol	Value	Unit
Operating Temperature Range	T_J	-55 to +150	°C
Storage Temperature Range	T_{STG}	-55 to +175	°C

Electrical Characteristics (@ $T_A = +25^\circ\text{C}$, unless otherwise specified.)

Part Number	Reverse Standoff Voltage	Breakdown Voltage V_{BR} @ I_T (Note 7)		Test Current	Max. Reverse Leakage @ V_{RWM}	Max. Clamping Voltage @ I_{pp} ($t_p = 10 \times 1000 \mu\text{s}$) (see Figure 4)	Max. Peak Pulse Current I_{pp}	Marking Code
	V_{RWM} (V)	Min (V)	Max (V)	I_T (mA)	I_R (μA)	V_C (V)	(A)	
PSMAJ440A	376	418	462	1.0	5.0	602.0	0.66	440A

Notes: 7. V_{BR} measured with I_T current pulse = 10 ~ 15 ms.

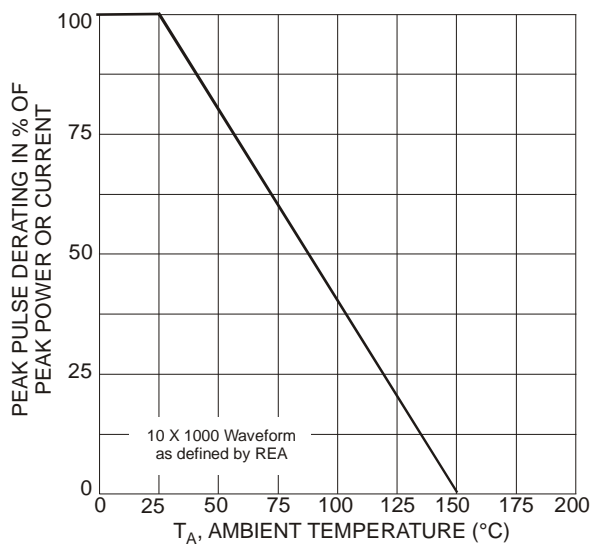

Figure 1 Pulse Derating Curve

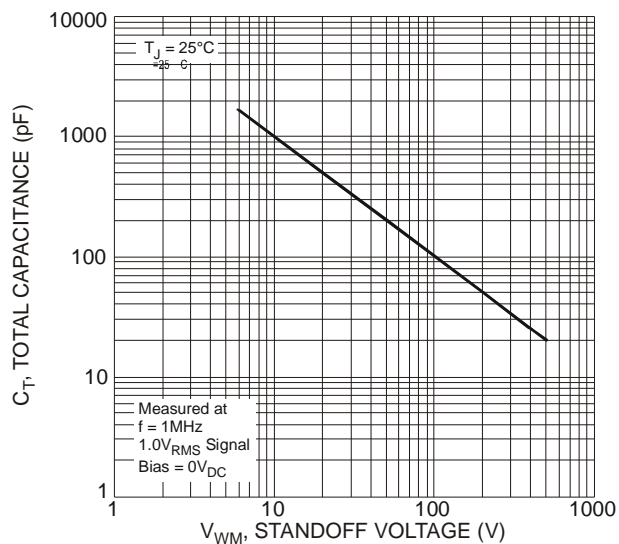

Figure 2 Typical Total Capacitance

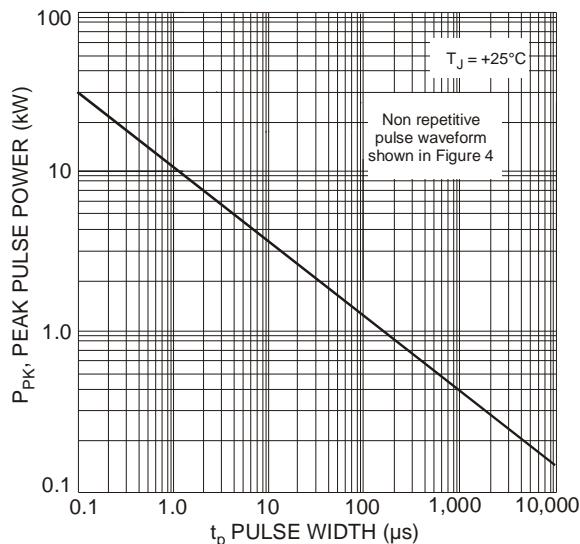

Figure 3 Pulse Rating Curve

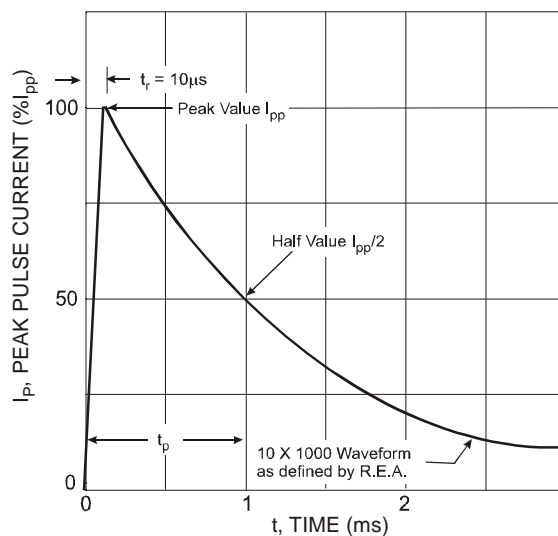
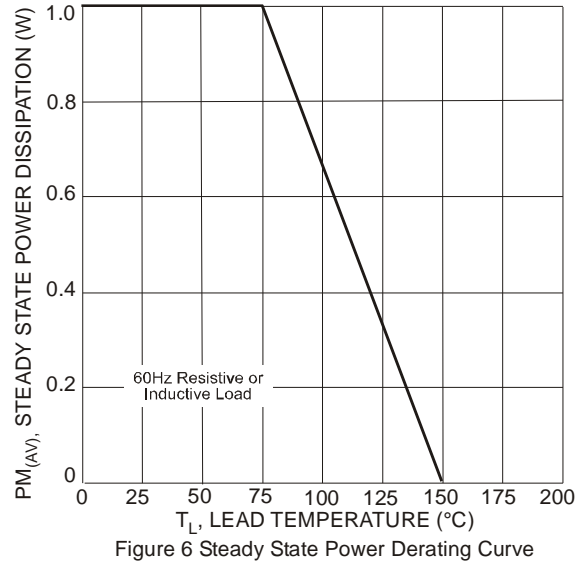
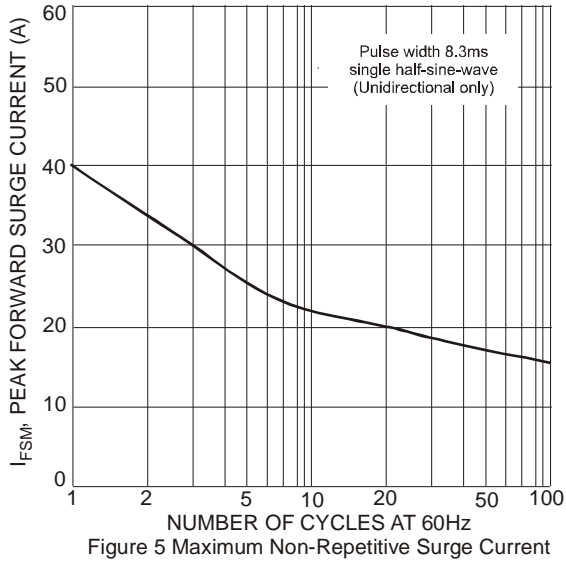

Figure 4 Pulse Waveform



PSMAJ440A



Package Outline Dimensions

Please see AP02002 at <http://www.diodes.com/datasheets/ap02002.pdf> for the latest version.

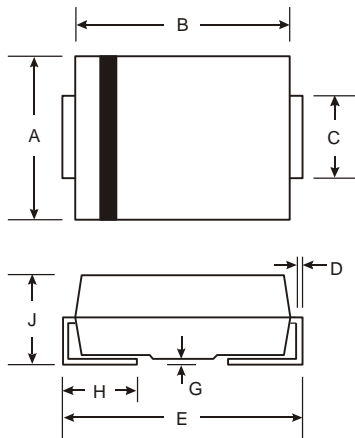

SMA		
Dim	Min	Max
A	2.29	2.92
B	4.00	4.60
C	1.27	1.63
D	0.15	0.31
E	4.80	5.59
G	0.05	0.20
H	0.76	1.52
J	2.01	2.30
All Dimensions in mm		

Suggested Pad Layout

Please see AP02001 at <http://www.diodes.com/datasheets/ap02001.pdf> for latest version.

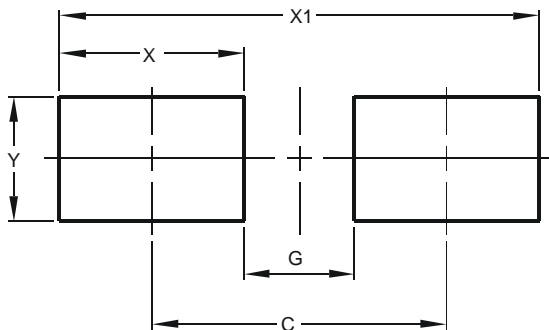

Dimensions	Value (in mm)
C	4.00
G	1.50
X	2.50
X1	6.50
Y	1.70



IMPORTANT NOTICE

DIODES INCORPORATED MAKES NO WARRANTY OF ANY KIND, EXPRESS OR IMPLIED, WITH REGARDS TO THIS DOCUMENT, INCLUDING, BUT NOT LIMITED TO, THE IMPLIED WARRANTIES OF MERCHANTABILITY AND FITNESS FOR A PARTICULAR PURPOSE (AND THEIR EQUIVALENTS UNDER THE LAWS OF ANY JURISDICTION).

Diodes Incorporated and its subsidiaries reserve the right to make modifications, enhancements, improvements, corrections or other changes without further notice to this document and any product described herein. Diodes Incorporated does not assume any liability arising out of the application or use of this document or any product described herein; neither does Diodes Incorporated convey any license under its patent or trademark rights, nor the rights of others. Any Customer or user of this document or products described herein in such applications shall assume all risks of such use and will agree to hold Diodes Incorporated and all the companies whose products are represented on Diodes Incorporated website, harmless against all damages.

Diodes Incorporated does not warrant or accept any liability whatsoever in respect of any products purchased through unauthorized sales channel. Should Customers purchase or use Diodes Incorporated products for any unintended or unauthorized application, Customers shall indemnify and hold Diodes Incorporated and its representatives harmless against all claims, damages, expenses, and attorney fees arising out of, directly or indirectly, any claim of personal injury or death associated with such unintended or unauthorized application.

Products described herein may be covered by one or more United States, international or foreign patents pending. Product names and markings noted herein may also be covered by one or more United States, international or foreign trademarks.

This document is written in English but may be translated into multiple languages for reference. Only the English version of this document is the final and determinative format released by Diodes Incorporated.

LIFE SUPPORT

Diodes Incorporated products are specifically not authorized for use as critical components in life support devices or systems without the express written approval of the Chief Executive Officer of Diodes Incorporated. As used herein:

A. Life support devices or systems are devices or systems which:

1. are intended to implant into the body, or
2. support or sustain life and whose failure to perform when properly used in accordance with instructions for use provided in the labeling can be reasonably expected to result in significant injury to the user.

B. A critical component is any component in a life support device or system whose failure to perform can be reasonably expected to cause the failure of the life support device or to affect its safety or effectiveness.

Customers represent that they have all necessary expertise in the safety and regulatory ramifications of their life support devices or systems, and acknowledge and agree that they are solely responsible for all legal, regulatory and safety-related requirements concerning their products and any use of Diodes Incorporated products in such safety-critical, life support devices or systems, notwithstanding any devices- or systems-related information or support that may be provided by Diodes Incorporated. Further, Customers must fully indemnify Diodes Incorporated and its representatives against any damages arising out of the use of Diodes Incorporated products in such safety-critical, life support devices or systems.

Copyright © 2014, Diodes Incorporated

www.diodes.com

OUR CERTIFICATE

DiGi provide top-quality products and perfect service for customer worldwide through standardization, technological innovation and continuous improvement. DiGi through third-party certification, we stricly control the quality of products and services. Welcome your RFQ to

Email: Info@DiGi-Electronics.com



Tel: +00 852-30501935

RFQ Email: Info@DiGi-Electronics.com

DiGi is a global authorized distributor of electronic components.