

ZTX415STZ Datasheet

www.digi-electronics.com



<https://www.DiGi-Electronics.com>

DiGi Electronics Part Number	ZTX415STZ-DG
Manufacturer	Diodes Incorporated
Manufacturer Product Number	ZTX415STZ
Description	TRANS NPN 100V 0.5A E-LINE
Detailed Description	Bipolar (BJT) Transistor NPN - Avalanche Mode 100 V 500 mA 40MHz 680 mW Through Hole E-Line (TO-92 compatible)



Tel: +00 852-30501935

RFQ Email: Info@DiGi-Electronics.com

DiGi is a global authorized distributor of electronic components.

Purchase and inquiry

Manufacturer Product Number:

ZTX415STZ

Series:

-

Transistor Type:

NPN - Avalanche Mode

Voltage - Collector Emitter Breakdown (Max):

100 V

Current - Collector Cutoff (Max):

100nA (ICBO)

Power - Max:

680 mW

Operating Temperature:

-55°C ~ 175°C (TJ)

Package / Case:

E-Line-3, Formed Leads

Base Product Number:

ZTX415

Manufacturer:

Diodes Incorporated

Product Status:

Active

Current - Collector (Ic) (Max):

500 mA

Vce Saturation (Max) @ Ib, Ic:

500mV @ 1mA, 10mA

DC Current Gain (hFE) (Min) @ Ic, Vce:

25 @ 10mA, 10V

Frequency - Transition:

40MHz

Mounting Type:

Through Hole

Supplier Device Package:

E-Line (TO-92 compatible)

Environmental & Export classification

RoHS Status:

ROHS3 Compliant

REACH Status:

REACH Unaffected

HTSUS:

8541.21.0095

Moisture Sensitivity Level (MSL):

1 (Unlimited)

ECCN:

EAR99

**ZTX415****NPN SILICON PLANAR MEDIUM POWER TRANSISTOR****Features**

- Avalanche Transistor
- 60A Peak Avalanche Current (Pulse Width = 20ns)
- $BV_{CES} > 260V$
- $BV_{CEO} > 100V$
- Specifically Designed for Avalanche Mode Operation
- **Totally Lead-Free & Fully RoHS Compliant (Notes 1 & 2)**
- **Halogen and Antimony Free. "Green" Device (Note 3)**

Mechanical Data

- Case: E-Line
- Case Material: Molded Plastic. "Green" Molding Compound. UL Flammability Rating 94V-0
- Moisture Sensitivity: Level 1 per J-STD-020
- Terminals: Finish – Matte Tin Plated Leads. Solderable per MIL-STD-202, Method 208 e3
- Weight: 159mg (Approximate)



E-Line

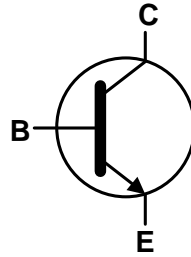

Device Symbol

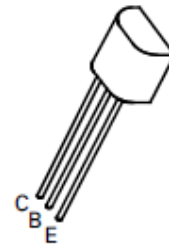
Top View
Pin-Out**Ordering Information** (Note 4)

Part Number	Compliance	Marking	Quantity
ZTX415	Standard	ZTX415	4000 Bulk
ZTX415STZ	Standard	ZTX415	2000 Taped

- Notes:
1. No purposely added lead. Fully EU Directive 2002/95/EC (RoHS), 2011/65/EU (RoHS 2) & 2015/863/EU (RoHS 3) compliant.
 2. See <https://www.diodes.com/quality/lead-free/> for more information about Diodes Incorporated's definitions of Halogen- and Antimony-free, "Green" and Lead-free.
 3. Halogen- and Antimony-free "Green" products are defined as those which contain <900ppm bromine, <900ppm chlorine (<1500ppm total Br + Cl) and <1000ppm antimony compounds.
 4. For packaging details, go to our website at <https://www.diodes.com/design/support/packaging/diodes-packaging/>.

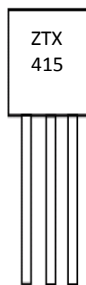
Marking Information

ZTX 415 = Product Type Marking Code



ZTX415

Absolute Maximum Ratings (@ $T_A = +25^\circ\text{C}$, unless otherwise specified.)

Characteristic	Symbol	Value	Unit
Collector-Base Voltage	V_{CBO}	260	V
Collector-Emitter Voltage	V_{CES}	260	V
Collector-Emitter Voltage	V_{CEO}	100	V
Emitter-Base Voltage	V_{EBO}	6	V
Continuous Collector Current	I_C	500	mA
Peak Collector Current (Pulse Width = 20ns)	I_{CM}	60	A

Thermal Characteristics (@ $T_A = +25^\circ\text{C}$, unless otherwise specified.)

Characteristic	Symbol	Value	Unit
Power Dissipation	P_D	680	mW
Thermal Resistance, Junction to Ambient	$R_{\theta JA}$	250	$^\circ\text{C}/\text{W}$
Thermal Resistance, Junction to Lead	$R_{\theta JL}$	197	$^\circ\text{C}/\text{W}$
Operating and Storage Temperature Range	T_J, T_{STG}	-55 to +150	$^\circ\text{C}$

ESD Ratings (Note 7)

Characteristic	Symbol	Value	Unit	JEDEC Class
Electrostatic Discharge - Human Body Model	ESD HBM	4,000	V	3A
Electrostatic Discharge - Machine Model	ESD MM	400	V	C

- Notes:
- For a device mounted with the collector lead on 15mm x 15mm 1oz copper that is on a single-sided 1.6mm FR-4 PCB; device is measured under still air conditions whilst operating in a steady-state.
 - Thermal resistance from junction to solder-point (at the end of the collector lead).
 - Refer to JEDEC specification JESD22-A114 and JESD22-A115.

Electrical Characteristics (@ $T_A = +25^\circ\text{C}$, unless otherwise specified.)

Characteristic	Symbol	Min	Typ	Max	Unit	Test Condition
Collector-Emitter Breakdown Voltage	BV_{CES}	260	—	—	V	$I_C = 1\text{mA}$ $T_J = -55$ to $+150^\circ\text{C}$
Collector-Emitter Breakdown Voltage (Note 8)	BV_{CEO}	100	—	—	V	$I_C = 100\mu\text{A}$
Emitter-Base Breakdown Voltage	BV_{EBO}	6	—	—	V	$I_E = 100\mu\text{A}$
Collector Cutoff Current	I_{CBO}	—	—	100 10	nA μA	$V_{CB} = 180\text{V}$ $V_{CB} = 180\text{V}, T_J = +100^\circ\text{C}$
Emitter Cutoff Current	I_{EBO}	—	—	100	nA	$V_{EB} = 4\text{V}$
Static Forward Current Transfer Ratio (Note 8)	h_{FE}	25	—	—	—	$I_C = 10\text{mA}, V_{CE} = 10\text{V}$
Collector-Emitter Saturation Voltage (Note 8)	$V_{CE(sat)}$	—	—	500	mV	$I_C = 10\text{mA}, I_B = 1\text{mA}$
Base-Emitter Saturation Voltage (Note 8)	$V_{BE(sat)}$	—	—	900	mV	$I_C = 10\text{mA}, I_B = 1\text{mA}$
Pulsed Current in Second Breakdown	I_{USB}	—	25 35	—	A	$V_C = 200\text{V}, C_{CE} = 620\text{pF}$ $V_C = 250\text{V}, C_{CE} = 620\text{pF}$
Collector-Emitter inductance	L_{ce}	—	2.5	—	nH	Standard SOT23 Leads
Output Capacitance	C_{obo}	—	—	8	pF	$V_{CB} = 20\text{V}, I_E = 0$ $f = 100\text{MHz}$
Transition Frequency	f_T	40	—	—	MHz	$V_{CE} = 20\text{V}, I_C = 10\text{mA},$ $f = 20\text{MHz}$

- Note: 8. Measured under pulsed conditions. Pulse width $\leq 300\mu\text{s}$. Duty cycle $\leq 2\%$.



ZTX415

Typical Electrical Characteristics (@T_A = +25°C, unless otherwise specified.)

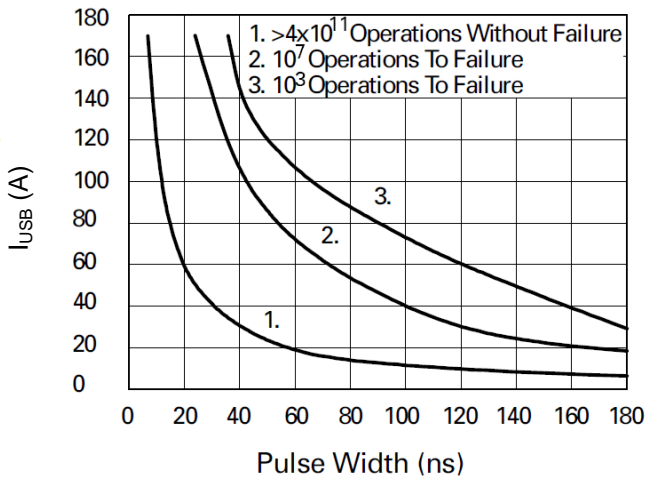

Maximum Avalanche Current v Pulse Width

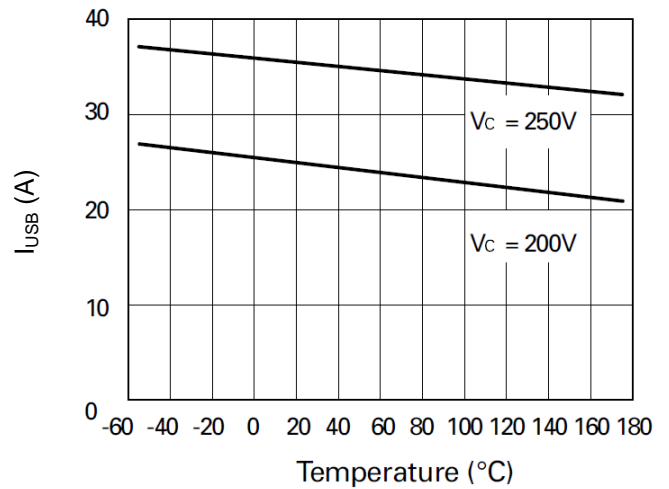

I_{USB} v Temperature for the specified conditions

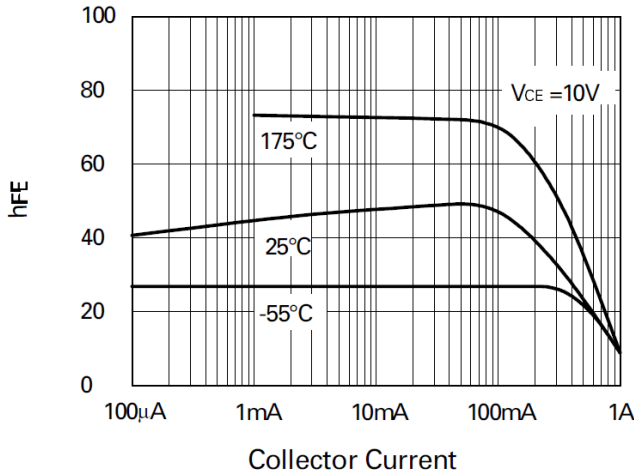

hFE v I_C

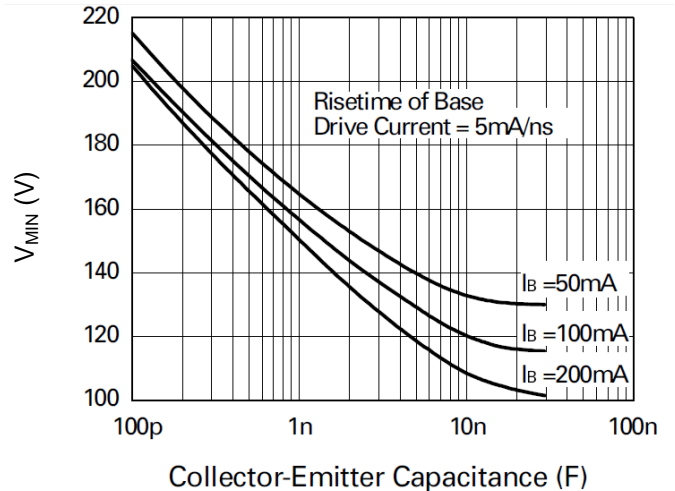

Minimum starting voltage as a function of capacitance

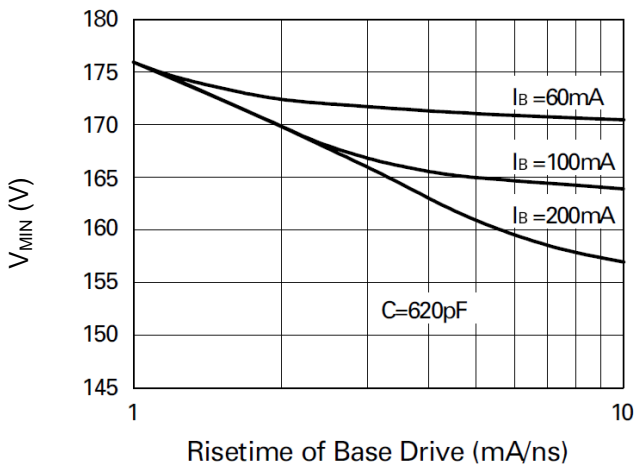

Minimum starting voltage as a function of drive current

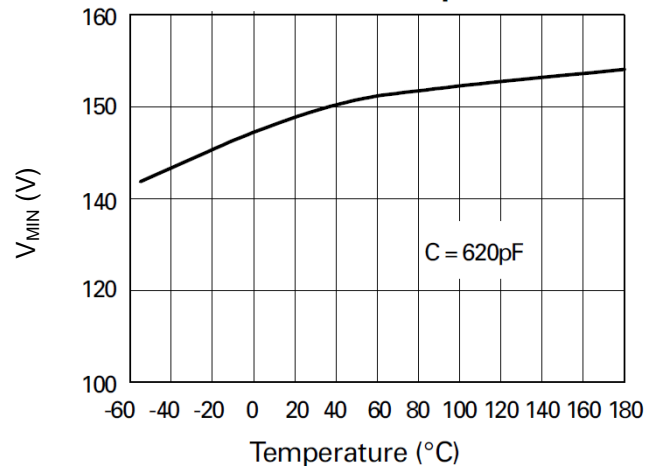

Minimum starting voltage as a function of temperature



ZTX415

Package Outline Dimensions

Please see <http://www.diodes.com/package-outlines.html> for the latest version.

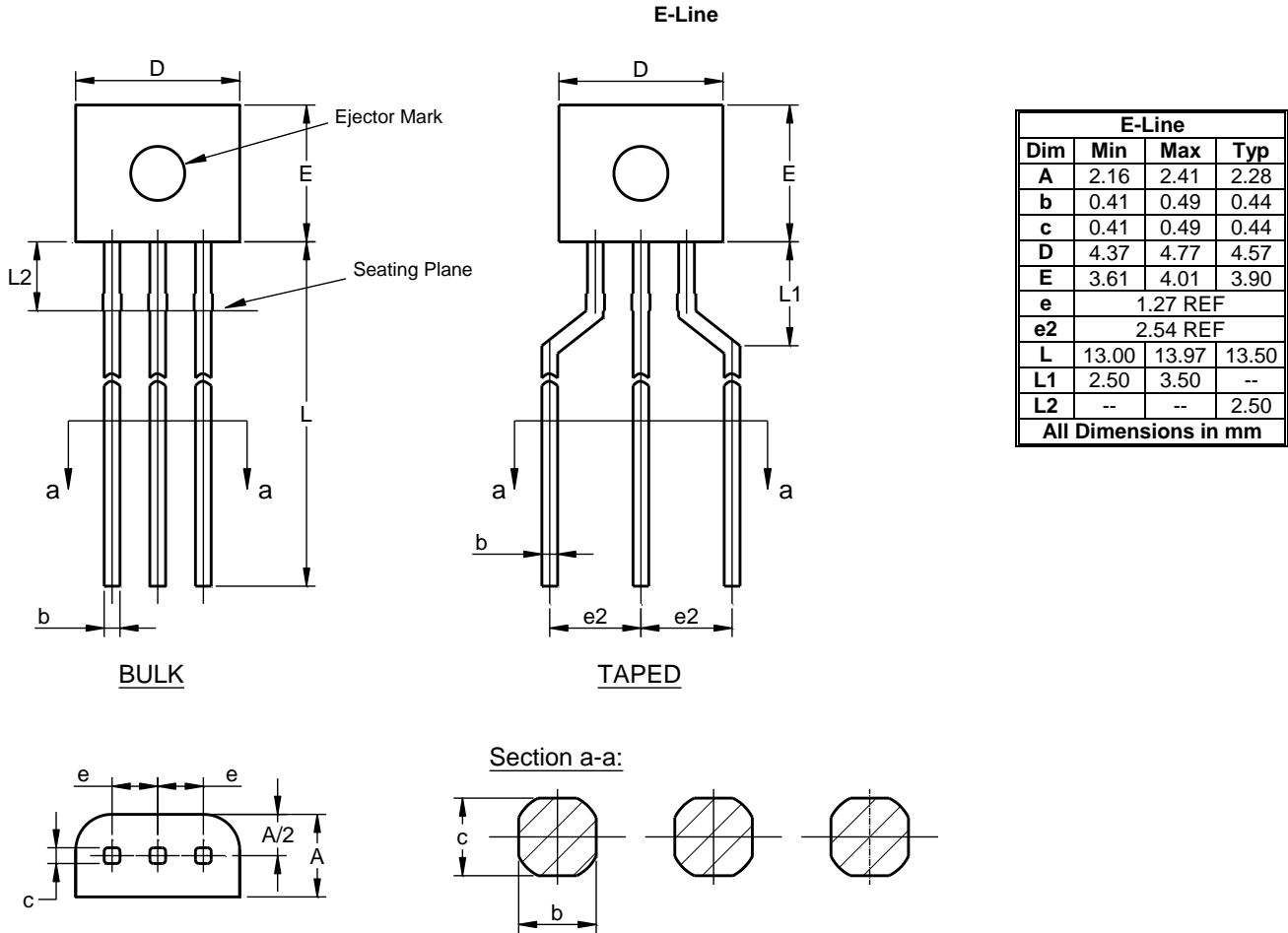

Suggested Pad Hole

Please see <http://www.diodes.com/package-outlines.html> for the latest version.

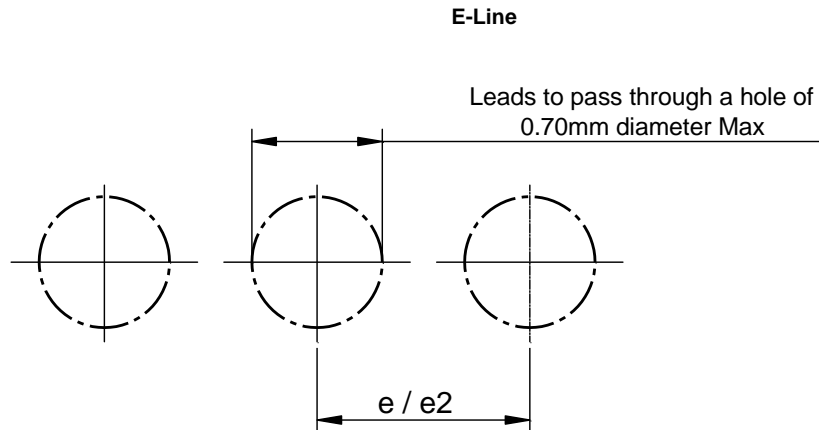



IMPORTANT NOTICE

DIODES INCORPORATED MAKES NO WARRANTY OF ANY KIND, EXPRESS OR IMPLIED, WITH REGARDS TO THIS DOCUMENT, INCLUDING, BUT NOT LIMITED TO, THE IMPLIED WARRANTIES OF MERCHANTABILITY AND FITNESS FOR A PARTICULAR PURPOSE (AND THEIR EQUIVALENTS UNDER THE LAWS OF ANY JURISDICTION).

Diodes Incorporated and its subsidiaries reserve the right to make modifications, enhancements, improvements, corrections or other changes without further notice to this document and any product described herein. Diodes Incorporated does not assume any liability arising out of the application or use of this document or any product described herein; neither does Diodes Incorporated convey any license under its patent or trademark rights, nor the rights of others. Any Customer or user of this document or products described herein in such applications shall assume all risks of such use and will agree to hold Diodes Incorporated and all the companies whose products are represented on Diodes Incorporated website, harmless against all damages.

Diodes Incorporated does not warrant or accept any liability whatsoever in respect of any products purchased through unauthorized sales channel. Should Customers purchase or use Diodes Incorporated products for any unintended or unauthorized application, Customers shall indemnify and hold Diodes Incorporated and its representatives harmless against all claims, damages, expenses, and attorney fees arising out of, directly or indirectly, any claim of personal injury or death associated with such unintended or unauthorized application.

Products described herein may be covered by one or more United States, international or foreign patents pending. Product names and markings noted herein may also be covered by one or more United States, international or foreign trademarks.

This document is written in English but may be translated into multiple languages for reference. Only the English version of this document is the final and determinative format released by Diodes Incorporated.

LIFE SUPPORT

Diodes Incorporated products are specifically not authorized for use as critical components in life support devices or systems without the express written approval of the Chief Executive Officer of Diodes Incorporated. As used herein:

A. Life support devices or systems are devices or systems which:

1. are intended to implant into the body, or
2. support or sustain life and whose failure to perform when properly used in accordance with instructions for use provided in the labeling can be reasonably expected to result in significant injury to the user.

B. A critical component is any component in a life support device or system whose failure to perform can be reasonably expected to cause the failure of the life support device or to affect its safety or effectiveness.

Customers represent that they have all necessary expertise in the safety and regulatory ramifications of their life support devices or systems, and acknowledge and agree that they are solely responsible for all legal, regulatory and safety-related requirements concerning their products and any use of Diodes Incorporated products in such safety-critical, life support devices or systems, notwithstanding any devices- or systems-related information or support that may be provided by Diodes Incorporated. Further, Customers must fully indemnify Diodes Incorporated and its representatives against any damages arising out of the use of Diodes Incorporated products in such safety-critical, life support devices or systems.

Copyright © 2018, Diodes Incorporated

www.diodes.com

OUR CERTIFICATE

DiGi provide top-quality products and perfect service for customer worldwide through standardization, technological innovation and continuous improvement. DiGi through third-party certification, we stricly control the quality of products and services. Welcome your RFQ to

Email: Info@DiGi-Electronics.com



Tel: +00 852-30501935

RFQ Email: Info@DiGi-Electronics.com

DiGi is a global authorized distributor of electronic components.