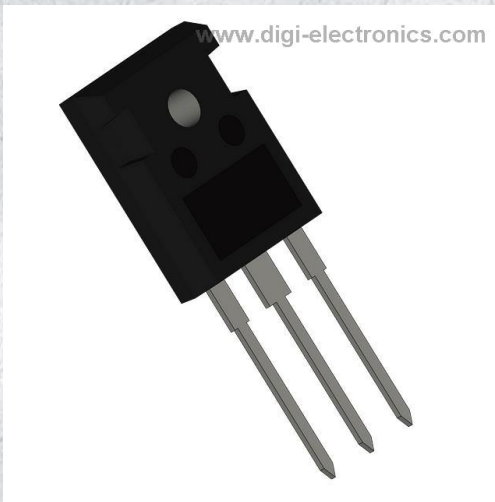


# AUIRFP4110 Datasheet



<https://www.DiGi-Electronics.com>

DiGi Electronics Part Number	AUIRFP4110-DG
Manufacturer	<a href="#">International Rectifier</a>
Manufacturer Product Number	AUIRFP4110
Description	MOSFET N-CH 100V 120A TO247AC
Detailed Description	N-Channel 100 V 120A (Tc) 370W (Tc) Through Hole TO-247AC



Tel: +00 852-30501935

RFQ Email: [Info@DiGi-Electronics.com](mailto:Info@DiGi-Electronics.com)

DiGi is a global authorized distributor of electronic components.

## Purchase and inquiry

Manufacturer Product Number:

AUIRFP4110

Series:

HEXFET®

FET Type:

N-Channel

Drain to Source Voltage (Vdss):

100 V

Drive Voltage (Max Rds On, Min Rds On):

10V

Vgs(th) (Max) @ Id:

4V @ 250µA

Vgs (Max):

±20V

FET Feature:

-

Operating Temperature:

-55°C ~ 175°C (Tj)

Supplier Device Package:

TO-247AC

Manufacturer:

International Rectifier

Product Status:

Active

Technology:

MOSFET (Metal Oxide)

Current - Continuous Drain (Id) @ 25°C:

120A (Tc)

Rds On (Max) @ Id, Vgs:

4.5mOhm @ 75A, 10V

Gate Charge (Qg) (Max) @ Vgs:

210 nC @ 10 V

Input Capacitance (Ciss) (Max) @ Vds:

9620 pF @ 50 V

Power Dissipation (Max):

370W (Tc)

Mounting Type:

Through Hole

Package / Case:

TO-247-3

## Environmental & Export classification

ECCN:

EAR99

HTSUS:

8541.29.0095



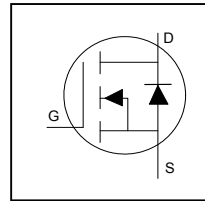
**Features**

- Advanced Process Technology
- Ultra Low On-Resistance
- Enhanced  $dV/dT$  and  $dI/dT$  capability
- 175°C Operating Temperature
- Fast Switching
- Repetitive Avalanche Allowed up to  $T_{jmax}$
- Lead-Free, RoHS Compliant
- Automotive Qualified \*

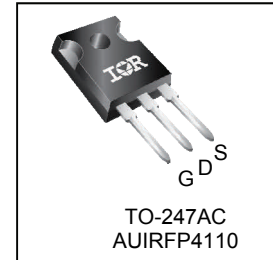
**Description**

Specifically designed for Automotive applications, this HEXFET® Power MOSFETs utilizes the latest processing techniques to achieve low on-resistance per silicon area. Additional features of this design are a 175°C junction operating temperature, fast switching speed and improved repetitive avalanche rating. These features combine to make this design an extremely efficient and reliable device for use in Automotive applications and a wide variety of other applications.

## HEXFET® Power MOSFET



$V_{DSS}$	<b>100V</b>
$R_{DS(on)}$ typ.	<b>3.7mΩ</b>
	max
$I_D$ (Silicon Limited)	<b>180A①</b>
$I_D$ (Package Limited)	<b>120A</b>



<b>G</b>	<b>D</b>	<b>S</b>
Gate	Drain	Source

Base part number	Package Type	Standard Pack		Orderable Part Number
		Form	Quantity	
AUIRFP4110	TO-247AC	Tube	25	AUIRFP4110

**Absolute Maximum Ratings**

Stresses beyond those listed under "Absolute Maximum Ratings" may cause permanent damage to the device. These are stress ratings only; and functional operation of the device at these or any other condition beyond those indicated in the specifications is not implied. Exposure to absolute-maximum-rated conditions for extended periods may affect device reliability. The thermal resistance and power dissipation ratings are measured under board mounted and still air conditions. Ambient temperature ( $T_A$ ) is 25°C, unless otherwise specified.

	Parameter	Max.	Units
$I_D @ T_C = 25^\circ\text{C}$	Continuous Drain Current, $V_{GS} @ 10\text{V}$ (Silicon Limited)	180①	A
$I_D @ T_C = 100^\circ\text{C}$	Continuous Drain Current, $V_{GS} @ 10\text{V}$ (Silicon Limited)	130①	
$I_D @ T_C = 25^\circ\text{C}$	Continuous Drain Current, $V_{GS} @ 10\text{V}$ (Package Limited)	120	
$I_{DM}$	Pulsed Drain Current ②	670	
$P_D @ T_C = 25^\circ\text{C}$	Maximum Power Dissipation	370	W
	Linear Derating Factor	2.5	W/°C
$V_{GS}$	Gate-to-Source Voltage	± 20	V
$E_{AS}$ (Thermally limited)	Single Pulse Avalanche Energy ③	190	mJ
$I_{AR}$	Avalanche Current ②	108	A
$E_{AR}$	Repetitive Avalanche Energy ⑤	37	mJ
$dv/dt$	Peak Diode Recovery ④	5.3	V/ns
$T_J$ $T_{STG}$	Operating Junction and Storage Temperature Range	-55 to + 175	°C
	Soldering Temperature, for 10 seconds (1.6mm from case)	300	
	Mounting Torque, 6-32 or M3 Screw	10 lbf·in (1.1 N·m)	

**Thermal Resistance**

	Parameter	Typ.	Max.	Units
$R_{\theta JC}$	Junction-to-Case ⑧	—	0.402	°C/W
$R_{\theta CS}$	Case-to-Sink, Flat Greased Surface	0.24	—	
$R_{\theta JA}$	Junction-to-Ambient	—	40	

HEXFET® is a registered trademark of Infineon.

\*Qualification standards can be found at [www.infineon.com](http://www.infineon.com)


**Static @  $T_J = 25^\circ\text{C}$  (unless otherwise specified)**

	Parameter	Min.	Typ.	Max.	Units	Conditions
$V_{(BR)DSS}$	Drain-to-Source Breakdown Voltage	100	—	—	V	$V_{GS} = 0V, I_D = 250\mu A$
$\Delta V_{(BR)DSS}/\Delta T_J$	Breakdown Voltage Temp. Coefficient	—	0.108	—	V/ $^\circ\text{C}$	Reference to $25^\circ\text{C}, I_D = 5mA$
$R_{DS(on)}$	Static Drain-to-Source On-Resistance	—	3.7	4.5	m $\Omega$	$V_{GS} = 10V, I_D = 75A$ ⑤
$V_{GS(th)}$	Gate Threshold Voltage	2.0	—	4.0	V	$V_{DS} = V_{GS}, I_D = 250\mu A$
gfs	Forward Trans conductance	160	—	—	S	$V_{DS} = 50V, I_D = 75A$
$I_{DSS}$	Drain-to-Source Leakage Current	—	—	20	$\mu A$	$V_{DS} = 100V, V_{GS} = 0V$
		—	—	250		$V_{DS} = 100V, V_{GS} = 0V, T_J = 125^\circ\text{C}$
$I_{GSS}$	Gate-to-Source Forward Leakage	—	—	100	nA	$V_{GS} = 20V$
	Gate-to-Source Reverse Leakage	—	—	-100		$V_{GS} = -20V$
$R_G$	Gate Resistance	—	1.3	—	$\Omega$	

**Dynamic Electrical Characteristics @  $T_J = 25^\circ\text{C}$  (unless otherwise specified)**

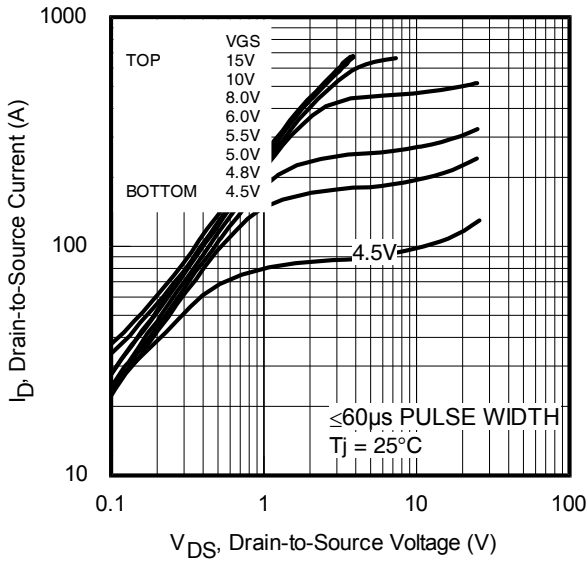
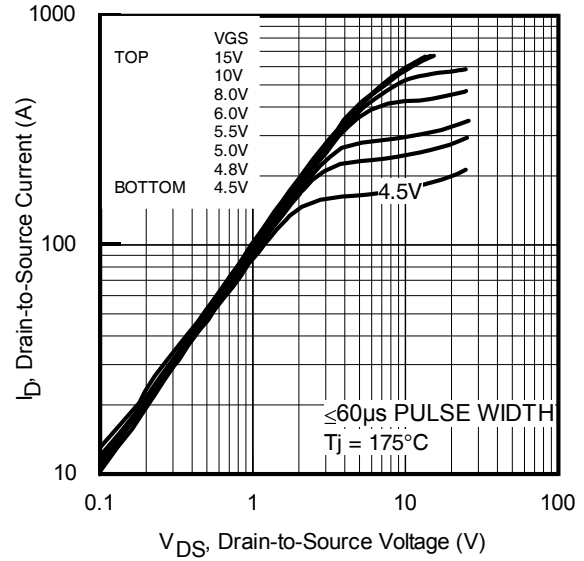
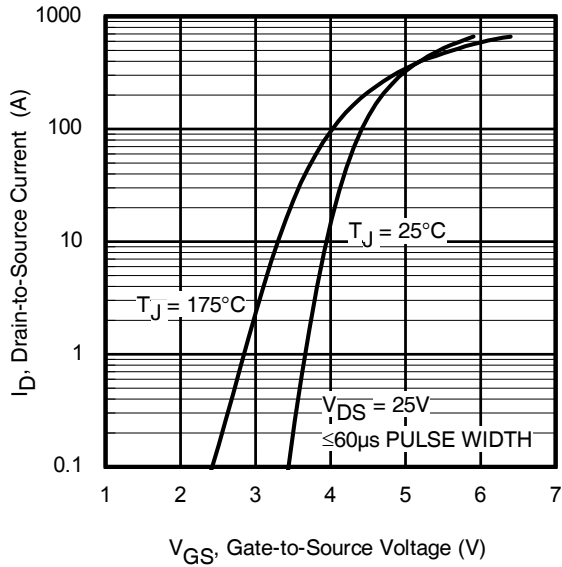
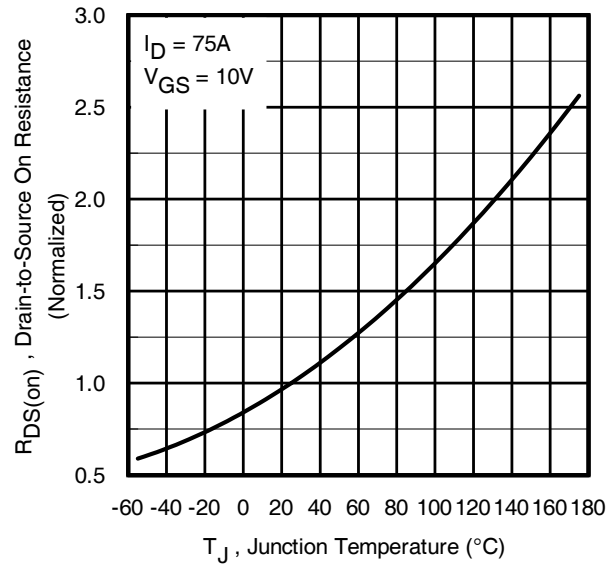
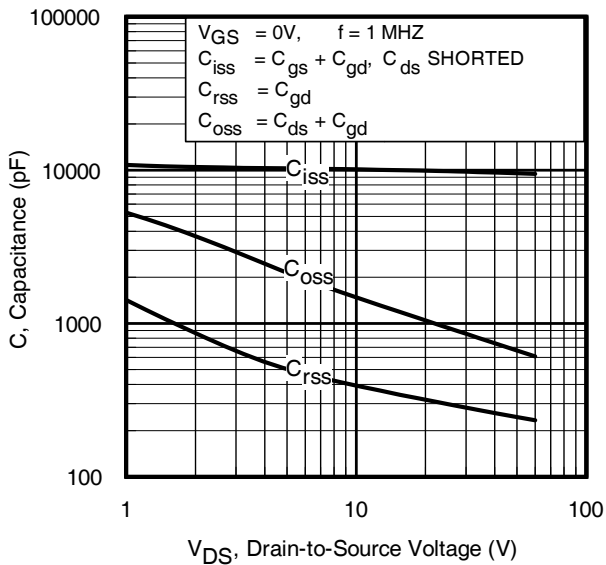
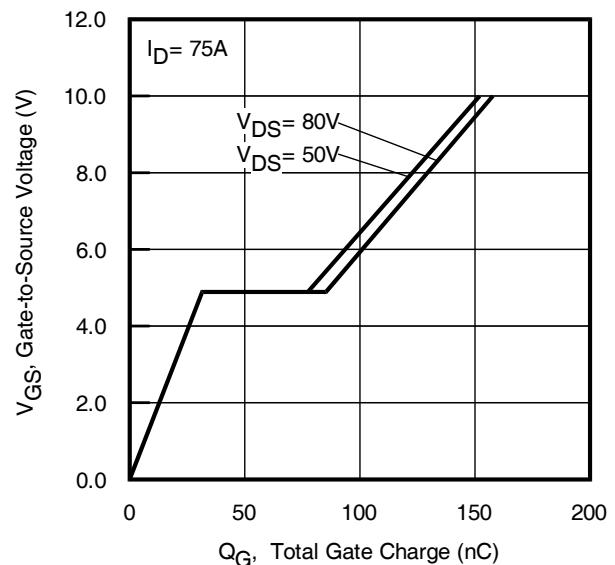
$Q_g$	Total Gate Charge	—	150	210	nC	$I_D = 75A$
$Q_{gs}$	Gate-to-Source Charge	—	35	—		$V_{DS} = 50V$
$Q_{gd}$	Gate-to-Drain Charge	—	43	—		$V_{GS} = 10V$ ⑤
$t_{d(on)}$	Turn-On Delay Time	—	25	—	ns	$V_{DD} = 65V$
$t_r$	Rise Time	—	67	—		$I_D = 75A$
$t_{d(off)}$	Turn-Off Delay Time	—	78	—		$R_G = 2.6\Omega$
$t_f$	Fall Time	—	88	—		$V_{GS} = 10V$ ⑤
$C_{iss}$	Input Capacitance	—	9620	—	pF	$V_{GS} = 0V$
$C_{oss}$	Output Capacitance	—	670	—		$V_{DS} = 50V$
$C_{rss}$	Reverse Transfer Capacitance	—	250	—		$f = 1.0MHz$
$C_{oss\ eff.(ER)}$	Effective Output Capacitance (Energy Related)	—	820	—		$V_{GS} = 0V, V_{DS} = 0V$ to 80V ⑦
$C_{oss\ eff.(TR)}$	Output Capacitance (Time Related)	—	950	—		$V_{GS} = 0V, V_{DS} = 0V$ to 80V ⑧

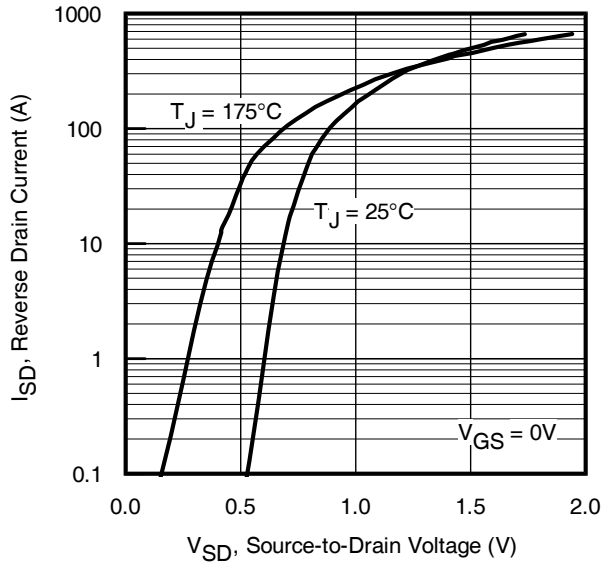
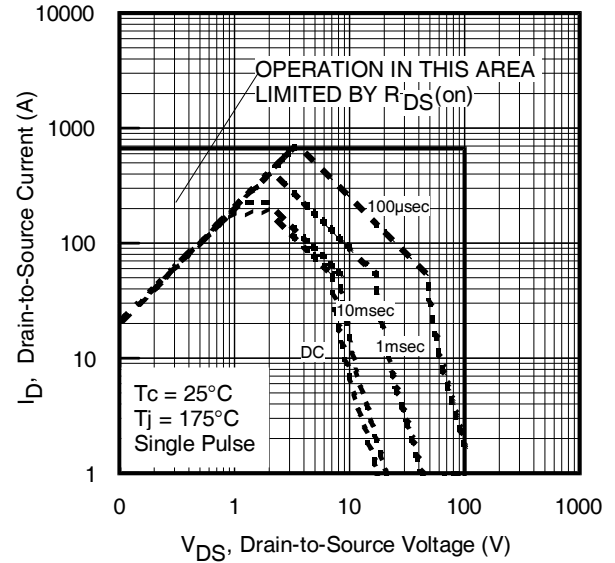
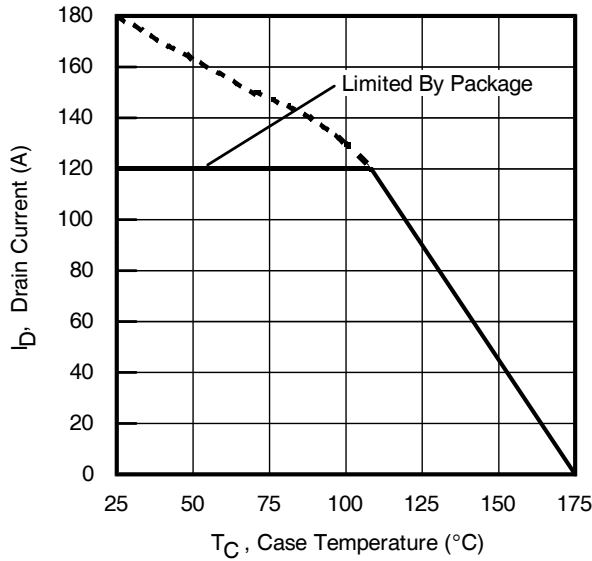
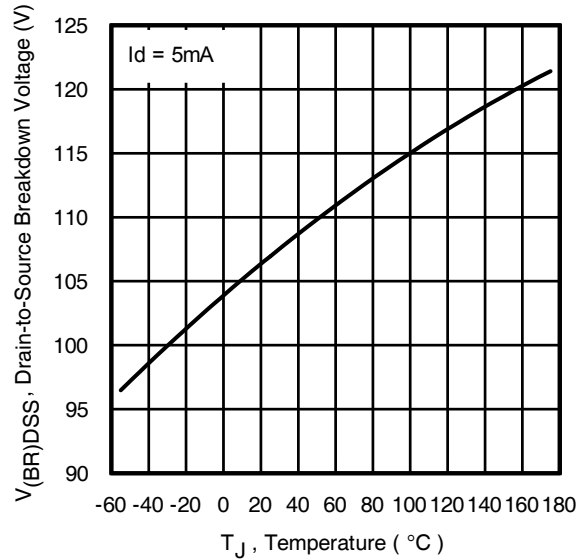
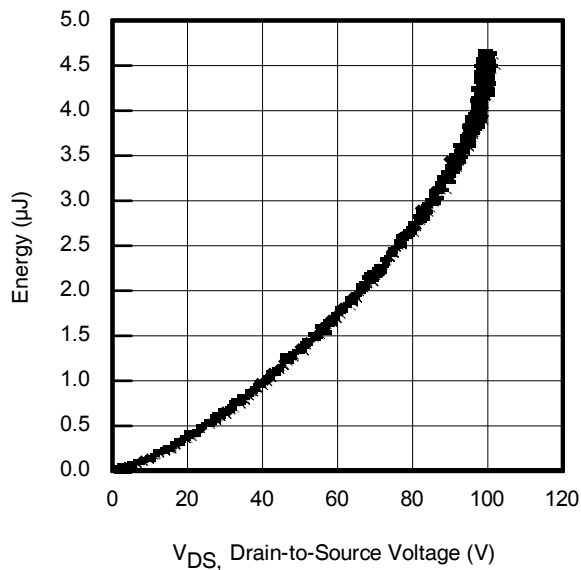
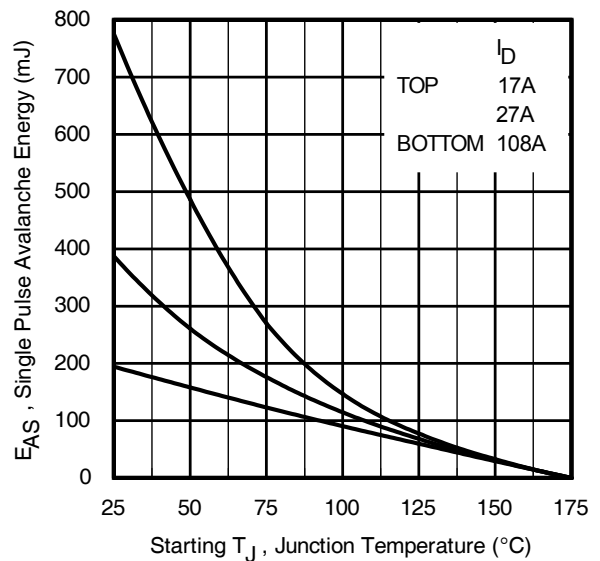
**Diode Characteristics**

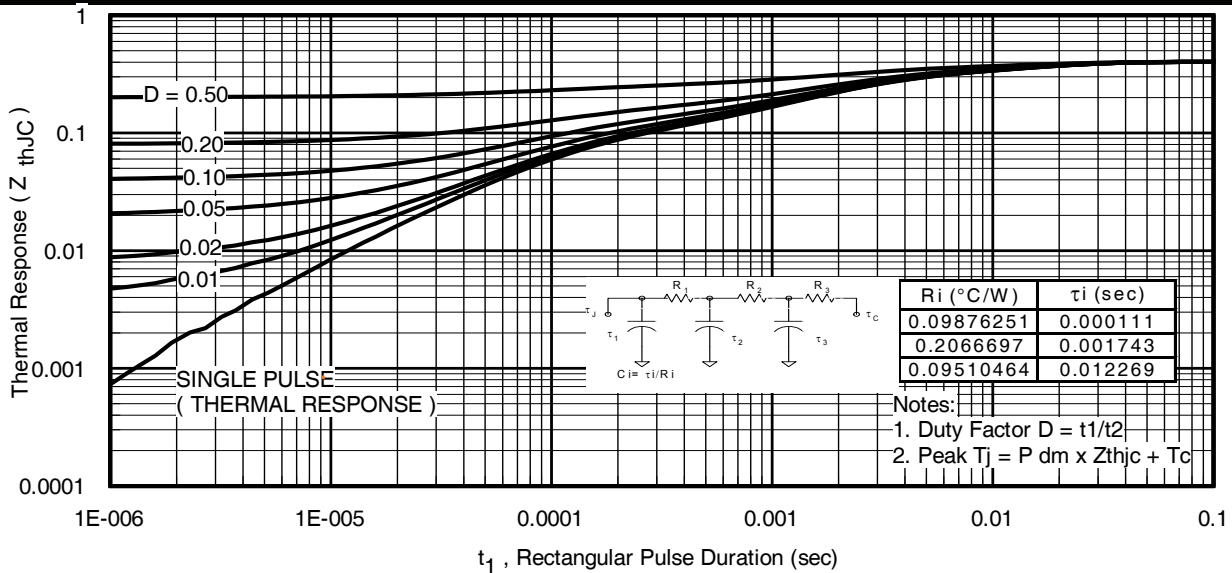
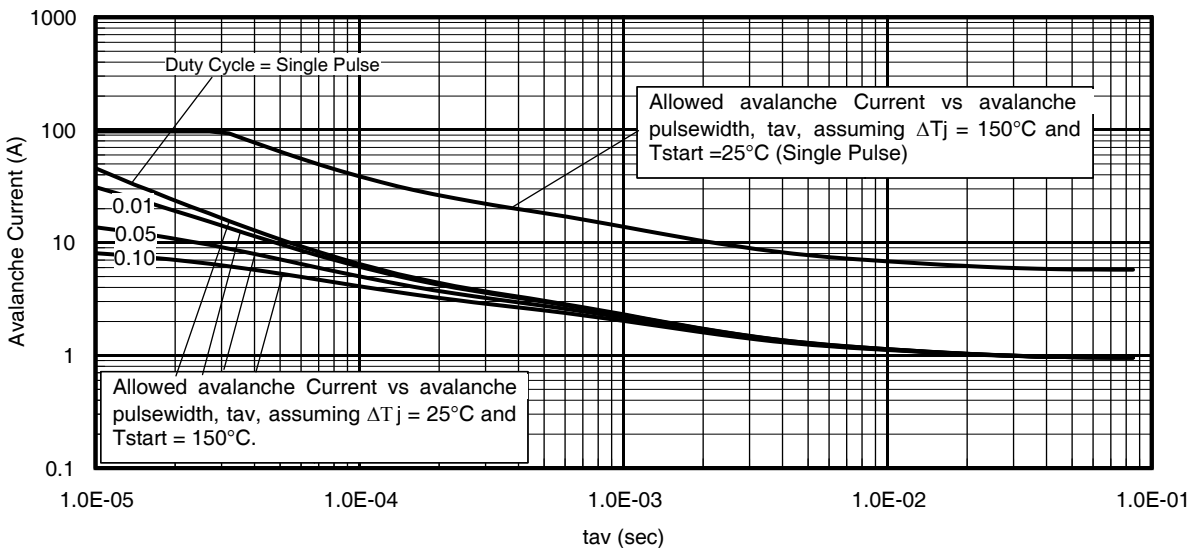
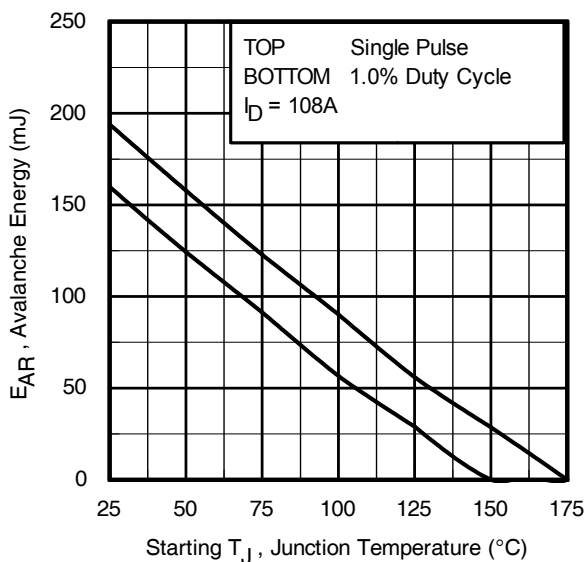
	Parameter	Min.	Typ.	Max.	Units	Conditions
$I_S$	Continuous Source Current (Body Diode)	—	—	180 ①	A	MOSFET symbol showing the integral reverse p-n junction diode. 
$I_{SM}$	Pulsed Source Current (Body Diode) ②	—	—	670		
$V_{SD}$	Diode Forward Voltage	—	—	1.3	V	$T_J = 25^\circ\text{C}, I_S = 75A, V_{GS} = 0V$ ⑤
$t_{rr}$	Reverse Recovery Time	—	50	75	ns	$T_J = 25^\circ\text{C}$ $V_{DD} = 85V$
		—	60	90		$T_J = 125^\circ\text{C}$ $I_F = 75A,$
$Q_{rr}$	Reverse Recovery Charge	—	94	140	nC	$T_J = 25^\circ\text{C}$ $di/dt = 100A/\mu s$ ⑤
		—	140	210		$T_J = 125^\circ\text{C}$
$I_{RRM}$	Reverse Recovery Current	—	3.5	—	A	$T_J = 25^\circ\text{C}$

**Notes:**

- ① Calculated continuous current based on maximum allowable junction temperature. Bond wire current limit is 120A. Note that current limitations arising from heating of the device leads may occur with some lead mounting arrangements.
- ② Repetitive rating; pulse width limited by max. junction temperature.
- ③ Limited by  $T_{Jmax}$ , starting  $T_J = 25^\circ\text{C}$ ,  $L = 0.033mH$ ,  $R_G = 25\Omega$ ,  $I_{AS} = 108A$ ,  $V_{GS} = 10V$ . Part not recommended for use above this value.
- ④  $I_{SD} \leq 75A$ ,  $di/dt \leq 630A/\mu s$ ,  $V_{DD} \leq V_{(BR)DSS}$ ,  $T_J \leq 175^\circ\text{C}$ .
- ⑤ Pulse width  $\leq 400\mu s$ ; duty cycle  $\leq 2\%$ .
- ⑥  $C_{oss\ eff. (TR)}$  is a fixed capacitance that gives the same charging time as  $C_{oss}$  while  $V_{DS}$  is rising from 0 to 80%  $V_{DSS}$ .
- ⑦  $C_{oss\ eff. (ER)}$  is a fixed capacitance that gives the same energy as  $C_{oss}$  while  $V_{DS}$  is rising from 0 to 80%  $V_{DSS}$ .
- ⑧  $R_\theta$  is measured at  $T_J$  approximately  $90^\circ\text{C}$ .


**Fig 1.** Typical Output Characteristics

**Fig 2.** Typical Output Characteristics

**Fig 3.** Typical Transfer Characteristics

**Fig 4.** Normalized On-Resistance vs. Temperature

**Fig 5.** Typical Capacitance vs. Drain-to-Source Voltage

**Fig 6.** Typical Gate Charge vs. Gate-to-Source Voltage


**Fig 7.** Typical Source-Drain Diode Forward Voltage

**Fig 8.** Maximum Safe Operating Area

**Fig 9.** Maximum Drain Current vs. Case Temperature

**Fig 10.** Drain-to-Source Breakdown Voltage

**Fig 11.** Typical  $C_{oss}$  Stored Energy

**Fig 12.** Threshold Voltage vs. Temperature


**Fig 13. Maximum Effective Transient Thermal Impedance, Junction-to-Case**

**Fig 14. Avalanche Current vs. Pulse width**

**Notes on Repetitive Avalanche Curves, Figures 14, 15:**  
**(For further info, see AN-1005 at www.irf.com)**

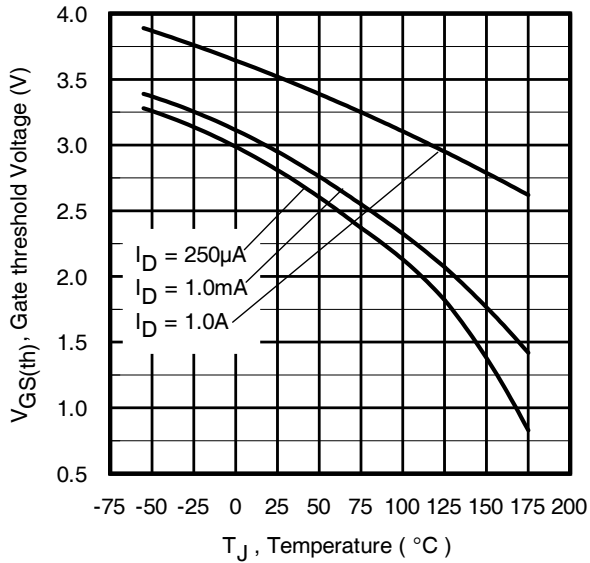
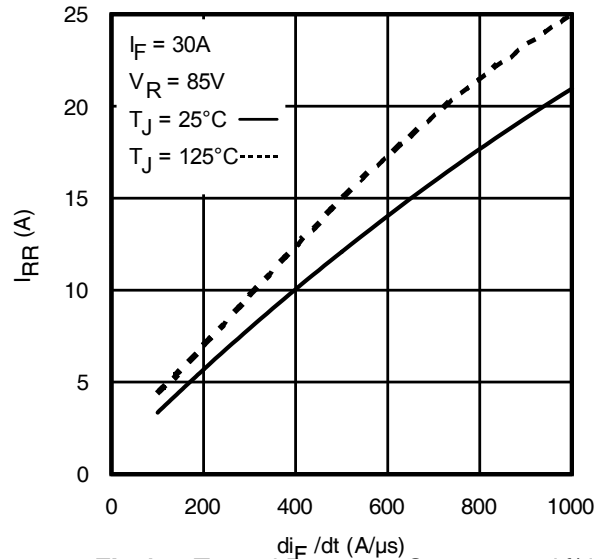
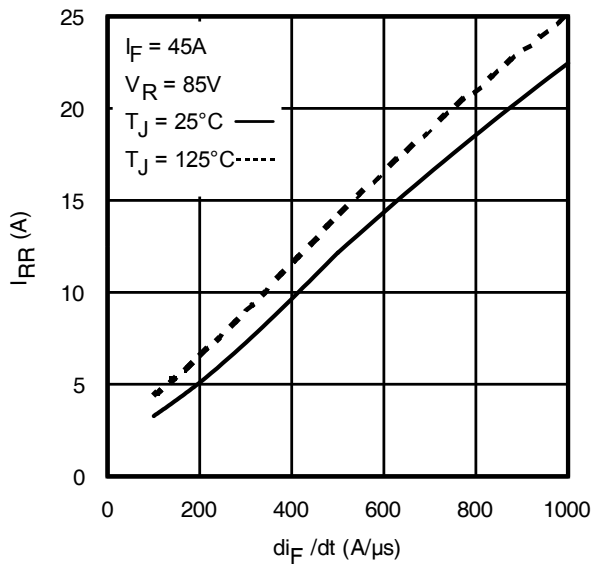
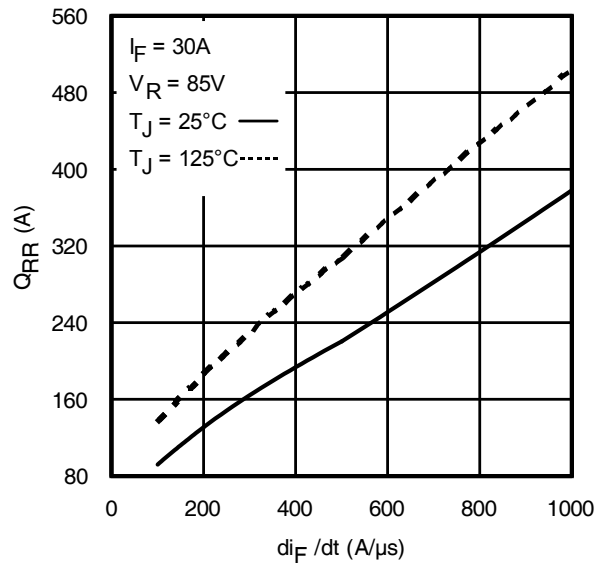
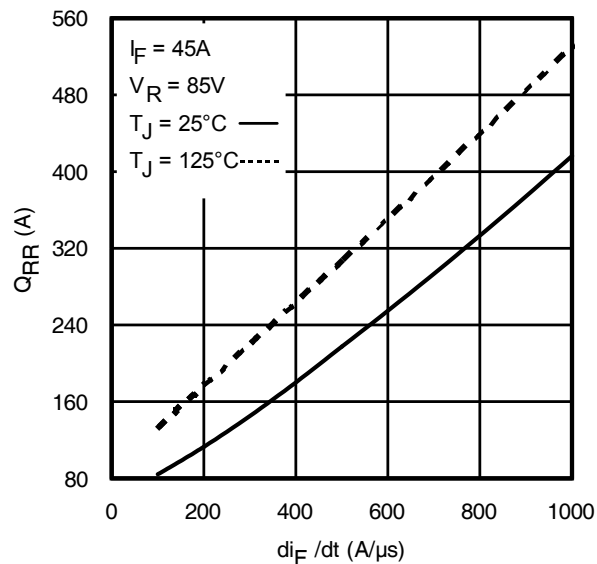
- Avalanche failures assumption:  
Purely a thermal phenomenon and failure occurs at a temperature far in excess of  $T_{jmax}$ . This is validated for every part type.
- Safe operation in Avalanche is allowed as long as  $T_{jmax}$  is not exceeded.
- Equation below based on circuit and waveforms shown in Figures 22a, 22b.
- $P_D$  (ave) = Average power dissipation per single avalanche pulse.
- BV = Rated breakdown voltage (1.3 factor accounts for voltage increase during avalanche).
- $I_{av}$  = Allowable avalanche current.
- $\Delta T$  = Allowable rise in junction temperature, not exceed  $T_{jmax}$  (assumed as  $25^{\circ}C$  in figure 14, 15).  
 $t_{av}$  = Average time in avalanche.  
 $D$  = Duty cycle in avalanche =  $t_{av} \cdot f$   
 $Z_{thJC}(D, t_{av})$  = Transient thermal resistance, see Figures 13)

$$P_D(ave) = 1/2 (1.3 \cdot BV \cdot I_{av}) = \Delta T / Z_{thJC}$$

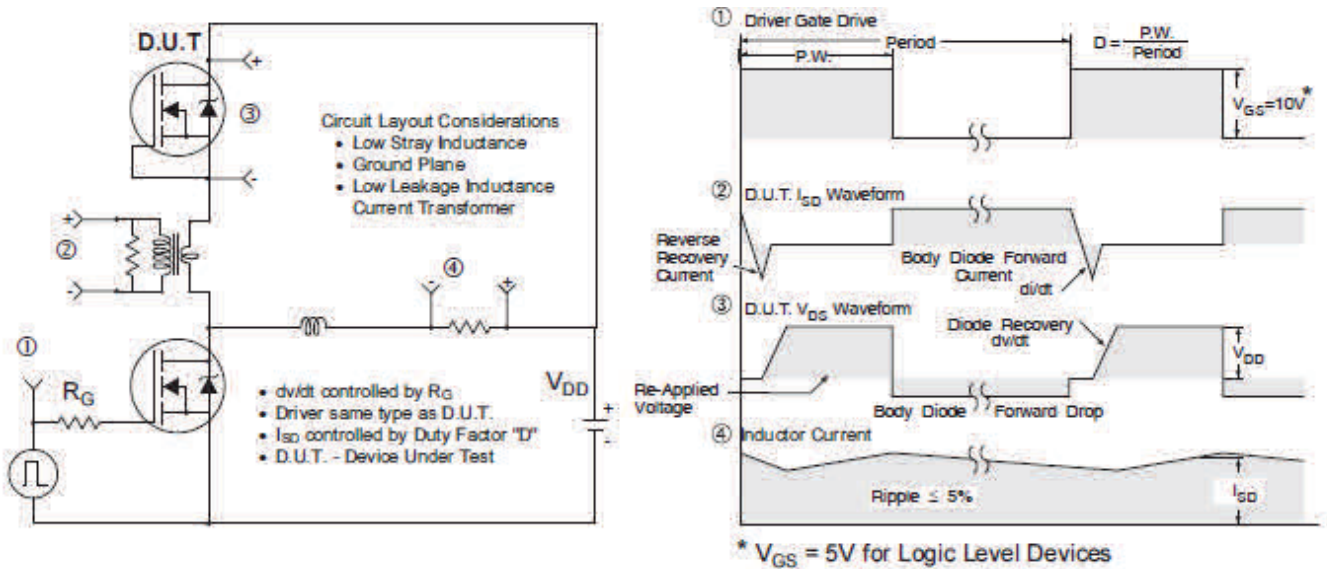
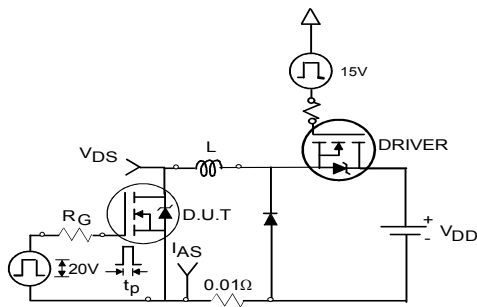
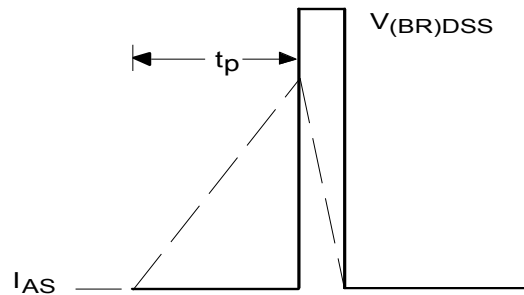
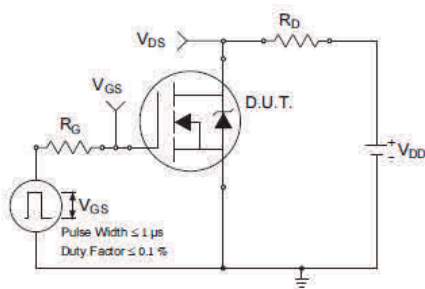
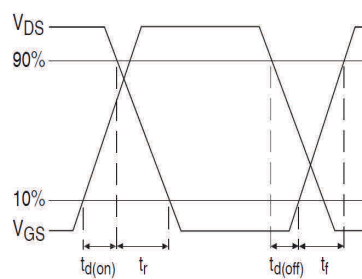
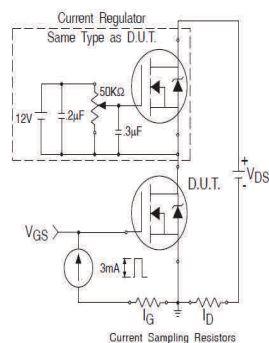
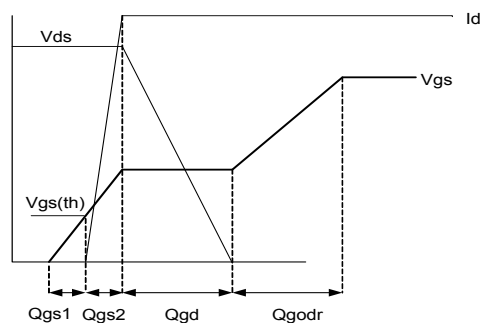
$$I_{av} = 2\Delta T / [1.3 \cdot BV \cdot Z_{th}]$$

$$E_{AS(AR)} = P_D(ave) \cdot t_{av}$$

**Fig 15. Maximum Avalanche Energy vs. Temperature**

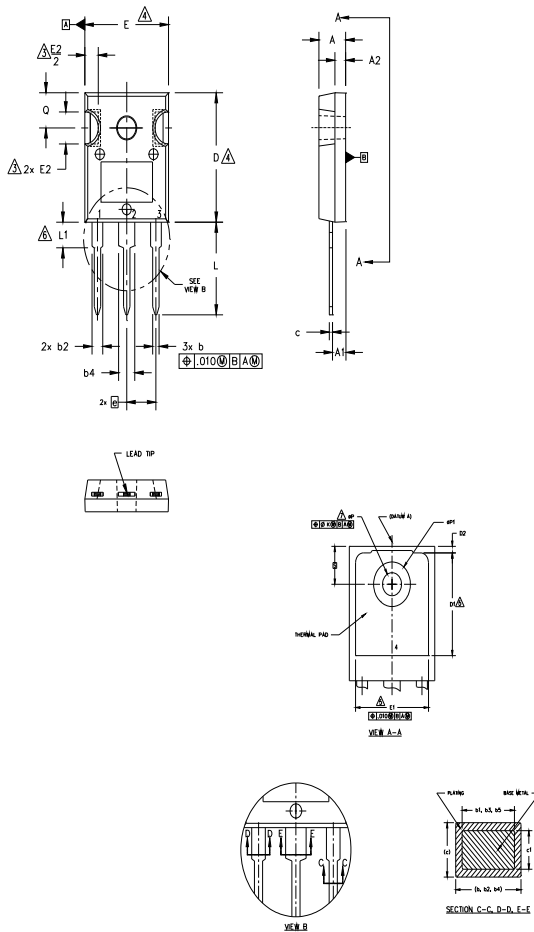

**Fig 16.** Threshold Voltage vs. Temperature

**Fig 17.** Typical Recovery Current vs.  $di_F/dt$ 

**Fig 18.** Typical Recovery Current vs.  $di_F/dt$ 

**Fig 19.** Typical Stored Charge vs.  $di_F/dt$ 

**Fig 20.** Typical Stored Charge vs.  $di_F/dt$




**Fig 21. Peak Diode Recovery  $dv/dt$  Test Circuit for N-Channel HEXFET<sup>®</sup> Power MOSFETs**

**Fig 22a. Unclamped Inductive Test Circuit**

**Fig 22b. Unclamped Inductive Waveforms**

**Fig 23a. Switching Time Test Circuit**

**Fig 23b. Switching Time Waveforms**

**Fig 24a. Gate Charge Test Circuit**

**Fig 24b. Gate Charge Waveform**

## TO-247AC Package Outline

Dimensions are shown in millimeters (inches)

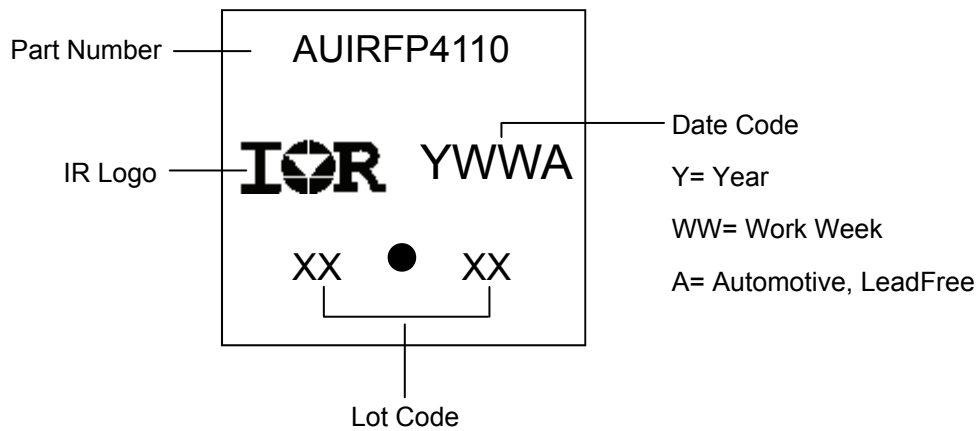


- NOTES:
1. DIMENSIONING AND TOLERANCING AS PER ASME Y14.5M 1994.
  2. DIMENSIONS ARE SHOWN IN INCHES.
  3. CONTOUR OF SLOT OPTIONAL.
  4. DIMENSION D & E DO NOT INCLUDE MOLD FLASH. MOLD FLASH SHALL NOT EXCEED .005" (0.127) PER SIDE. THESE DIMENSIONS ARE MEASURED AT THE OUTERMOST EXTREMES OF THE PLASTIC BODY.
  5. THERMAL PAD CONTOUR OPTIONAL WITHIN DIMENSIONS D1 & E1.
  6. LEAD FINISH UNCONTROLLED IN L1.
  7. ØP TO HAVE A MAXIMUM DRAFT ANGLE OF 1.5 ° TO THE TOP OF THE PART WITH A MAXIMUM HOLE DIAMETER OF .154 INCH.
  8. OUTLINE CONFORMS TO JEDEC OUTLINE TO-247AC .

SYMBOL	DIMENSIONS				NOTES
	INCHES		MILLIMETERS		
	MIN.	MAX.	MIN.	MAX.	
A	.183	.209	4.65	5.31	
A1	.087	.102	2.21	2.59	
A2	.059	.098	1.50	2.49	
b	.039	.065	0.99	1.40	
b1	.039	.053	0.99	1.35	
b2	.065	.094	1.65	2.39	
b3	.065	.092	1.65	2.34	
b4	.102	.135	2.59	3.43	
b5	.102	.133	2.59	3.38	
c	.015	.035	0.38	0.89	
c1	.015	.033	0.38	0.84	
D	.776	.815	19.71	20.70	4
D1	.515	-	13.08	-	5
D2	.020	.053	0.51	1.35	
E	.602	.625	15.29	15.87	4
E1	.530	-	13.46	-	
E2	.178	.216	4.52	5.49	
e	.215 BSC		5.46 BSC		
Øk	.010		0.25		
L	.559	.634	14.20	16.10	
L1	.146	.169	3.71	4.29	
ØP	.140	.144	3.56	3.66	
ØP1	-	.291	-	7.39	
Q	.209	.224	5.31	5.69	
S	.217 BSC		5.51 BSC		

- LEAD ASSIGNMENTS
- HEXFET
- 1- GATE
  - 2- DRAIN
  - 3- SOURCE
  - 4- DRAIN
- IGBTs, CoPACK
- 1- GATE
  - 2- COLLECTOR
  - 3- EMITTER
  - 4- COLLECTOR
- DIODES
- 1- ANODE/OPEN
  - 2- CATHODE
  - 3- ANODE

## TO-247AC Part Marking Information



TO-247AC package is not recommended for Surface Mount Application.

**Qualification Information**

<b>Qualification Level</b>		Automotive (per AEC-Q101)	
		Comments: This part number(s) passed Automotive qualification. Infineon's Industrial and Consumer qualification level is granted by extension of the higher Automotive level.	
<b>Moisture Sensitivity Level</b>		TO-247AC	N/A
<b>ESD</b>	Machine Model	Class M4 (+/- 800) <sup>†</sup> AEC-Q101-002	
	Human Body Model	Class H3A (+/- 6000V) <sup>†</sup> AEC-Q101-001	
	Charged Device Model	Class C5 (+/- 2000) <sup>†</sup> AEC-Q101-005	
<b>RoHS Compliant</b>		Yes	

† Highest passing voltage.

**Revision History**

Date	Comments
9/15/2017	<ul style="list-style-type: none"> <li>Updated datasheet with corporate template</li> <li>Corrected typo error on part marking on page 8.</li> </ul>

**Published by**

**Infineon Technologies AG**  
81726 München, Germany

© Infineon Technologies AG 2015

All Rights Reserved.

**IMPORTANT NOTICE**

The information given in this document shall in no event be regarded as a guarantee of conditions or characteristics ("Beschaffenhheitsgarantie"). With respect to any examples, hints or any typical values stated herein and/or any information regarding the application of the product, Infineon Technologies hereby disclaims any and all warranties and liabilities of any kind, including without limitation warranties of non-infringement of intellectual property rights of any third party.

In addition, any information given in this document is subject to customer's compliance with its obligations stated in this document and any applicable legal requirements, norms and standards concerning customer's products and any use of the product of Infineon Technologies in customer's applications.

The data contained in this document is exclusively intended for technically trained staff. It is the responsibility of customer's technical departments to evaluate the suitability of the product for the intended application and the completeness of the product information given in this document with respect to such application.

For further information on the product, technology, delivery terms and conditions and prices please contact your nearest Infineon Technologies office ([www.infineon.com](http://www.infineon.com)).

**WARNINGS**

Due to technical requirements products may contain dangerous substances. For information on the types in question please contact your nearest Infineon Technologies office.

Except as otherwise explicitly approved by Infineon Technologies in a written document signed by authorized representatives of Infineon Technologies, Infineon Technologies' products may not be used in any applications where a failure of the product or any consequences of the use thereof can reasonably be expected to result in personal injury.



## OUR CERTIFICATE

DiGi provide top-quality products and perfect service for customer worldwide through standardization, technological innovation and continuous improvement. DiGi through third-party certification, we stricly control the quality of products and services. Welcome your RFQ to

Email: [Info@DiGi-Electronics.com](mailto:Info@DiGi-Electronics.com)



Tel: +00 852-30501935

RFQ Email: [Info@DiGi-Electronics.com](mailto:Info@DiGi-Electronics.com)

DiGi is a global authorized distributor of electronic components.