

ASMD-CWG7-NX7F2 Datasheet

www.digi-electronics.com



<https://www.DiGi-Electronics.com>

DiGi Electronics Part Number	ASMD-CWG7-NX7F2-DG
Manufacturer	Broadcom Limited
Manufacturer Product Number	ASMD-CWG7-NX7F2
Description	LED WHITE/NEUTRAL 3014 SMD
Detailed Description	White, Neutral LED Indication - Discrete 2.8V 1206 (3014 Metric)

This model ASMD-CWG7-NX7F2 is available at DiGi Electronics.

DiGi Electronics offers a global database of semiconductor and electronic component datasheets.

We welcome your inquiries regarding pricing, lead time, or other product-related questions.

 [Request a Quote](#)

 [Datasheet Search](#)



Tel: +00 852-30501935

RFQ Email: Info@DiGi-Electronics.com

DiGi is a global authorized distributor of electronic components.

Purchase and inquiry

Manufacturer Product Number:

ASMD-CWG7-NX7F2

Series:

ASMD-CWG7

Color:

White, Neutral

Lens Color:

-

Millicandela Rating:

2800mcd

Lens Size:

2.50mm x 1.15mm

Current - Test:

20mA

Mounting Type:

Surface Mount

Wavelength - Peak:

-

Package / Case:

1206 (3014 Metric)

Size / Dimension:

3.00mm L x 1.40mm W

Base Product Number:

ASMD-CWG7

Manufacturer:

Broadcom Limited

Product Status:

Active

Configuration:

-

Lens Transparency:

-

Lens Style:

Rectangle with Flat Top

Voltage - Forward (Vf) (Typ):

2.8V

Viewing Angle:

120°

Wavelength - Dominant:

-

Features:

-

Supplier Device Package:

3014

Height (Max):

0.90mm

Environmental & Export classification

RoHS Status:

ROHS3 Compliant

ECCN:

EAR99

Moisture Sensitivity Level (MSL):

3 (168 Hours)

HTSUS:

8541.41.0000



ASMD-CWG7-NX7x2

Low-Power 3014 DFN2 Surface-Mount LED

Description

The Broadcom® ASMD-CWG7-NX7x2 surface-mount LEDs use InGaN chip technology with superior package design to enable them to produce higher light output with better luminous intensity performance. They can be driven at high current and are able to dissipate heat more efficiently resulting in better performance with higher reliability.

These LEDs operate under a wide range of environmental conditions, making them ideal for various applications including under-cabinet lighting, retail display lighting, and panel lights.

To facilitate easy pick-and-place assembly, the LEDs are packed in tape and reel. Every reel is shipped in single flux and color bin, to provide close uniformity.

Features

- High reliability package with enhanced silicone resin encapsulation
- Available in 2700K, 3000K, 3500K, 4000K, 4500K, 5000K, 5700K, 6500K, and 8000K CCT only
- Wide viewing angle at 120°
- Low package profile and large emitting area for better uniformity in linear lighting

Applications

- Electronic signs and signals
 - Channel lettering
 - Contour lighting
 - Indoor variable message sign
- Office automations, home appliances, industrial equipment
 - Front panel backlighting
 - Pushbutton backlighting
 - Display backlighting
 - Scanner lighting

CAUTION! This LED is ESD sensitive. Observe appropriate precautions during handling and processing. Refer to application note AN-1142 for additional details.

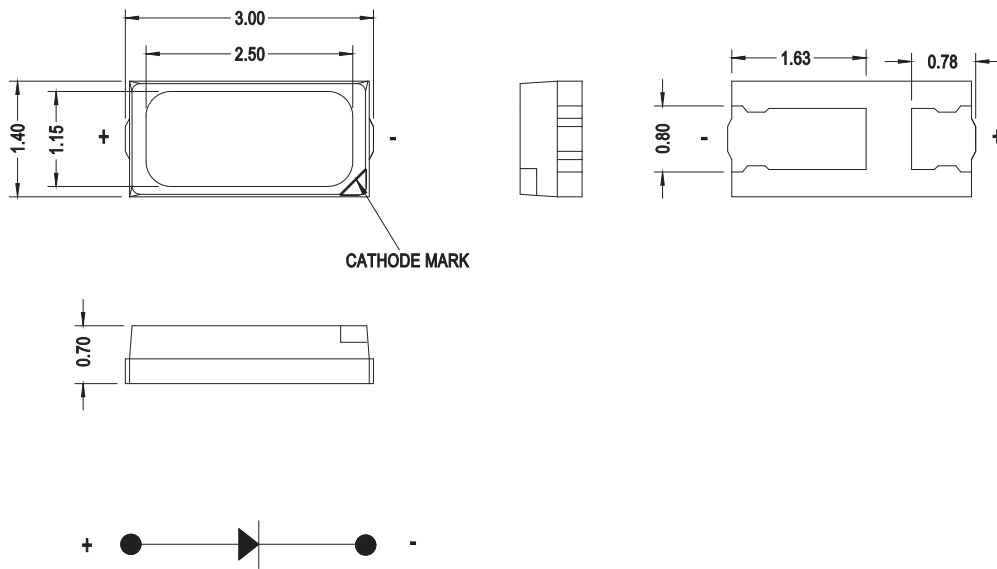
Figure 1: Package Drawing**NOTE:**

1. All dimensions are in millimeters (mm).
2. Tolerance is ± 0.20 mm unless otherwise specified.
3. Encapsulation = silicone.
4. Terminal finish = silver plating.
5. Dimensions in bracket are for reference only.

Device Selection Guide ($T_J = 25^\circ\text{C}$, $I_F = 20\text{ mA}$)

Part Number	Correlated Color Temperature, CCT (Kelvin)	Luminous Intensity, I_V (mcd) ^{a, b}			Luminous Flux, Φ_V (lm) ^c
	Typ.	Min.	Typ.	Max.	Typ.
ASMD-CWG7-NX7A2	8000	2240	2700	4500	8.1
ASMD-CWG7-NX7B2	6500	2240	2800	4500	8.6
ASMD-CWG7-NX7C2	5700	2240	2800	4500	8.6
ASMD-CWG7-NX7D2	5000	2240	2800	4500	8.6
ASMD-CWG7-NX7E2	4500	2240	2800	4500	8.4
ASMD-CWG7-NX7F2	4000	2240	2800	4500	8.4
ASMD-CWG7-NX7G2	3500	2240	2700	4500	8.1
ASMD-CWG7-NX7H2	3000	2240	2700	4500	8.1
ASMD-CWG7-NX7J2	2700	2240	2700	4500	8.1

- a. The luminous intensity, I_V , is measured at the mechanical axis of the LED package at a single current pulse condition. The actual peak of the spatial radiation pattern may not be aligned with the axis.
- b. Luminous intensity tolerance is $\pm 12\%$.
- c. For reference only.

Absolute Maximum Ratings

Parameters	ASMD-CWG7-NX7x2	Units
DC Forward Current ^a	30	mA
Peak Forward Current ^b	100	mA
Power Dissipation	102	mW
Reverse Voltage	Not designed for reverse bias operation	
LED Junction Temperature	110	$^\circ\text{C}$
Operating Temperature Range	-40 to +85	$^\circ\text{C}$
Storage Temperature Range	-40 to +85	$^\circ\text{C}$

- a. Derate linearly as shown in [Figure 14](#) and [Figure 15](#).
- b. Duty factor = 10%, frequency = 1 kHz.

Optical and Electrical Characteristics ($T_J = 25^\circ\text{C}$, $I_F = 20\text{ mA}$)

Parameters	Min.	Typ.	Max.	Units
Viewing Angle, $2\theta_{1/2}^a$	—	120	—	$^\circ$
Forward Voltage, V_F^b	2.60	2.80	3.40	V
Reverse Current, I_R at $V_R = 5V^c$	—	—	10	A
Color Rendering Index, CRI	80	—	—	
Thermal Resistance, $R_{\theta J-S}^d$	—	80	—	$^\circ\text{C/W}$

- $\theta_{1/2}$ is the off-axis angle where the luminous intensity is half of the peak intensity.
- Forward voltage tolerance is $\pm 0.1V$.
- Indicates product final test condition. Long term reverse bias is not recommended.
- Thermal resistance from LED junction to solder point.

Part Numbering System

A S M D - C W x₁ 7 - N x₂ x₃ x₄ 2

Code	Description	Option	
x ₁	Color Rendering Index	G	CRI \geq 80
x ₂	Minimum Intensity Bin	X	
x ₃	Number of Intensity Bins	7	3 intensity bins, starting from bin X2
x ₄	Color Correlated Temperature	A	8000K
		B	6500K
		C	5700K
		D	5000K
		E	4500K
		F	4000K
		G	3500K
		H	3000K
		J	2700K

Part Number Example

ASMD-CWG7-NX7H2

- x₁ : G – CRI \geq 80
 x₂ : X – Minimum intensity bin X
 x₃ : 7 – 3 intensity bins, starting from bin X2
 x₄ : H – CCT 3000K with bin ID 8A1, 8A2, 8A3, 8A4, 8B1, 8B2, 8B3, 8B4, 8C1, 8C2, 8C3, 8C4, 8D1, 8D2, 8D3, and 8D4
 x₅ : 2 – Test current = 20 mA

Bin Information

Luminous Intensity Bin Limits (CAT)

Bin ID	Luminous Intensity, I_V (mcd)	
	Min.	Max.
X2	2240	2850
Y1	2850	3550
Y2	3550	4500

Tolerance = $\pm 12\%$.

Forward Voltage Bin Limits (VF)

Bin ID	Forward Voltage, V_F (V)	
	Min.	Max.
G01	2.6	2.7
G02	2.7	2.8
G03	2.8	2.9
G04	2.9	3.0
G05	3.0	3.1
G06	3.1	3.2
G07	3.2	3.3
G08	3.3	3.4

Tolerance = $\pm 0.1V$.

Example of bin information on reel and packaging label:

CAT : X2 – Intensity bin X2

BIN : 9D1 — Color bin 9D1

VF : G05 — VF bin G05

Chromaticity Diagram (4500K to 8000K)

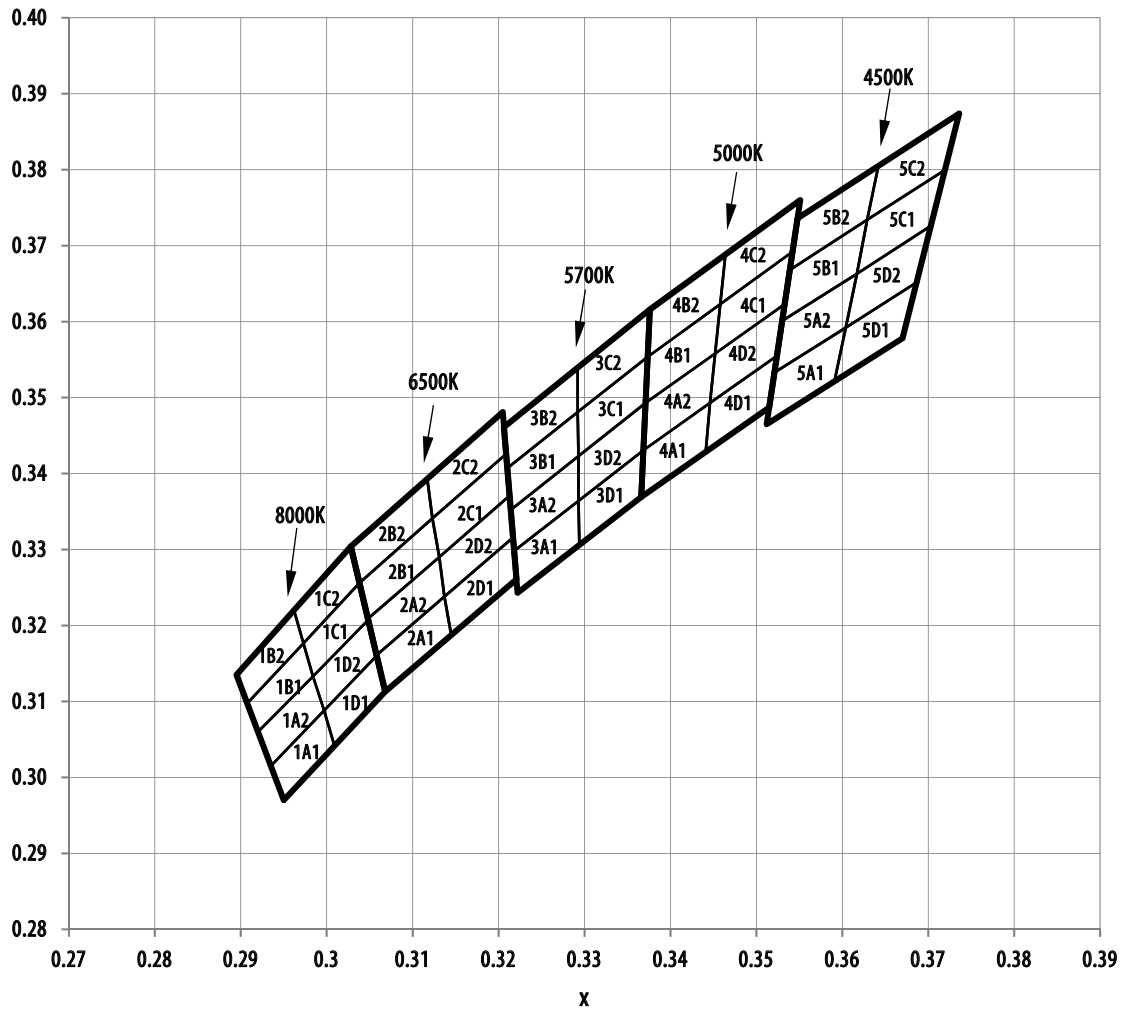

Chromaticity Diagram (2700K to 4000K)

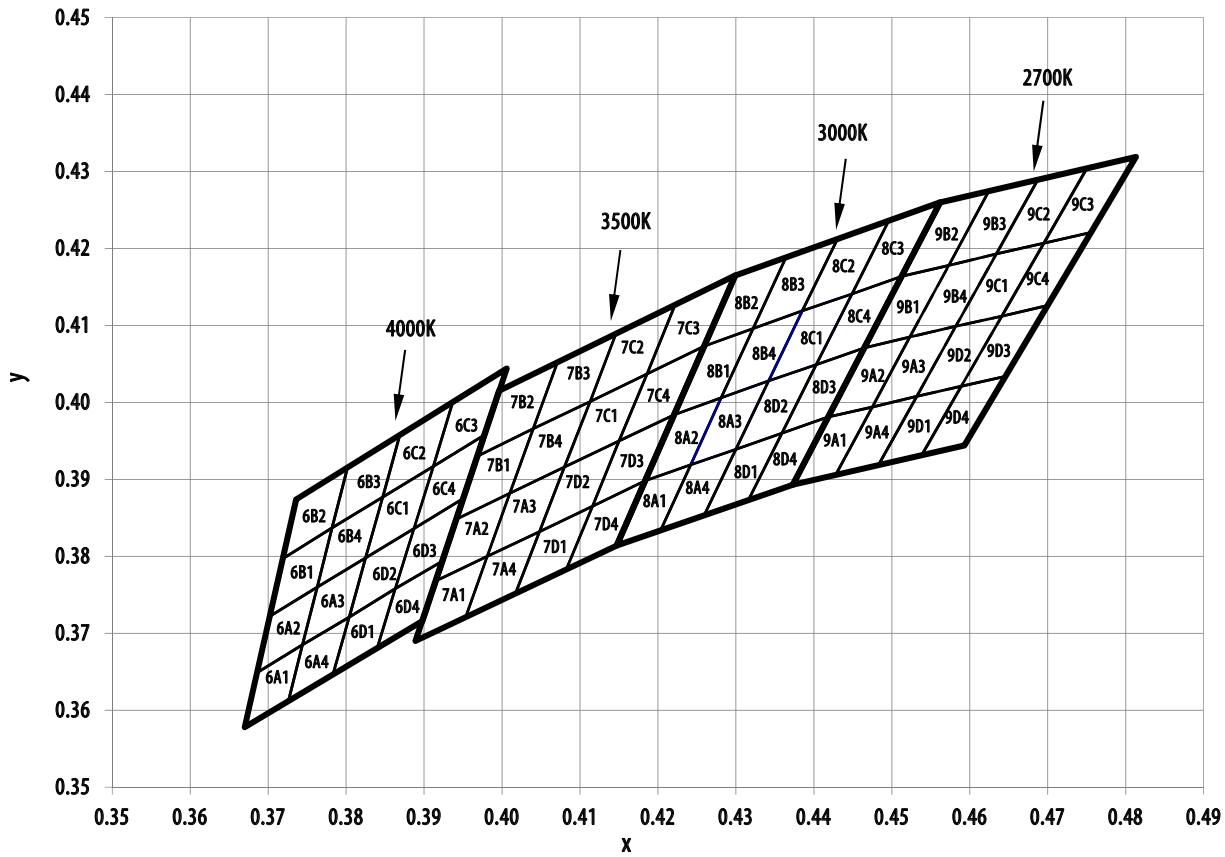

Color Bin Limits (BIN)

CCT	Bin ID	Chromaticity Coordinates		CCT	Bin ID	Chromaticity Coordinates		CCT	Bin ID	Chromaticity Coordinates	
		x	y			x	y			x	y
8000K	1A1	0.2935	0.3015	6500K	2A1	0.3058	0.3161	5700K	3A1	0.3218	0.3298
		0.2997	0.3088			0.3137	0.3238			0.3293	0.3364
		0.3009	0.3042			0.3145	0.3187			0.3294	0.3306
		0.2950	0.2970			0.3068	0.3113			0.3222	0.3243
	1A2	0.2935	0.3015		2A2	0.3048	0.3209		3A2	0.3214	0.3352
		0.2920	0.3060			0.3131	0.3290			0.3293	0.3423
		0.2984	0.3133			0.3137	0.3238			0.3293	0.3364
		0.2997	0.3088			0.3058	0.3161			0.3218	0.3298
	1B1	0.2920	0.3060		2B1	0.3038	0.3256		3B1	0.3210	0.3407
		0.2908	0.3098			0.3123	0.3341			0.3292	0.3481
		0.2973	0.3177			0.3131	0.3290			0.3293	0.3423
		0.2984	0.3133			0.3048	0.3209			0.3214	0.3352
	1B2	0.2908	0.3098		2B2	0.3028	0.3304		3B2	0.3206	0.3461
		0.2973	0.3177			0.3117	0.3393			0.3292	0.3539
		0.2962	0.3220			0.3123	0.3341			0.3292	0.3481
		0.2895	0.3135			0.3038	0.3256			0.3210	0.3407
	1C1	0.2984	0.3133		2C1	0.3123	0.3341		3C1	0.3292	0.3481
		0.2973	0.3177			0.3209	0.3426			0.3374	0.3554
		0.3038	0.3256			0.3213	0.3371			0.3371	0.3493
		0.3048	0.3207			0.3131	0.3290			0.3293	0.3423
	1C2	0.2973	0.3177		2C2	0.3117	0.3393		3C2	0.3292	0.3481
		0.2962	0.3220			0.3205	0.3481			0.3374	0.3554
		0.3028	0.3304			0.3209	0.3426			0.3376	0.3616
		0.3038	0.3256			0.3123	0.3341			0.3292	0.3539
1D1	0.3009	0.3042	2D1	0.3137	0.3238	3D1	0.3293	0.3364			
	0.2997	0.3088		0.3217	0.3316		0.3369	0.3431			
	0.3058	0.3160		0.3221	0.3261		0.3366	0.3369			
	0.3068	0.3113		0.3145	0.3187		0.3294	0.3306			
1D2	0.2997	0.3088	2D2	0.3131	0.3290	3D2	0.3293	0.3423			
	0.2984	0.3133		0.3213	0.3371		0.3371	0.3493			
	0.3048	0.3207		0.3217	0.3316		0.3369	0.3431			
	0.3058	0.3160		0.3137	0.3238		0.3293	0.3364			

Tolerance = ± 0.01 .

CCT	Bin ID	Chromaticity Coordinates		CCT	Bin ID	Chromaticity Coordinates		CCT	Bin ID	Chromaticity Coordinates	
		x	y			x	y			x	y
5000K	4A1	0.3369	0.3431	4500K	5A1	0.3521	0.3533	4000K	6A1	0.3670	0.3578
		0.3446	0.3493			0.3604	0.3592			0.3686	0.3649
		0.3441	0.3428			0.3591	0.3522			0.3744	0.3685
		0.3366	0.3369			0.3512	0.3465			0.3726	0.3612
	4A2	0.3371	0.3493		5A2	0.3530	0.3601		6A2	0.3686	0.3649
		0.3452	0.3558			0.3617	0.3663			0.3702	0.3722
		0.3446	0.3493			0.3604	0.3592			0.3763	0.3760
		0.3369	0.3431			0.3521	0.3533			0.3744	0.3685
	4B1	0.3374	0.3554		5B1	0.3539	0.3668		6A3	0.3744	0.3685
		0.3458	0.3623			0.3629	0.3734			0.3763	0.3760
		0.3452	0.3558			0.3617	0.3663			0.3825	0.3798
		0.3371	0.3493			0.3530	0.3601			0.3804	0.3721
	4B2	0.3374	0.3554		5B2	0.3548	0.3736		6A4	0.3726	0.3612
		0.3458	0.3623			0.3642	0.3805			0.3744	0.3685
		0.3464	0.3688			0.3629	0.3734			0.3804	0.3721
		0.3376	0.3616			0.3539	0.3668			0.3783	0.3646
	4C1	0.3542	0.3692		5C1	0.3629	0.3734		6B1	0.3702	0.3722
		0.3533	0.3623			0.3720	0.3800			0.3719	0.3797
		0.3452	0.3558			0.3703	0.3726			0.3782	0.3837
		0.3458	0.3623			0.3617	0.3663			0.3763	0.3760
	4C2	0.3458	0.3623		5C2	0.3642	0.3805		6B2	0.3719	0.3797
		0.3542	0.3692			0.3736	0.3874			0.3736	0.3874
		0.3551	0.3760			0.3720	0.3800			0.3802	0.3916
		0.3464	0.3688			0.3629	0.3734			0.3782	0.3837
	4D1	0.3446	0.3493		5D1	0.3604	0.3592		6B3	0.3782	0.3837
		0.3524	0.3555			0.3687	0.3652			0.3802	0.3916
		0.3515	0.3487			0.3670	0.3578			0.3869	0.3958
		0.3441	0.3428			0.3591	0.3522			0.3847	0.3877
	4D2	0.3452	0.3558		5D2	0.3617	0.3663		6B4	0.3763	0.3760
		0.3533	0.3623			0.3703	0.3726			0.3782	0.3837
		0.3524	0.3555			0.3687	0.3652			0.3847	0.3877
		0.3446	0.3493			0.3604	0.3592			0.3825	0.3798

Tolerance = ± 0.01 .

CCT	Bin ID	Chromaticity Coordinates		CCT	Bin ID	Chromaticity Coordinates		CCT	Bin ID	Chromaticity Coordinates	
		x	y			x	y			x	y
4000K	6C1	0.3825	0.3798	3500K	7A1	0.3889	0.3690	3500K	7C1	0.4080	0.3916
		0.3847	0.3877			0.3915	0.3768			0.4113	0.4001
		0.3912	0.3917			0.3981	0.3800			0.4186	0.4037
		0.3887	0.3836			0.3953	0.3720			0.4150	0.3950
	6C2	0.3847	0.3877		7A2	0.3915	0.3768		7C2	0.4113	0.4001
		0.3869	0.3958			0.3941	0.3848			0.4146	0.4089
		0.3937	0.4001			0.4010	0.3882			0.4222	0.4127
		0.3912	0.3917			0.3981	0.3800			0.4186	0.4037
	6C3	0.3912	0.3917		7A3	0.3981	0.3800		7C3	0.4186	0.4037
		0.3937	0.4001			0.4010	0.3882			0.4222	0.4127
		0.4006	0.4044			0.4080	0.3916			0.4299	0.4165
		0.3978	0.3958			0.4048	0.3832			0.4259	0.4073
	6C4	0.3887	0.3836		7A4	0.3953	0.3720		7C4	0.4150	0.3950
		0.3912	0.3917			0.3981	0.3800			0.4186	0.4037
		0.3978	0.3958			0.4048	0.3832			0.4259	0.4073
		0.3950	0.3875			0.4017	0.3751			0.4221	0.3984
	6D1	0.3783	0.3646		7B1	0.3941	0.3848		7D1	0.4017	0.3751
		0.3804	0.3721			0.3968	0.3930			0.4048	0.3832
		0.3863	0.3758			0.4040	0.3966			0.4116	0.3865
		0.3840	0.3681			0.4010	0.3882			0.4082	0.3782
	6D2	0.3804	0.3721		7B2	0.3968	0.3930		7D2	0.4048	0.3832
		0.3825	0.3798			0.3996	0.4015			0.4080	0.3916
		0.3887	0.3836			0.4071	0.4052			0.4150	0.3950
		0.3863	0.3758			0.4040	0.3966			0.4116	0.3865
	6D3	0.3863	0.3758		7B3	0.4040	0.3966		7D3	0.4116	0.3865
		0.3887	0.3836			0.4071	0.4052			0.4150	0.3950
		0.3950	0.3875			0.4146	0.4089			0.4221	0.3984
		0.3924	0.3794			0.4113	0.4001			0.4183	0.3898
	6D4	0.3840	0.3681		7B4	0.4010	0.3882		7D4	0.4082	0.3782
		0.3863	0.3758			0.4040	0.3966			0.4116	0.3865
		0.3924	0.3794			0.4113	0.4001			0.4183	0.3898
		0.3898	0.3716			0.4080	0.3916			0.4147	0.3814

Tolerance = ± 0.01 .

CCT	Bin ID	Chromaticity Coordinates		CCT	Bin ID	Chromaticity Coordinates		CCT	Bin ID	Chromaticity Coordinates	
		x	y			x	y			x	y
3000K	8A1	0.4147	0.3814	3000K	8C1	0.4342	0.4028	2700K	9A1	0.4373	0.3893
		0.4183	0.3898			0.4385	0.4119			0.4418	0.3981
		0.4242	0.3919			0.4449	0.4141			0.4475	0.3994
		0.4203	0.3833			0.4403	0.4049			0.4428	0.3906
	8A2	0.4183	0.3898		8C2	0.4385	0.4119		9A2	0.4418	0.3981
		0.4221	0.3984			0.4430	0.4212			0.4465	0.4071
		0.4281	0.4006			0.4496	0.4236			0.4523	0.4085
		0.4242	0.3919			0.4449	0.4141			0.4475	0.3994
	8A3	0.4242	0.3919		8C3	0.4449	0.4141		9A3	0.4475	0.3994
		0.4281	0.4006			0.4496	0.4236			0.4523	0.4085
		0.4342	0.4028			0.4562	0.4260			0.4582	0.4099
		0.4300	0.3939			0.4513	0.4164			0.4532	0.4008
	8A4	0.4203	0.3833		8C4	0.4403	0.4049		9A4	0.4428	0.3906
		0.4242	0.3919			0.4449	0.4141			0.4475	0.3994
		0.4300	0.3939			0.4513	0.4164			0.4532	0.4008
		0.4259	0.3853			0.4465	0.4071			0.4483	0.3919
	8B1	0.4221	0.3984		8D1	0.4259	0.3853		9B1	0.4465	0.4071
		0.4259	0.4073			0.4300	0.3939			0.4513	0.4164
		0.4322	0.4096			0.4359	0.3960			0.4573	0.4178
		0.4281	0.4006			0.4316	0.3873			0.4523	0.4085
	8B2	0.4259	0.4073		8D2	0.4300	0.3939		9B2	0.4513	0.4164
		0.4299	0.4165			0.4342	0.4028			0.4562	0.4260
		0.4364	0.4188			0.4403	0.4049			0.4624	0.4274
		0.4322	0.4096			0.4359	0.3960			0.4573	0.4178
	8B3	0.4322	0.4096		8D3	0.4359	0.3960		9B3	0.4573	0.4178
		0.4364	0.4188			0.4403	0.4049			0.4624	0.4274
		0.4430	0.4212			0.4465	0.4071			0.4687	0.4289
		0.4385	0.4119			0.4418	0.3981			0.4634	0.4193
	8B4	0.4281	0.4006		8D4	0.4316	0.3873		9B4	0.4523	0.4085
		0.4322	0.4096			0.4359	0.3960			0.4573	0.4178
		0.4385	0.4119			0.4418	0.3981			0.4634	0.4193
		0.4342	0.4028			0.4373	0.3893			0.4582	0.4099

Tolerance = ± 0.01 .

CCT	Bin ID	Chromaticity Coordinates	
		x	y
2700K	9C1	0.4582	0.4099
		0.4634	0.4193
		0.4695	0.4207
		0.4641	0.4112
	9C2	0.4634	0.4193
		0.4687	0.4289
		0.4750	0.4304
		0.4695	0.4207
	9C3	0.4695	0.4207
		0.4750	0.4304
		0.4813	0.4319
		0.4756	0.4221
	9C4	0.4641	0.4112
		0.4695	0.4207
		0.4756	0.4221
		0.4700	0.4126
	9D1	0.4483	0.3919
		0.4532	0.4008
		0.4589	0.4021
		0.4538	0.3931
	9D2	0.4532	0.4008
		0.4582	0.4099
		0.4641	0.4112
		0.4589	0.4021
	9D3	0.4589	0.4021
		0.4641	0.4112
		0.4700	0.4126
		0.4646	0.4034
	9D4	0.4538	0.3931
		0.4589	0.4021
		0.4646	0.4034
		0.4593	0.3944

Tolerance = ± 0.01 .

Figure 2: Spectral Power Distribution

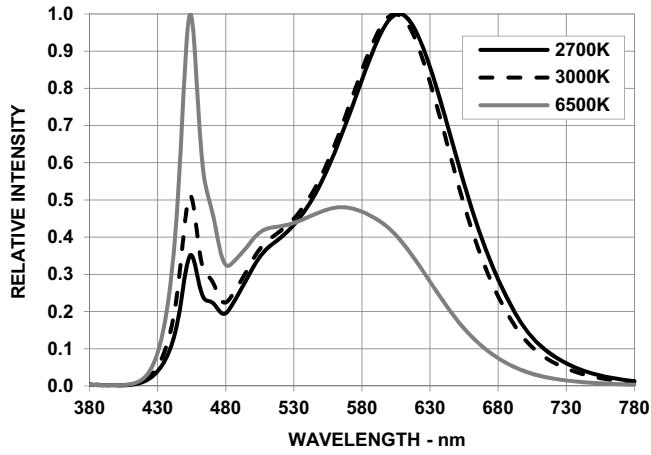

Figure 3: Forward Current vs. Forward Voltage

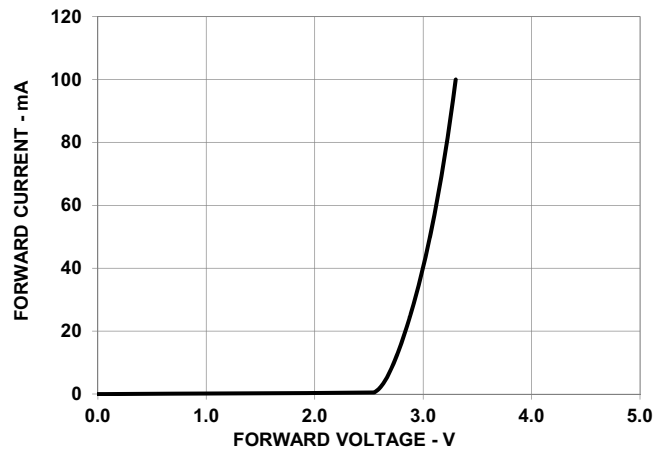

Figure 4: Relative Luminous Intensity vs. Mono Pulse Current

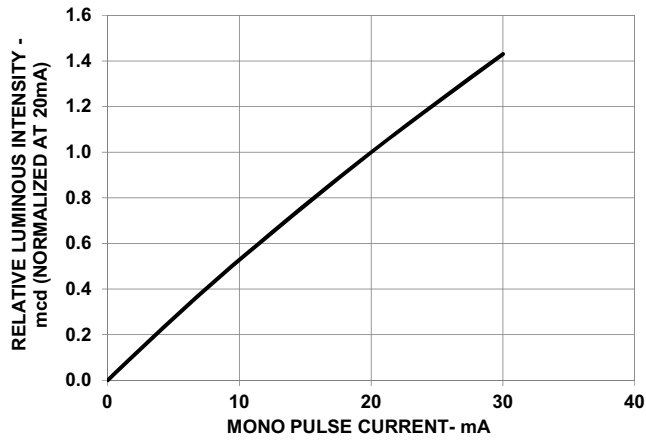

Figure 5: Radiation Pattern

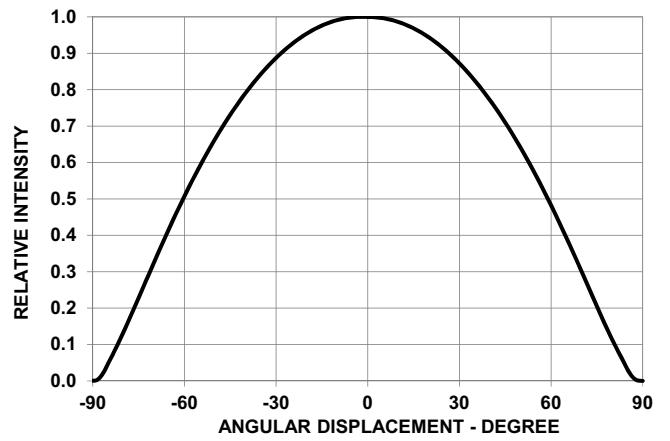

Figure 6: Chromaticity Coordinate Shift vs. Mono Pulse Current (2700K)

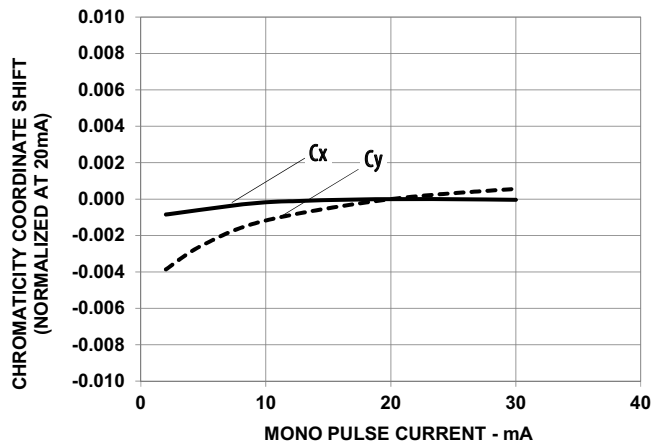

Figure 7: Chromaticity Coordinate Shift vs. Mono Pulse Current (3000K)

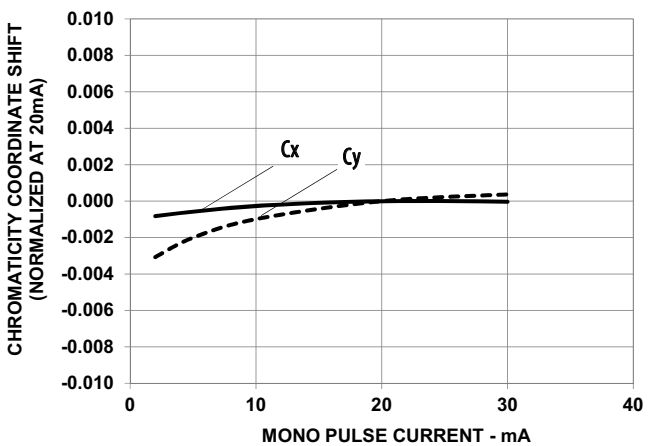

Figure 8: Chromaticity Coordinate Shift vs. Mono Pulse Current (6500K)

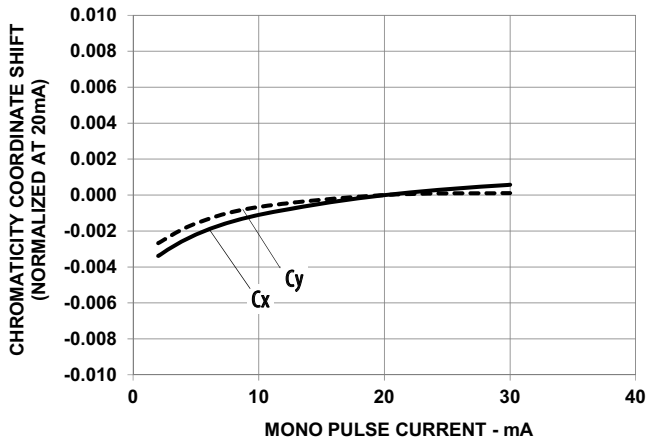

Figure 9: Forward Voltage Shift vs. Junction Temperature

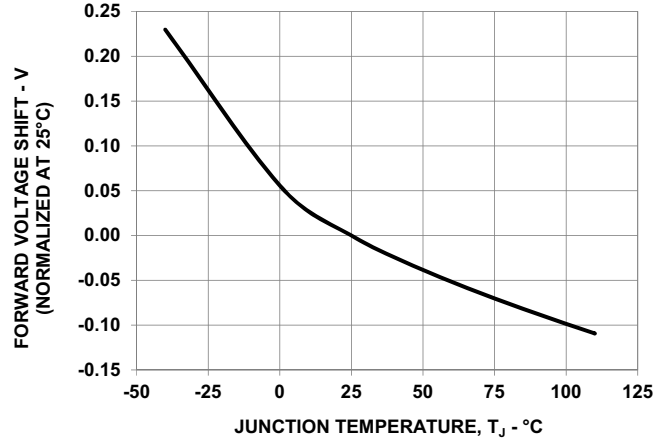

Figure 10: Relative Luminous Intensity vs Junction Temperature

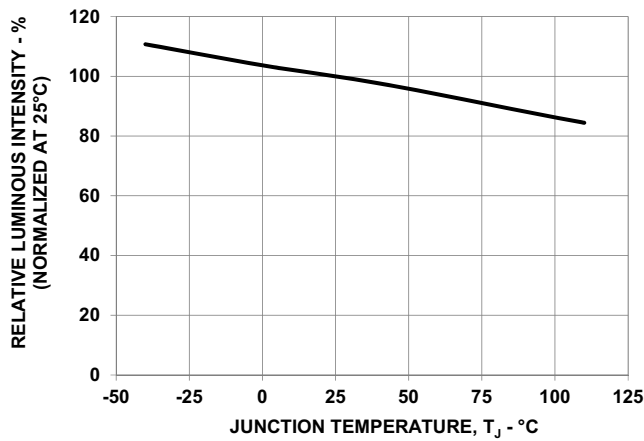

Figure 11: Chromaticity Coordinate Shift vs. Junction Temperature (2700K)

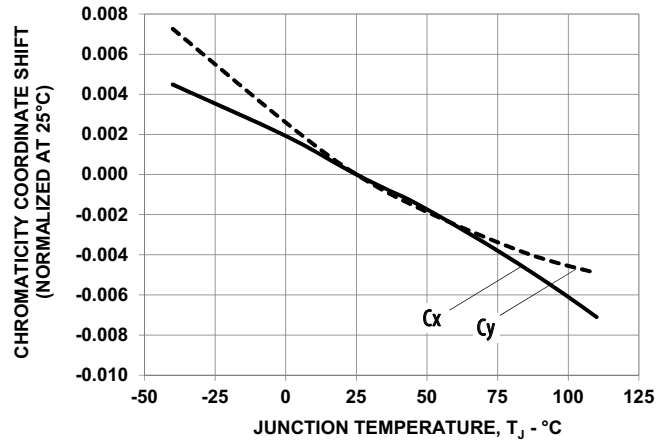

Figure 12: Chromaticity Coordinate Shift vs. Junction Temperature (3000K)

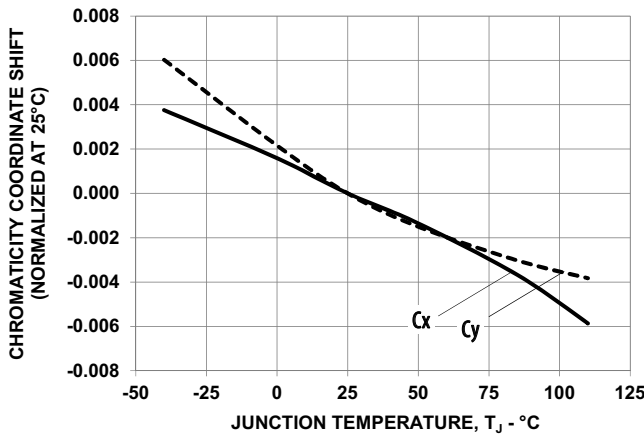

Figure 13: Chromaticity Coordinate Shift vs. Junction Temperature (6500K)

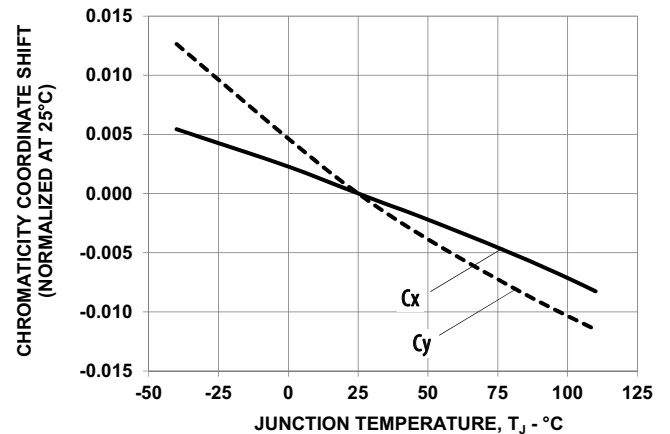

Figure 14: Maximum Forward Current vs. Ambient Temperature. Derated based on $T_{JMAX} = 110^{\circ}C$

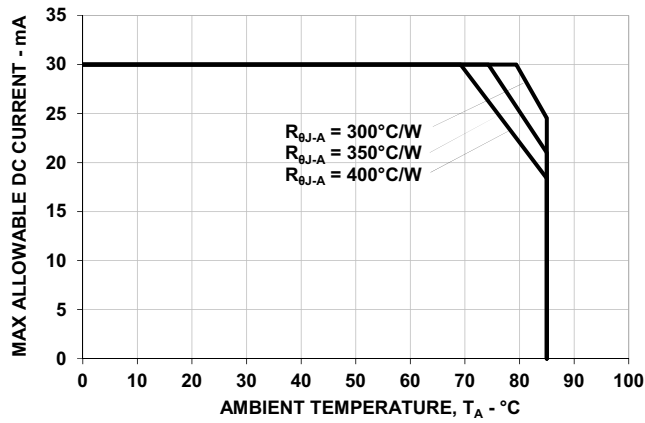

Figure 15: Maximum Forward Current vs. Solder Point Temperature. Derated based on $T_{JMAX} = 110^{\circ}C$, $R_{\theta J-S} = 80^{\circ}C/W$

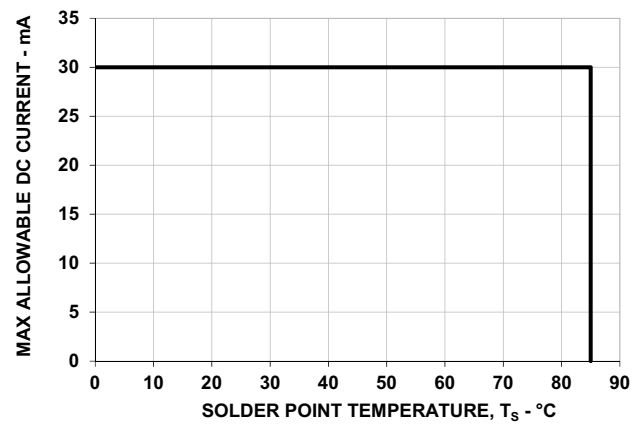
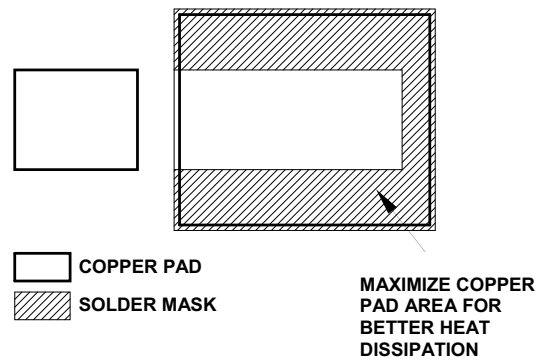
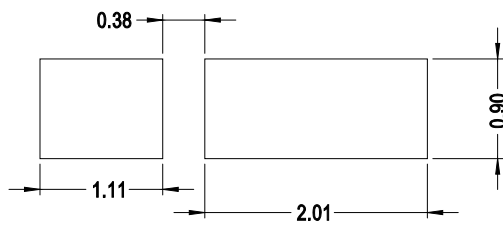
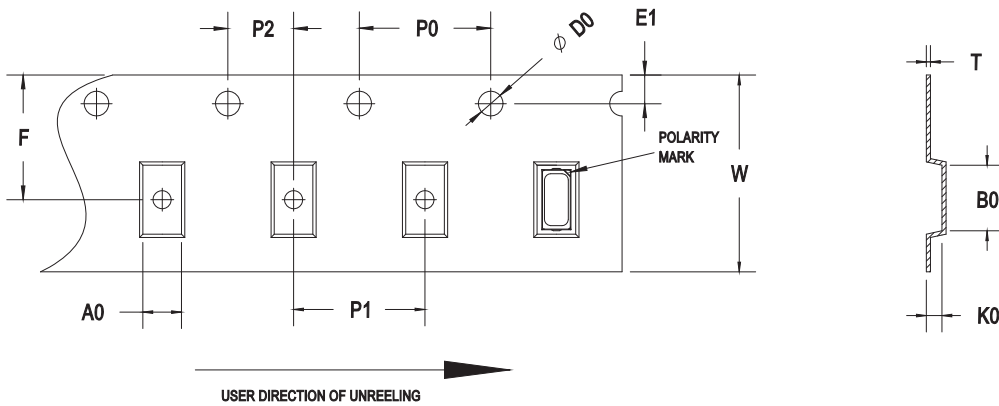

Figure 16: Recommended Soldering Land Pattern



NOTE: All dimensions are in millimeters (mm).

Figure 17: Carrier Tape Dimensions



F	P0	P1	P2	D0	E1	W
3.5±0.10	4.0±0.1	4.0±0.1	2.0±0.05	1.60±0.05	1.75±0.1	8.0±0.3

T	B0	K0	A0
0.2±0.05	3.25±0.1	0.95±0.1	1.6±0.1

NOTE: All dimensions are in millimeters (mm).

Figure 18: Reel Dimensions

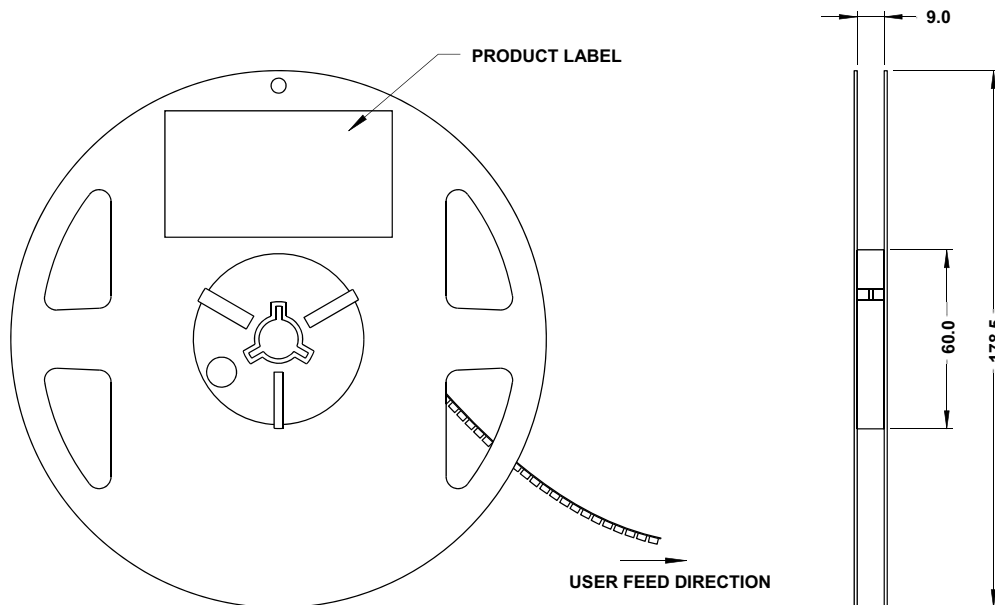

NOTE: All dimensions are in millimeters (mm).

Precautionary Notes

Soldering

- Do not perform reflow soldering more than twice. Observe necessary precautions of handling moisture-sensitive device as stated in the following section.
- Do not apply any pressure or force on the LED during reflow and after reflow when the LED is still hot.
- Use reflow soldering to solder the LED. Use hand soldering only for rework if unavoidable, but it must be strictly controlled to following conditions:
 - Soldering iron tip temperature = 315°C maximum.
 - Soldering duration = 3 seconds maximum.
 - Number of cycles = 1 only
 - Power of soldering iron = 50W maximum.
- Do not touch the LED package body with the soldering iron except for the soldering terminals, as it may cause damage to the LED.
- Confirm beforehand whether the functionality and performance of the LED is affected by soldering with hand soldering.

Figure 19: Recommended Lead-Free Reflow Soldering Profile

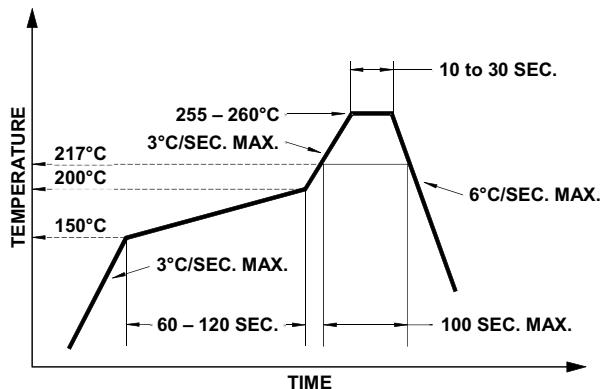

Handling Precautions

The encapsulation material of the LED is made of silicone for better product reliability. Compared to epoxy encapsulant, which is hard and brittle, silicone is softer and flexible. Observe special handling precautions during assembly of silicone encapsulated LED products. Failure to comply might lead to damage and premature failure of the LED. Refer to Broadcom Application Note AN5288, *Silicone Encapsulation for LED: Advantages and Handling Precautions*, for additional information.

- Do not poke sharp objects into the silicone encapsulant. Sharp objects, such as tweezers or syringes, might apply excessive force or even pierce through the silicone and induce failures to the LED die or wire bond.
- Do not touch the silicone encapsulant. Uncontrolled force acting on the silicone encapsulant might result in excessive stress on the wire bond. Hold the LED only by the body.
- Do not stack assembled PCBs together. Use an appropriate rack to hold the PCBs.
- Surface of silicone material attracts dust and dirt easier than epoxy due to its surface tackiness. To remove foreign particles on the surface of silicone, use a cotton bud with isopropyl alcohol (IPA). During cleaning, rub the surface gently without putting too much pressure on the silicone. Ultrasonic cleaning is not recommended.
- For automated pick and place, Broadcom has tested a nozzle size with OD 1.5 mm to work with this LED. However, due to the possibility of variations in other parameters such as pick and place machine maker/model, and other settings of the machine, verify that the selected nozzle will not cause damage to the LED.

Handling of Moisture-Sensitive Devices

This product has a Moisture Sensitive Level 3 rating per JEDEC J-STD-020. Refer to Broadcom Application Note AN5305, *Handling of Moisture Sensitive Surface Mount Devices*, for additional details and a review of proper handling procedures.

Before use:

- An unopened moisture barrier bag (MBB) can be stored at $40^{\circ}\text{C}/90\% \text{ RH}$ for 12 months. If the actual shelf life has exceeded 12 months and the humidity indicator card (HIC) indicates that baking is not required, it is safe to reflow the LEDs per the original MSL rating.
- Do not open the MBB prior to assembly (for example, for IQC). If unavoidable, the MBB must be properly resealed with fresh desiccant and a HIC. The exposed duration must be taken in as floor life.

Control after opening the MBB:

- Read the HIC immediately upon opening of the MBB.
- Keep the LEDs at $30^{\circ}\text{C}/60\% \text{ RH}$ at all times, and complete all high temperature-related processes, including soldering, curing, or rework within 168 hours.

Control for unfinished reel:

Store unused LEDs in a sealed MBB with desiccant or a desiccator at $5\% \text{ RH}$.

Control of assembled boards:

If the PCB soldered with the LEDs is to be subjected to other high-temperature processes, store the PCB in a sealed MBB with desiccant or desiccator at $5\% \text{ RH}$ to ensure that all LEDs have not exceeded their floor life of 168 hours.

Baking is required if the following conditions exist:

- The HIC indicator indicates a change in color for 10% and 5%, as stated on the HIC.
- The LEDs are exposed to conditions of $30^{\circ}\text{C}/60\% \text{ RH}$ at any time.
- The LED's floor life exceeded 168 hours.

The recommended baking condition is: $60^{\circ}\text{C} \pm 5^{\circ}\text{C}$ for 20 hours.

Baking can only be done once.

Storage:

The soldering terminals of these Broadcom LEDs are silver plated. If the LEDs are exposed in an ambient environment for too long, the silver plating might be oxidized, thus affecting its solderability performance. As such, keep unused LEDs in a sealed MBB with desiccant or in a desiccator at $5\% \text{ RH}$.

Application Precautions

- The drive current of the LED must not exceed the maximum allowable limit across temperature as stated in the data sheet. Constant current driving is recommended to ensure consistent performance.
- Circuit design must cater to the whole range of forward voltage (V_F) of the LEDs to ensure the intended drive current can always be achieved.
- The LED exhibits slightly different characteristics at different drive currents, which may result in a larger variation of performance (such as intensity, wavelength, and forward voltage). Set the application current as close as possible to the test current to minimize these variations.
- Do not use the LED in the vicinity of material with sulfur content or in environments of high gaseous sulfur compounds and corrosive elements. Examples of material that might contain sulfur are rubber gaskets, room-temperature vulcanizing (RTV) silicone rubber, rubber gloves, and so on. Prolonged exposure to such environments may affect the optical characteristics and product life.
- White LEDs must not be exposed to acidic environments and must not be used in the vicinity of any compound that may have acidic outgas, such as, but not limited to, acrylate adhesive. These environments have an adverse effect on LED performance.
- Avoid rapid changes in ambient temperature, especially in high-humidity environments, because they cause condensation on the LED.
- If the LED is intended to be used in harsh or outdoor environments, protect the LED against damages caused by rain, water, dust, oil, corrosive gases, external mechanical stresses, and so on.

Thermal Management

The optical, electrical, and reliability characteristics of the LED are affected by temperature. Keep the junction temperature (T_J) of the LED below the allowable limit at all times. T_J can be calculated as follows:

$$T_J = T_A + R_{\theta J-A} \times I_F \times V_{Fmax}$$

where:

T_A = Ambient temperature ($^{\circ}\text{C}$)

$R_{\theta J-A}$ = Thermal resistance from LED junction to ambient ($^{\circ}\text{C}/\text{W}$)

I_F = Forward current (A)

V_{Fmax} = Maximum forward voltage (V)

The complication of using this formula lies in T_A and $R_{\theta J-A}$. Actual T_A is sometimes subjective and hard to determine. $R_{\theta J-A}$ varies from system to system depending on design and is usually not known.

Another way of calculating T_J is by using the solder point temperature, T_S as follows:

$$T_J = T_S + R_{\theta J-S} \times I_F \times V_{Fmax}$$

where:

T_S = LED solder point temperature as shown in the following figure ($^{\circ}\text{C}$)

$R_{\theta J-S}$ = Thermal resistance from junction to solder point ($^{\circ}\text{C}/\text{W}$)

I_F = Forward current (A)

V_{Fmax} = Maximum forward voltage (V)

Figure 20: Solder Point Temperature on PCB

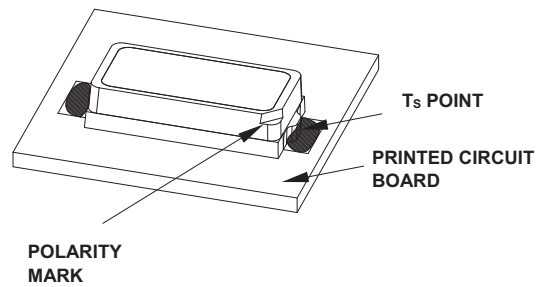

T_S can be easily measured by mounting a thermocouple on the soldering joint as shown in preceding figure, while $R_{\theta J-S}$ is provided in the data sheet. Verify the T_S of the LED in the final product to ensure that the LEDs are operating within all maximum ratings stated in the data sheet.

Eye Safety Precautions

LEDs may pose optical hazards when in operation. Do not look directly at operating LEDs because it might be harmful to the eyes. For safety reasons, use appropriate shielding or personal protective equipment.

Disclaimer

Broadcom's products and software are not specifically designed, manufactured, or authorized for sale as parts, components, or assemblies for the planning, construction, maintenance, or direct operation of a nuclear facility or for use in medical devices or applications. The customer is solely responsible, and waives all rights to make claims against Broadcom or its suppliers, for all loss, damage, expense, or liability in connection with such use.

Copyright © 2019–2022 Broadcom. All Rights Reserved. The term “Broadcom” refers to Broadcom Inc. and/or its subsidiaries. For more information, go to www.broadcom.com. All trademarks, trade names, service marks, and logos referenced herein belong to their respective companies.

Broadcom reserves the right to make changes without further notice to any products or data herein to improve reliability, function, or design. Information furnished by Broadcom is believed to be accurate and reliable. However, Broadcom does not assume any liability arising out of the application or use of this information, nor the application or use of any product or circuit described herein, neither does it convey any license under its patent rights nor the rights of others.

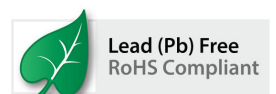

OUR CERTIFICATE

DiGi provide top-quality products and perfect service for customer worldwide through standardization, technological innovation and continuous improvement. DiGi through third-party certification, we stricly control the quality of products and services. Welcome your RFQ to

Email: Info@DiGi-Electronics.com



Tel: +00 852-30501935

RFQ Email: Info@DiGi-Electronics.com

DiGi is a global authorized distributor of electronic components.