

SPRH127-101M Datasheet

www.digi-electronics.com

AEC-Q200



<https://www.DiGi-Electronics.com>

DiGi Electronics Part Number	SPRH127-101M-DG
Manufacturer	CODACA
Manufacturer Product Number	SPRH127-101M
Description	SMD LOW LOSS POWER INDUCTOR
Detailed Description	100 μ H Shielded Drum Core, Wirewound Inductor 2 .4 A 164mOhm Max 2-SMD Drum Core, High Current, Low DCR



Tel: +00 852-30501935

RFQ Email: Info@DiGi-Electronics.com

DiGi is a global authorized distributor of electronic components.

Purchase and inquiry

Manufacturer Product Number:

SPRH127-101M

Series:

SPRH127

Type:

Drum Core, Wirewound

Inductance:100 μ H**Current Rating (Amps):**

2.4 A

Shielding:

Shielded

Q @ Freq:

-

Ratings:

-

Inductance Frequency - Test:

100 kHz

Mounting Type:

Surface Mount

Supplier Device Package:

2-SMD

Height - Seated (Max):

0.307" (7.80mm)

Manufacturer:

CODACA

Product Status:

Active

Material - Core:

Ferrite

Tolerance: \pm 20%**Current - Saturation (Isat):**

3.36A

DC Resistance (DCR):

164mOhm Max

Frequency - Self Resonant:

-

Operating Temperature:

-40°C ~ 125°C

Features:

Drum Core, High Current, Low DCR

Package / Case:

2-SMD

Size / Dimension:

0.472" L x 0.472" W (12.00mm x 12.00mm)

Environmental & Export classification

RoHS Status:

ROHS3 Compliant

REACH Status:

REACH Unaffected

HTSUS:

8504.50.8000

Moisture Sensitivity Level (MSL):

1 (Unlimited)

ECCN:

EAR99

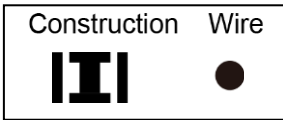

Outline:

- 12.3 x 12.3mm Max.(L x W),8.05mm Max.Height
- Carrier tape packing, suitable for SMT process
- Low DCR and excellent current handling
- Magnetically shielded construction
- In addition to the standard versions of inductors shown here custom inductors are available to meet your exact requirements

Features:

- Core material:Ferrite
- Core and winding loss:
- Environmental: RoHS, Reach compliant ,Halogen free
- Weight:4.09g
- Moisture Sensitivity:Level (MSL) 1 (unlimited floor life at <30°C / 85% relative humidity).
- Operating temperature range: -40°C ~ +125°C (including coil's self temperature rise)
- Storage temperature range: -40°C~+125°C

Application:

- Ideally used in Notebook PC,LCD T,Game machine STB
- buck converter, network communication equipment, and etc

1 Electrical Characteristics

Part No.	Inductance (μH)×1	D.C.R. (mΩ)		Isat (A)×2	Irms (A) ×3
		Typical	Max.	Typical	Typical
SPRH127-1R4N	1.40±30%	6.37	7.64	26.20	11.0
SPRH127-2R2N	2.20±30%	9.54	11.5	21.30	9.10
SPRH127-3R3N	3.30±30%	11.2	13.4	18.30	8.40
SPRH127-4R7N	4.70±30%	14.7	17.6	15.20	7.80
SPRH127-5R6N	5.60±30%	15.9	19.2	13.70	7.30
SPRH127-6R8N	6.80±30%	16.2	19.4	12.70	7.00
SPRH127-8R2N	8.20±30%	18.0	21.6	11.50	6.60
SPRH127-100M	10.0±20%	19.8	23.7	10.42	6.30
SPRH127-120M	12.0±20%	21.7	26.1	9.61	6.00
SPRH127-150M	15.0±20%	28.7	34.4	8.40	5.10
SPRH127-180M	18.0±20%	31.2	37.4	7.60	5.00
SPRH127-220M	22.0±20%	39.0	46.8	6.90	4.50
SPRH127-270M	27.0±20%	44.1	52.9	6.22	4.20
SPRH127-330M	33.0±20%	56.3	67.5	5.68	3.70
SPRH127-390M	39.0±20%	62.7	75.2	5.14	3.50
SPRH127-470M	47.0±20%	71.5	85.8	4.60	3.30
SPRH127-560M	56.0±20%	83.4	100	4.46	3.00
SPRH127-680M	68.0±20%	103	123	3.90	2.70
SPRH127-820M	82.0±20%	119	143	3.51	2.50
SPRH127-101M	100±20%	137	164	3.36	2.40
SPRH127-121M	120±20%	182	218	2.91	2.10
SPRH127-151M	150±20%	206	247	2.60	1.90
SPRH127-181M	180±20%	250	300	2.57	1.75
SPRH127-221M	220±20%	300	360	2.22	1.63
SPRH127-271M	270±20%	380	456	1.94	1.40
SPRH127-331M	330±20%	467	560	1.79	1.20
SPRH127-391M	380±20%	525	630	1.63	1.10
SPRH127-471M	470±20%	683	819	1.48	1.00
SPRH127-561M	560±20%	767	920	1.36	0.98
SPRH127-681M	680±20%	986	1,183	1.25	0.90
SPRH127-821M	820±20%	1,172	1,406	1.16	0.80
SPRH127-102M	1000±20%	1,322	1,586	1.01	0.70

2 Product Dimensions (mm)

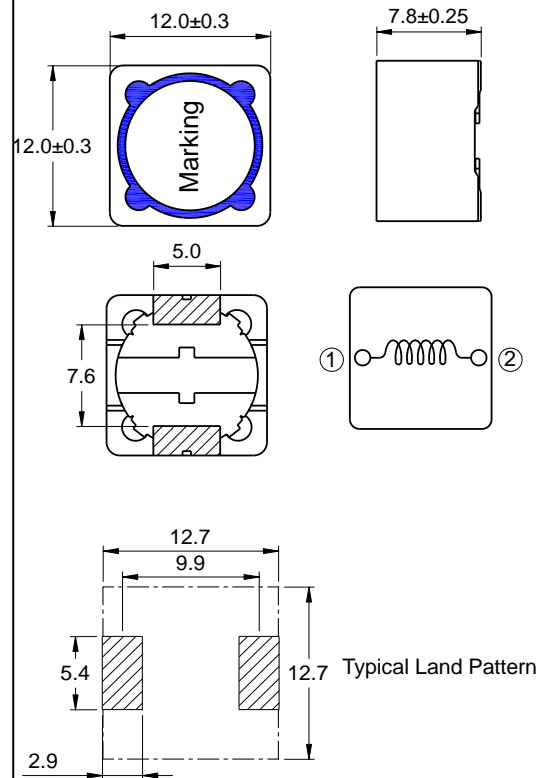

All data is tested on 25°C ambient temperature

1. Inductance measure condition at 100kHz,0.1V
2. Isat:the actual value of DC current when the Inductance decrease 20% of its initial value
3. Irms:the actual value of DC current when the the temperature rise is ΔT40°C(Ta=25°C)



SMD Power Inductor SPRH127 Series

3 Saturation Current vs Temperature Rise Current Curve

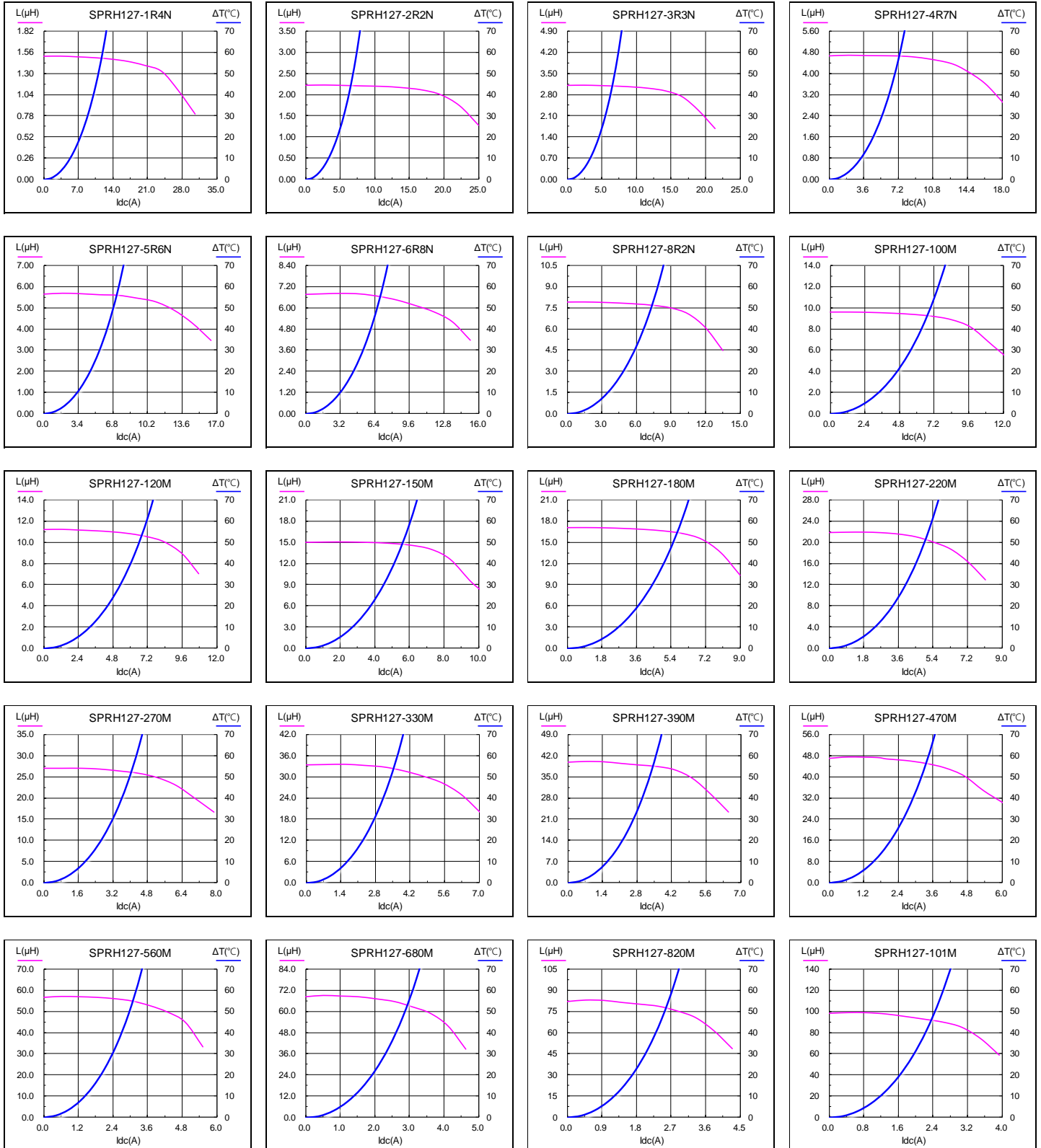



SMD Power Inductor SPRH127 Series

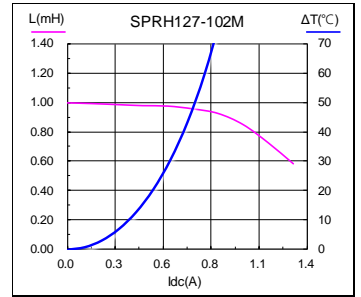
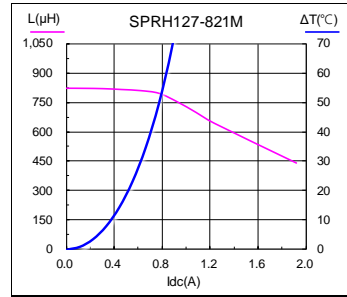
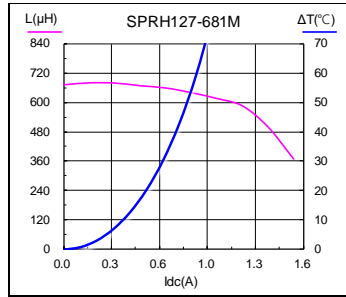
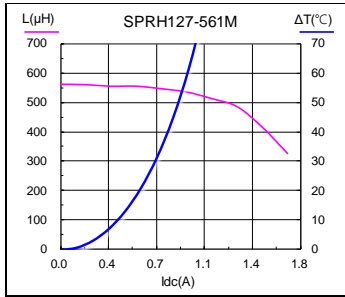
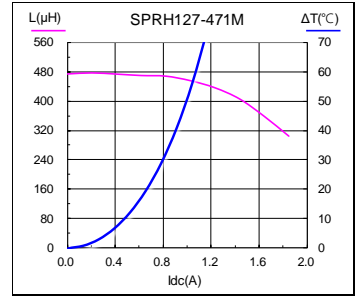
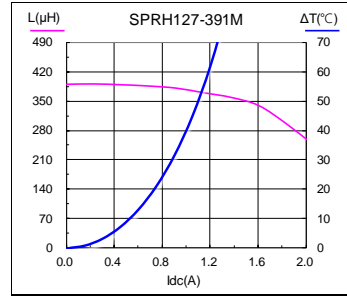
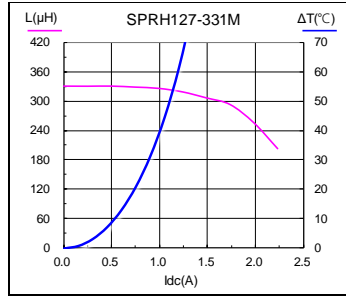
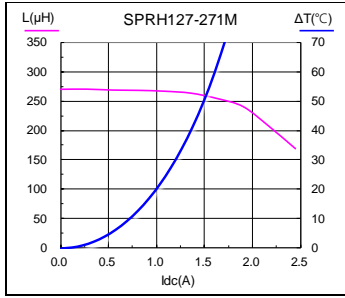
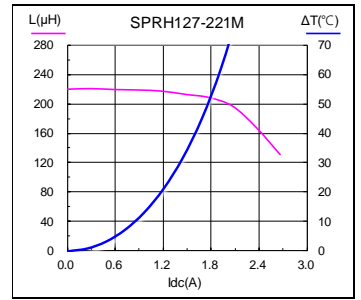
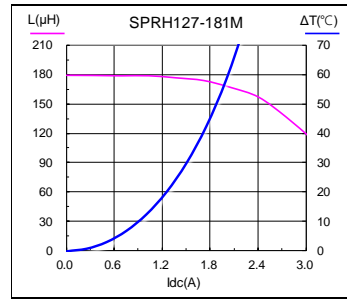
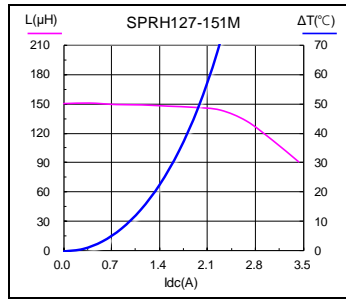
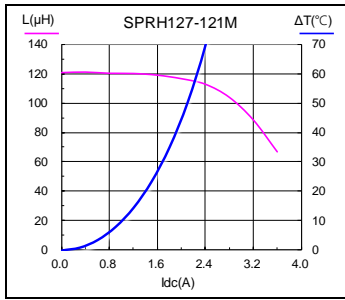



SMD Power Inductor SPRH127 Series

4 L vs Frequency

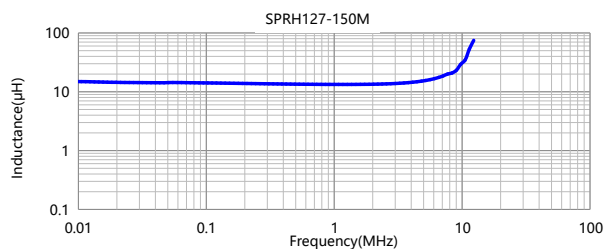
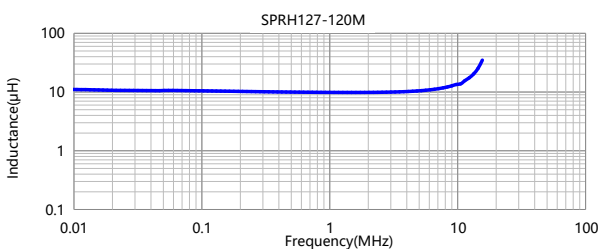
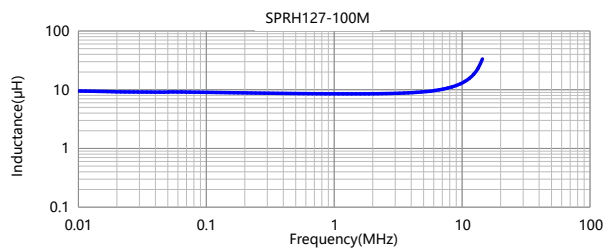
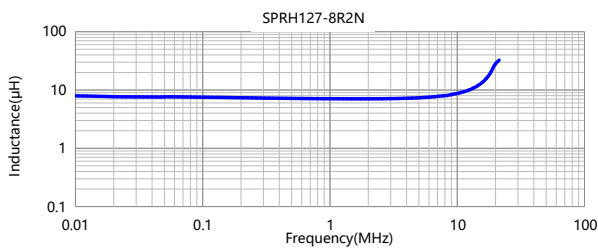
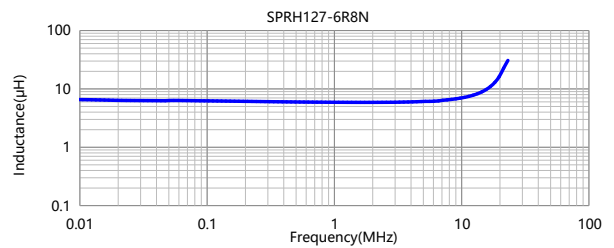
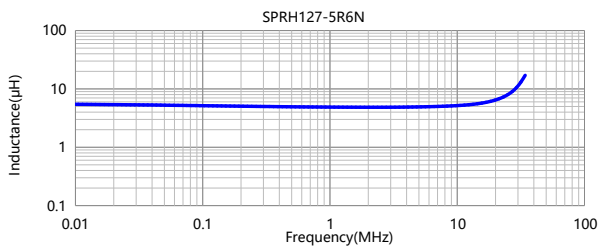
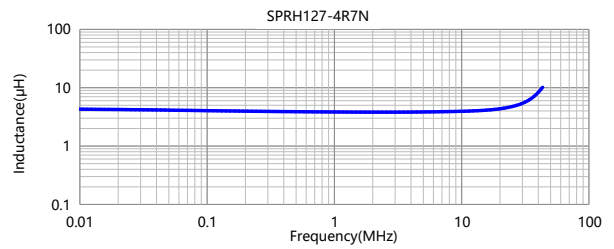
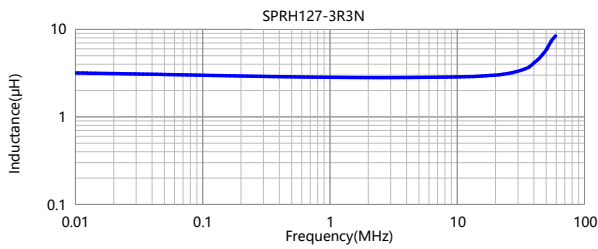
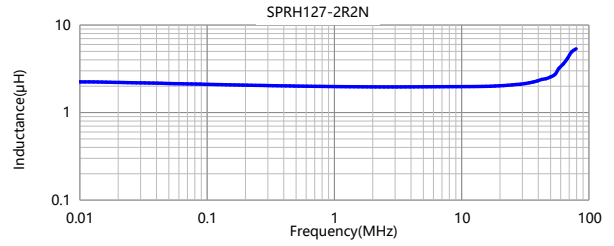
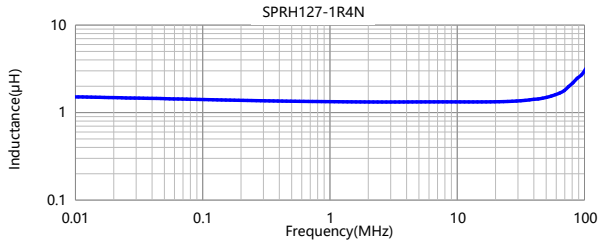



SMD Power Inductor SPRH127 Series

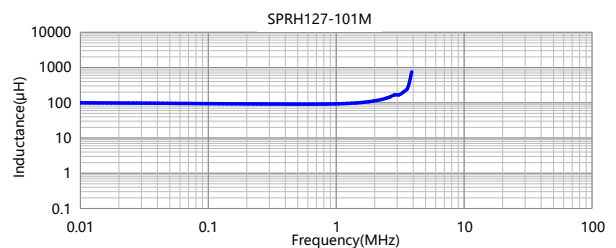
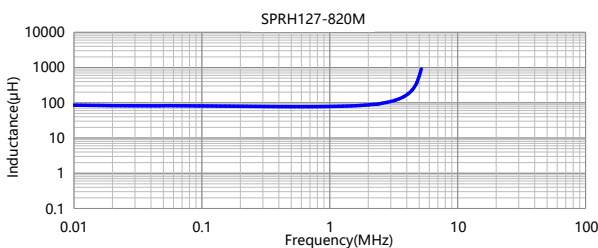
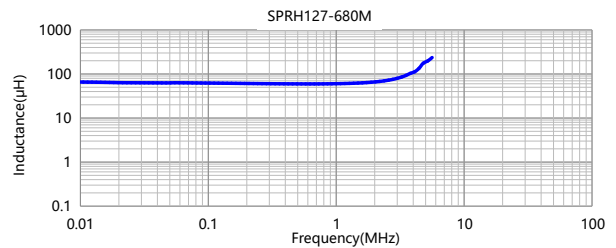
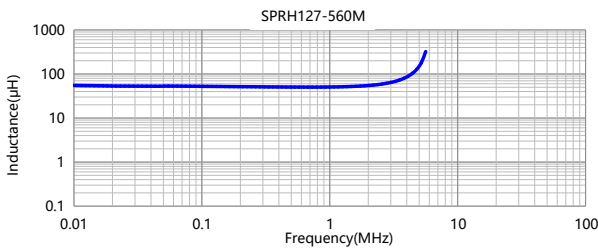
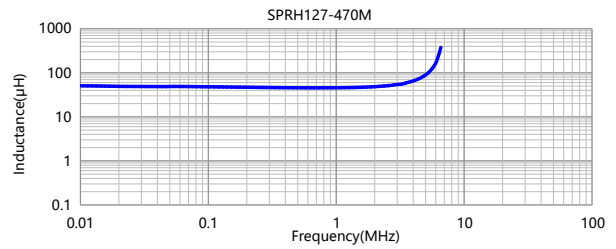
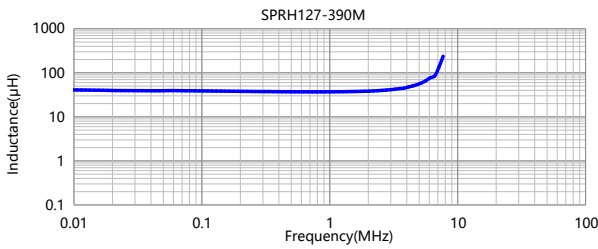
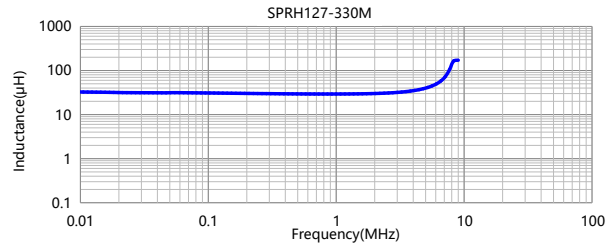
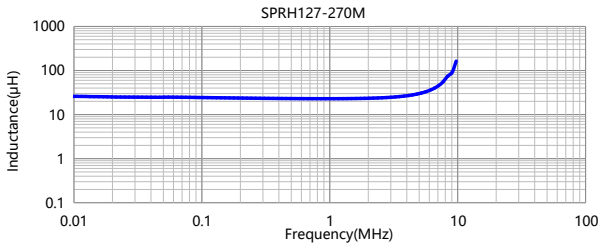
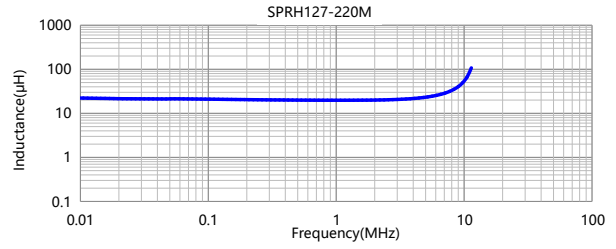
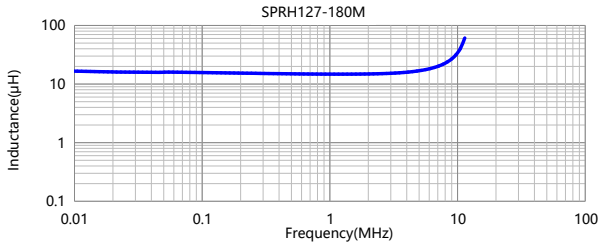



SMD Power Inductor SPRH127 Series

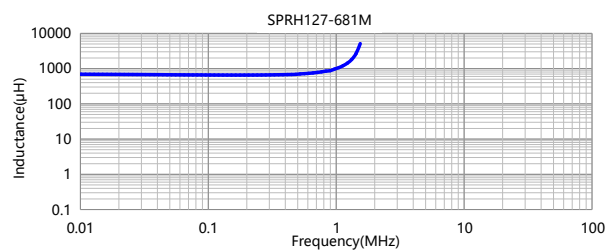
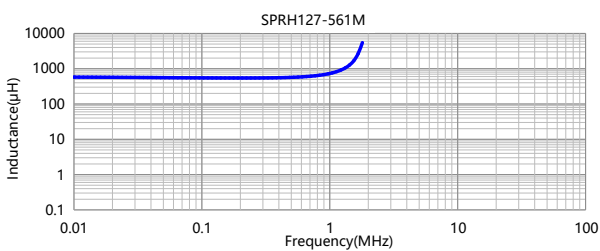
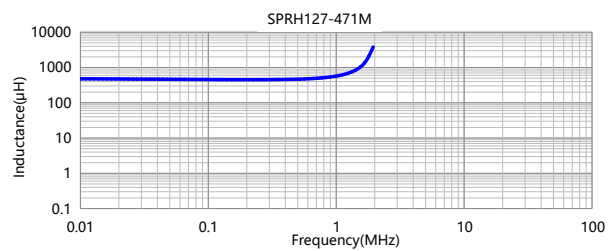
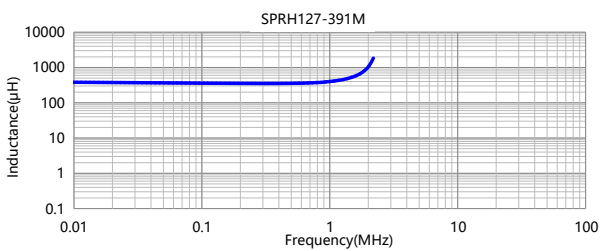
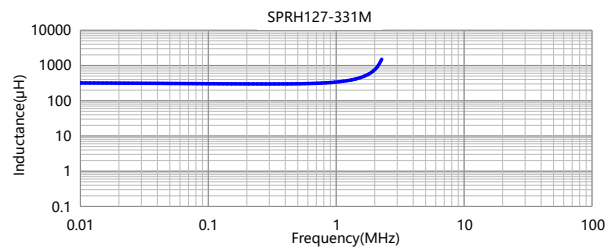
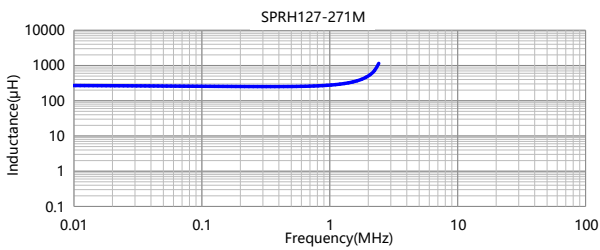
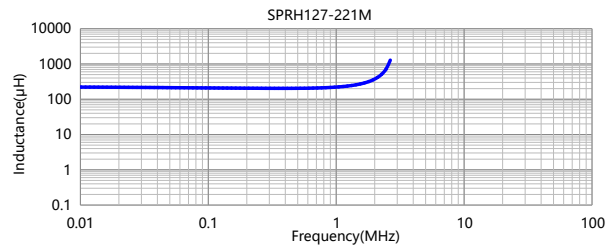
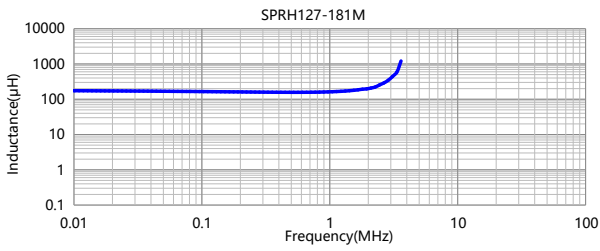
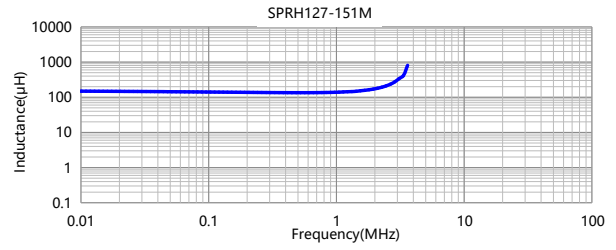
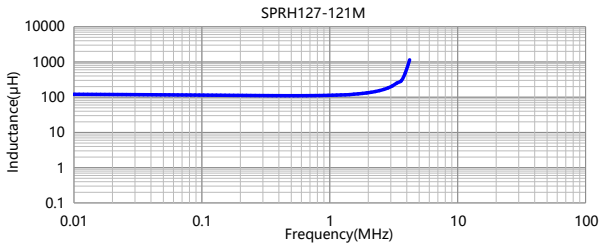



SMD Power Inductor SPRH127 Series

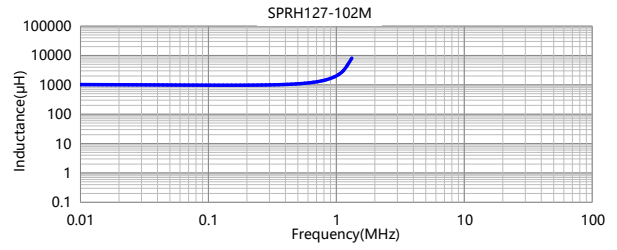
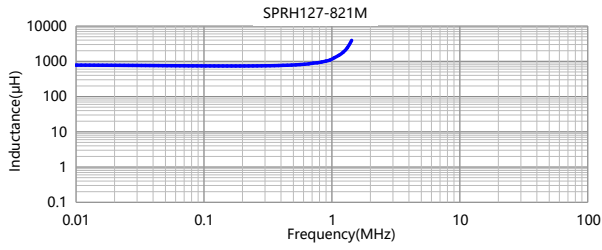

5 Impedance vs Frequency

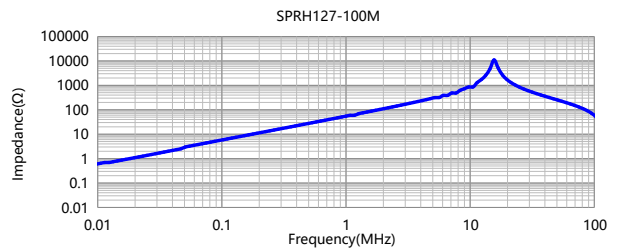
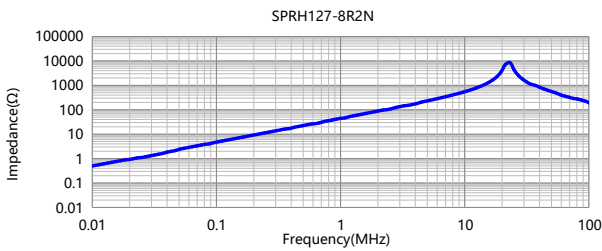
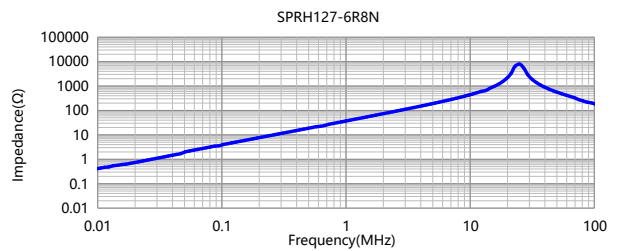
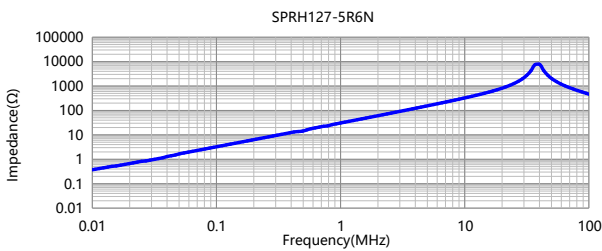
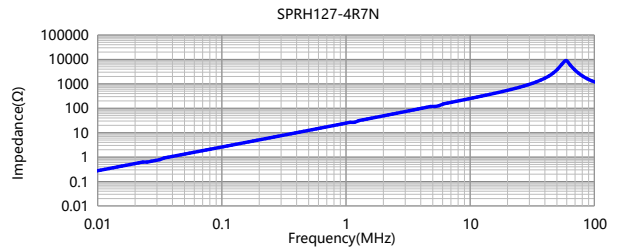
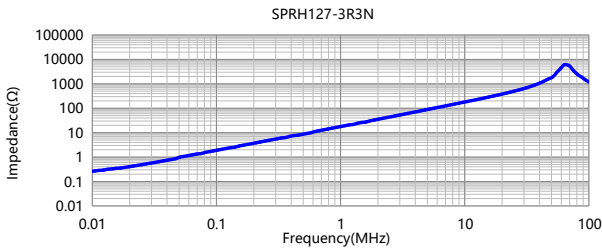
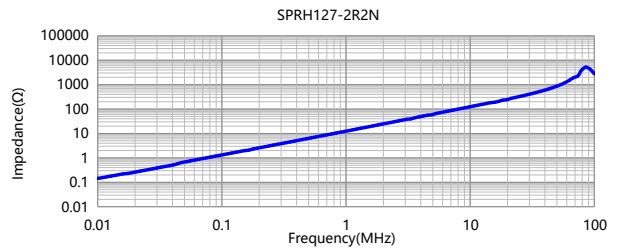
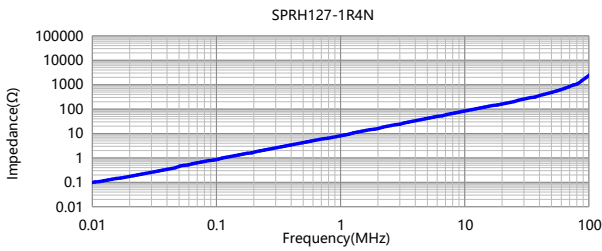



SMD Power Inductor SPRH127 Series

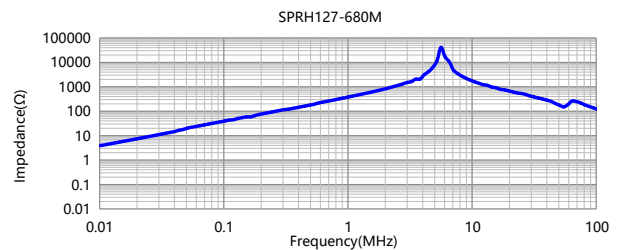
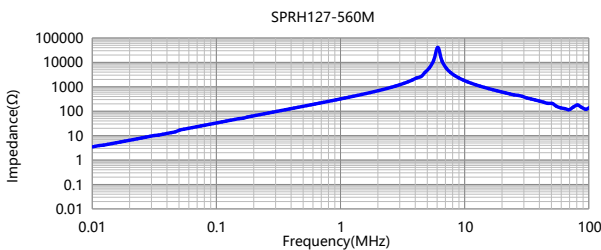
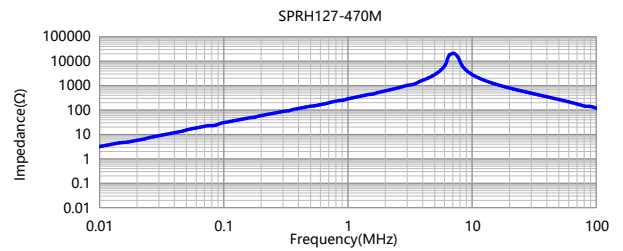
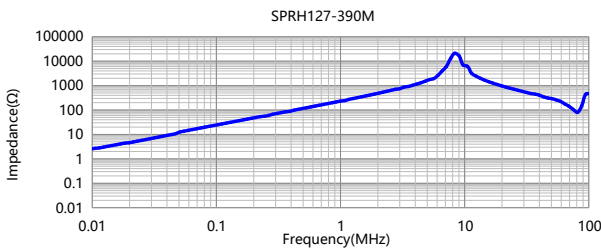
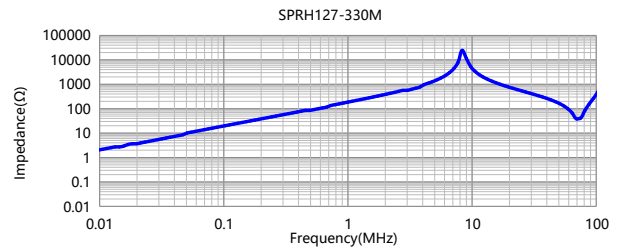
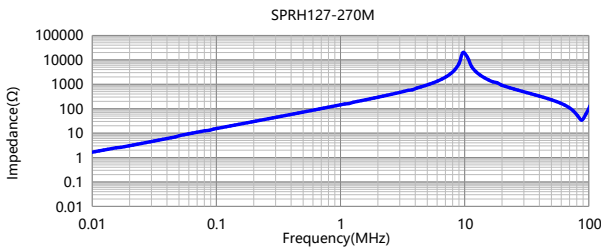
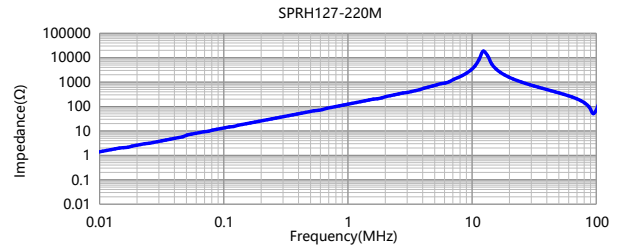
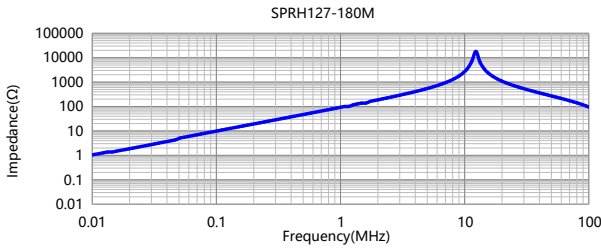
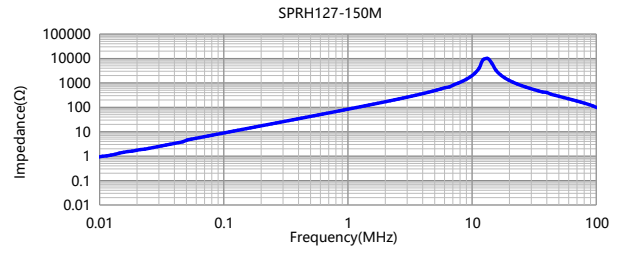
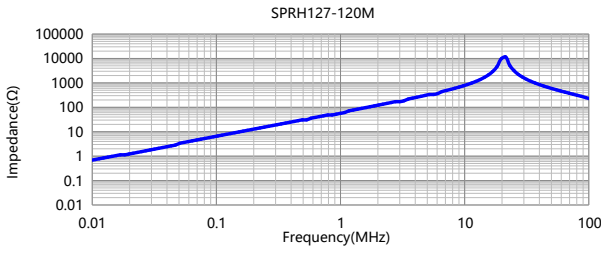



SMD Power Inductor SPRH127 Series

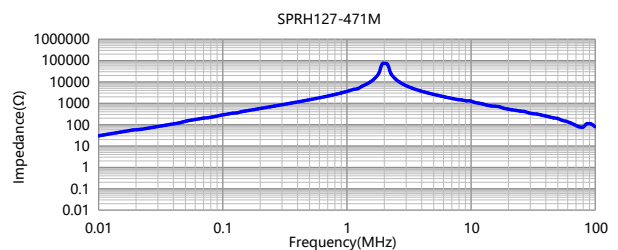
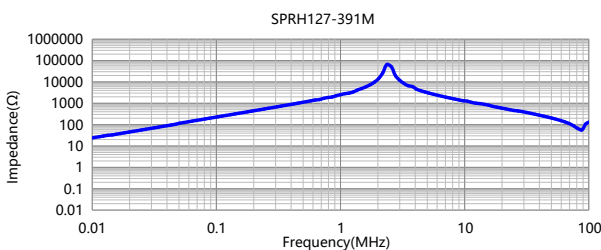
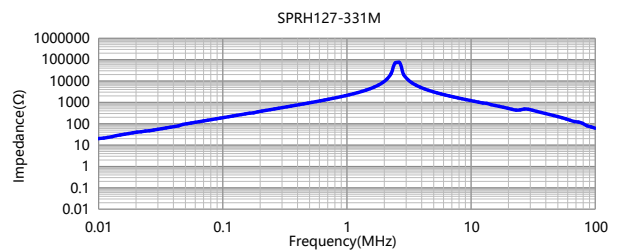
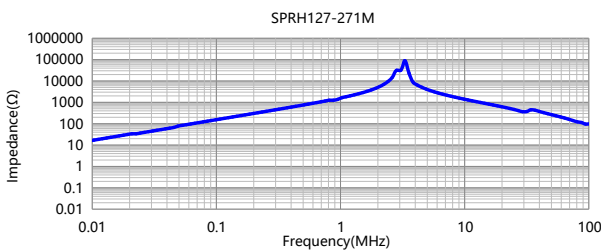
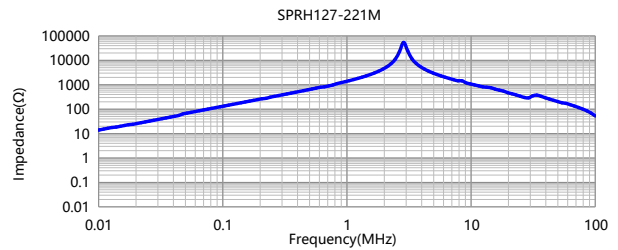
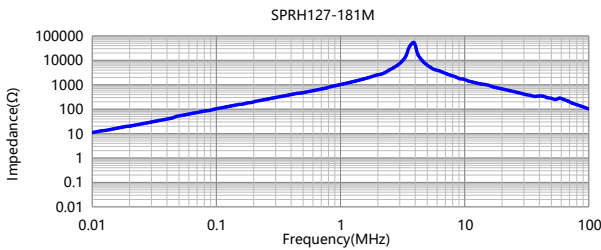
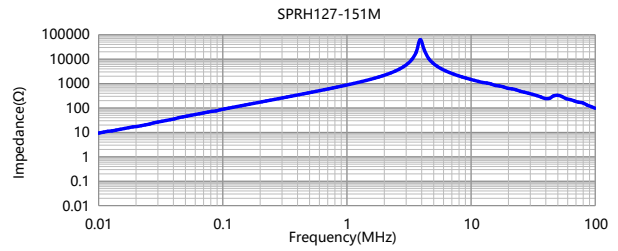
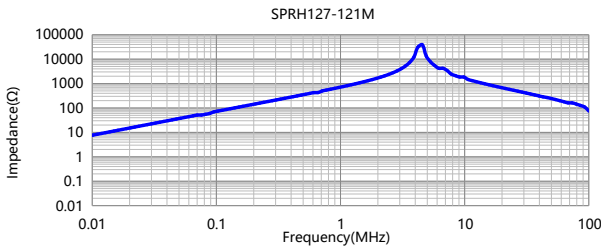
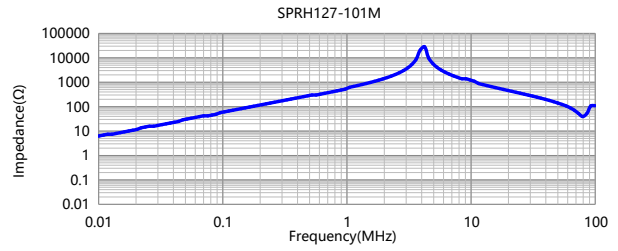
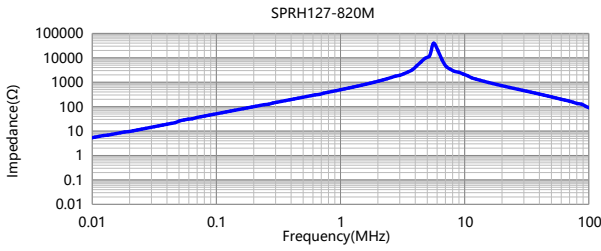



SMD Power Inductor SPRH127 Series

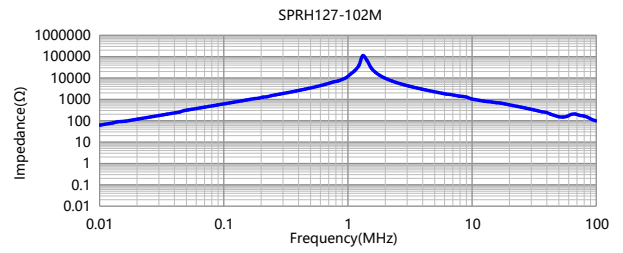
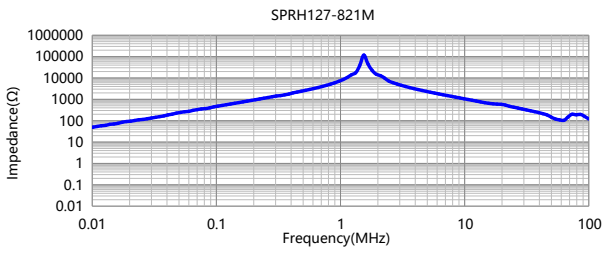
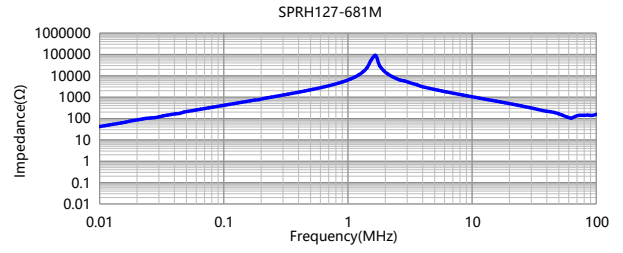
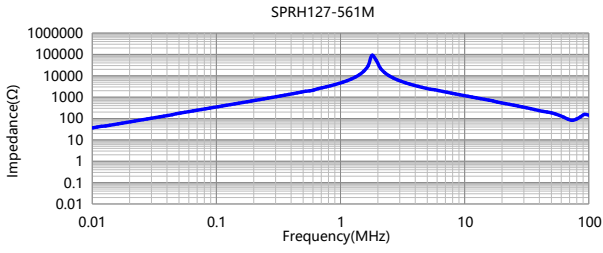

6 Packing Specification

6.1 Carrier Tape Dimensions (mm)

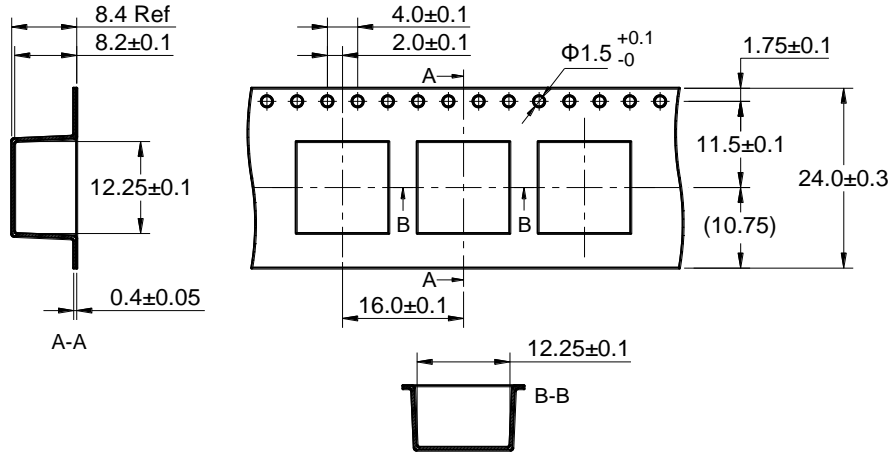

※ Packing is referred to the international standard IEC 60286-3.

6.2 Reel Dimensions (mm)

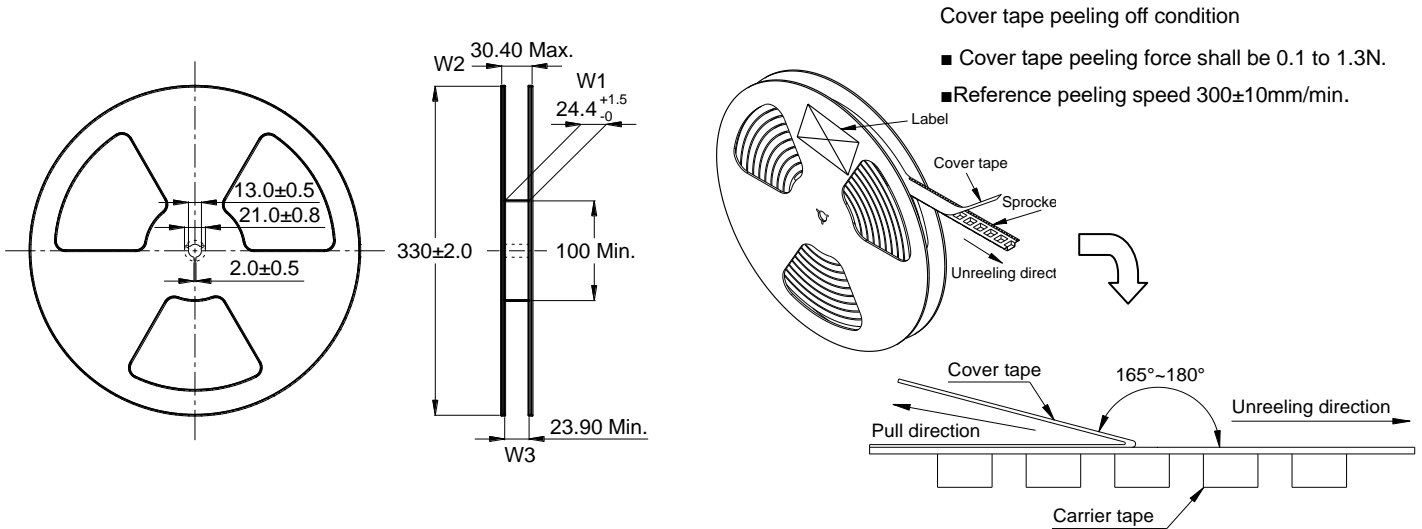

6.3 Carton Dimensions and Packing Quantity

■ Inner Carton : 340×340×95mm

■ Out Carton : 385×365×245mm

Product Series	Quantity / Reel	Inner Carton Quantity	Out Carton Quantity
SPRH127	500pcs	(500×3) = 1500pcs	(1500×2) = 3000pcs

7 Soldering Specification

7.1 Reflow Profile for SMT Components

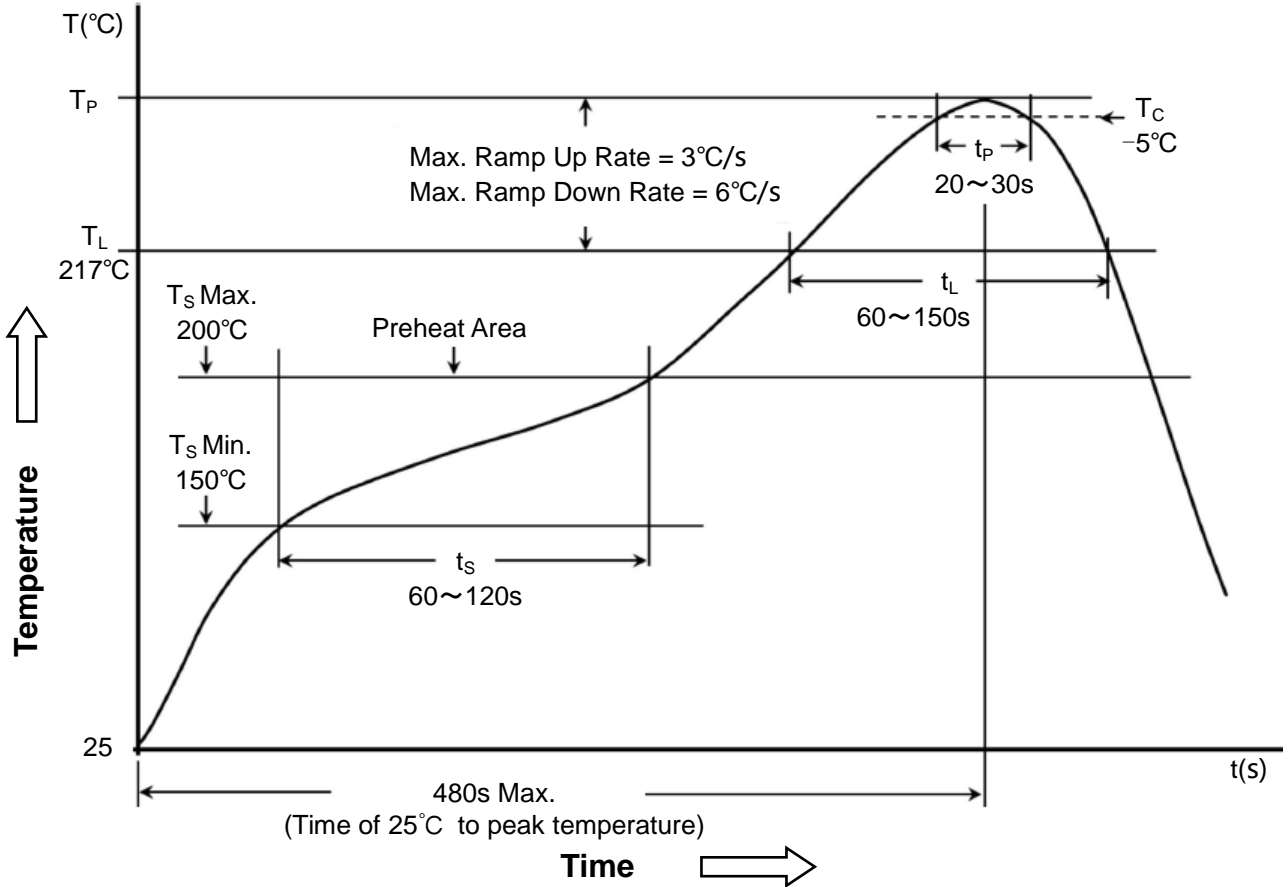

7.2 Classification of Peak Package Body Temperature (Tp)

	Package Thickness	Package Volume		
		<350 mm ³	350 ~ 2000 mm ³	>2000 mm ³
PB-Free Assembly	<1.6mm	260°C	260°C	260°C
	1.6 ~ 2.5mm	260°C	250°C	245°C
	≥2.5mm	250°C	245°C	245°C

※ Reflow is referred to standard IPC/JEDEC J-STD-020E.

8 Notice of Use

- 8.1 Special remind:Circuit design, component placement, PCB size and thickness, cooling system and etc. all will affect the product temperature. Please verify the product temperature in the final application.
- 8.2 Product in packing storage condition:temperature 5 ~ 40°C, RH≤ 70%.
If taking out for use, the remaining products should be sealed in plastic bags and preserved in accordance with the above conditions, to avoid oxidation of terminals (electrodes), affecting soldering status.
- 8.3 A storage of Codaca Electronic products for longer than 12 months is not recommended, Within other effects, the terminals may suffer degradation, resulting in bad solderability. Therefore, all products shall be used within the period of 12 months based on the day of shipment.
- 8.4 Do not keep products in unsuitable storage conditions, such as areas susceptible to high temperatures, high humidity, dust or corrosion.
- 8.5 Always handle products with care.
- 8.6 Don't touch electrodes directly with bare hands as oil secretions may inhibit soldering.
Always ensure optimum conditions for soldering.
- 8.7 When this product will be used on a similar or new project to the original one,
sometimes it might be unable to satisfy the specifications due to different condition of usage.
- 8.8 This inductor itself does not have any protective function in abnormal condition, such as overload, short-circuit, open-circuit conditions, etc. Therefore, it shall be confirmed that there is no risk of smoke, fire, dielectric withstand voltage, insulation resistance, etc., or use in abnormal conditions protective devices or protection circuit in the end product.
- 8.9 Hi-Pot test with higher voltage than spec value will damage insulating material and shorten its life.
- 8.10 If using in potting compound, the magnet wire coating might be damaged, please consult with us.
- 8.11 Refrain from rinsing coils. If necessary, please consult with us.
- * 8.12 Codaca Electronic products without "V" prefix are qualified for industrial product requirement , and with "V" prefix are qualified for AEC-Q200, but it doesn't mean that Codaca Electronic products can absolutely meet specific industry norms and quality test standards in automotive electronics or more strict application fields . Codaca Electronic will be exempted from being responsible for the consequences of using Codaca products in automotive electronic or higher application field related to safety when without being aware of it.

OUR CERTIFICATE

DiGi provide top-quality products and perfect service for customer worldwide through standardization, technological innovation and continuous improvement. DiGi through third-party certification, we stricly control the quality of products and services. Welcome your RFQ to

Email: Info@DiGi-Electronics.com



Tel: +00 852-30501935

RFQ Email: Info@DiGi-Electronics.com

DiGi is a global authorized distributor of electronic components.