

ABC857AW-HF Datasheet



<https://www.DiGi-Electronics.com>

DiGi Electronics Part Number	ABC857AW-HF-DG
Manufacturer	Comchip Technology
Manufacturer Product Number	ABC857AW-HF
Description	TRANS PNP 45V 0.1A SOT323
Detailed Description	Bipolar (BJT) Transistor PNP 45 V 100 mA 250MHz 200 mW Surface Mount SOT-323



Tel: +00 852-30501935

RFQ Email: Info@DiGi-Electronics.com

DiGi is a global authorized distributor of electronic components.

Purchase and inquiry

Manufacturer Product Number:

ABC857AW-HF

Series:

-

Transistor Type:

PNP

Voltage - Collector Emitter Breakdown (Max):

45 V

Current - Collector Cutoff (Max):

15nA (ICBO)

Power - Max:

200 mW

Operating Temperature:

-65°C ~ 150°C (TJ)

Package / Case:

SC-70, SOT-323

Base Product Number:

ABC857

Manufacturer:

Comchip Technology

Product Status:

Active

Current - Collector (Ic) (Max):

100 mA

Vce Saturation (Max) @ Ib, Ic:

650mV @ 5mA, 100mA

DC Current Gain (hFE) (Min) @ Ic, Vce:

125 @ 2mA, 5V

Frequency - Transition:

250MHz

Mounting Type:

Surface Mount

Supplier Device Package:

SOT-323

Environmental & Export classification

RoHS Status:

ROHS3 Compliant

ECCN:

EAR99

Moisture Sensitivity Level (MSL):

1 (Unlimited)

HTSUS:

8541.21.0075

General Purpose Transistor



ABC856AW-HF Thru. ABC858CW-HF (PNP)

RoHS Device

Halogen Free

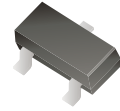

Features

- For AF input stages and driver applications.
- High current gain.
- Low collector-emitter saturation voltage.
- Low noise between 30Hz and 15kHz.
- AEC-Q101 Qualified.

Mechanical data

- Case: SOT-323, molded plastic.

Circuit Diagram

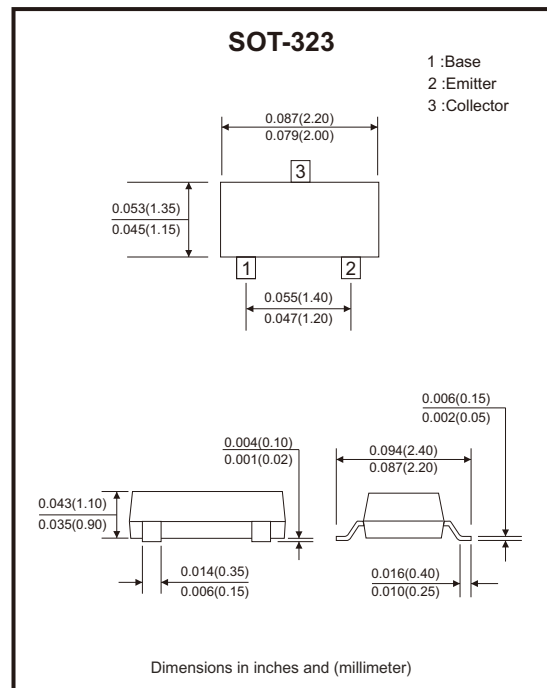
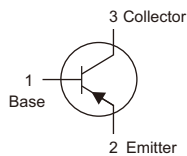

Maximum Ratings (Ta=25°C unless otherwise noted)

Parameter	Symbol	Value	Unit
Collector-base voltage	V_{CBO}	-80 -50 -30	V
Collector-emitter voltage	V_{CEO}	-65 -45 -30	V
Emitter-base voltage	V_{EBO}	-5	V
Collector current-continuous	I_C	-100	mA
Peak collector current	I_{CM}	-200	mA
Peak base current	I_{BM}	-200	mA
Collector dissipation	P_C	200	mW
Junction and storage temperature range	T_J, T_{STG}	-65 to +150	°C

Company reserves the right to improve product design , functions and reliability without notice.

REV:A

General Purpose Transistor

Electrical Characteristics (Ta= 25°C unless otherwise specified)

Parameter	Symbol	Test Conditions	Min.	Typ.	Max.	Unit
Collector-base breakdown voltage	$V_{(BR)CBO}$	$I_C = -10\mu A, I_E = 0$	-80 -50 -30			V
Collector-emitter breakdown voltage	$V_{(BR)CEO}$	$I_C = -10mA, I_B = 0$	-65 -45 -30			V
Emitter-base breakdown voltage	$V_{(BR)EBO}$	$I_E = -1\mu A, I_C = 0$	-5			V
Collector cut-off current	I_{CBO}	$V_{CB} = -30V, I_E = 0$			-15	nA
Emitter cut-off current	I_{EBO}	$V_{EB} = -5V, I_C = 0$			-0.1	μA
DC current gain	h_{FE}	$V_{CE} = -5V, I_C = -10\mu A$		140 250 480		
DC current gain	h_{FE}	$V_{CE} = -5V, I_C = -2mA$	125 220 420	180 290 520	250 475 800	
Collector-emitter saturation voltage	$V_{CE(sat)}$	$I_C = -10mA, I_B = -0.5mA$ $I_C = -100mA, I_B = -5mA$		-0.075 -0.25	-0.3 -0.65	V
Base-emitter saturation voltage	$V_{BE(sat)}$	$I_C = -10mA, I_B = -0.5mA$ $I_C = -100mA, I_B = -5mA$		-0.7 -0.85		V
Base-emitter voltage	$V_{BE(on)}$	$I_C = -2mA, V_{CE} = 5V$ $I_C = -10mA, V_{CE} = 5V$	-0.6 -		-0.75 -0.82	V
Transition frequency	f_T	$V_{CE} = -5V, I_C = -20mA, f = 100MHz$		250		MHz
Collector-base capacitance	C_{cb}	$V_{CB} = -10V, f = 1MHz$		3	5	pF
Emitter-base capacitance	C_{eb}	$V_{EB} = -0.5V, f = 1MHz$		10	15	pF

Rating and Characteristic Curves (ABC856AW-HF Thru. ABC858CW-HF)

Fig.1 - Total Power Dissipation

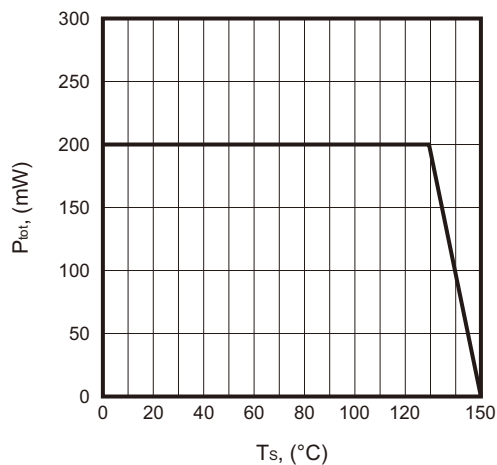
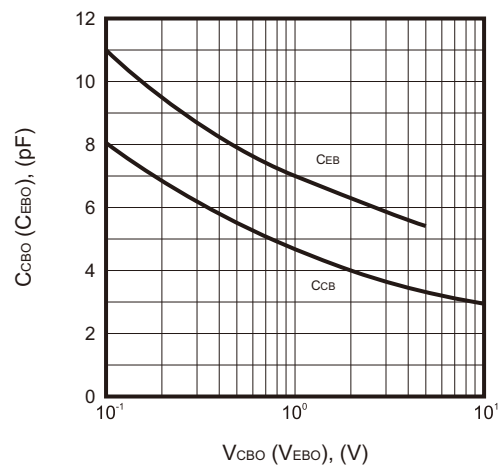

Fig.2 - Collector-Base Capacitance
Emitter-Base Capacitance



Company reserves the right to improve product design, functions and reliability without notice.

REV:A

General Purpose Transistor



Rating and Characteristic Curves (ABC856AW-HF Thru. ABC858CW-HF)

Fig.3 - Transition Frequency

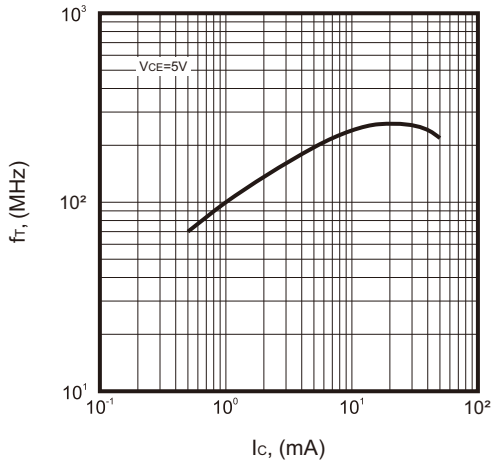

Fig.4 - Collector Cutoff Current

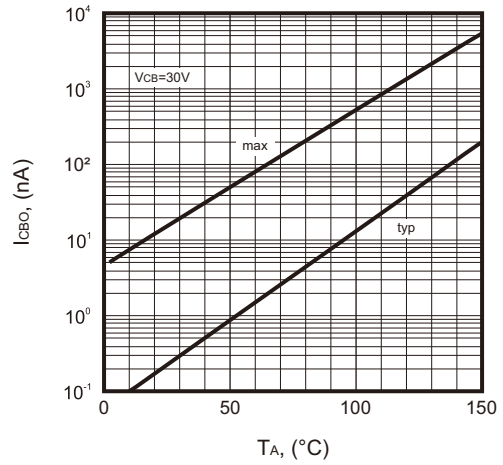

Fig.5 - Collector-Emitter Saturation Voltage

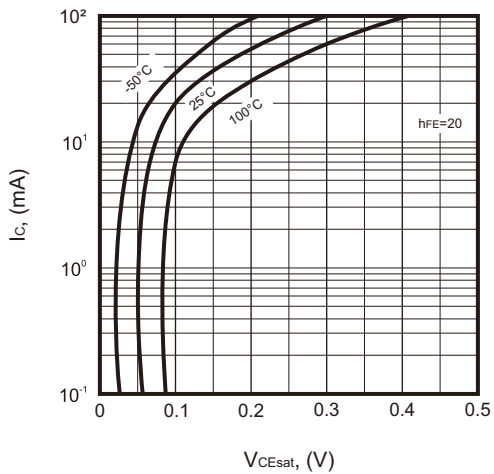

Fig.6 - DC Current Gain

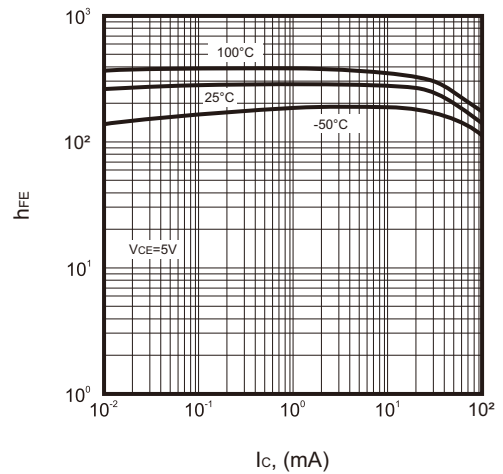
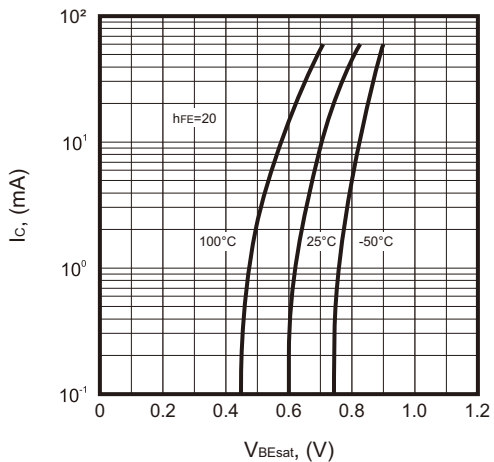

Fig.7 - Base-Emitter Saturation Voltage



Company reserves the right to improve product design, functions and reliability without notice.

REV:A

General Purpose Transistor



Reel Taping Specification

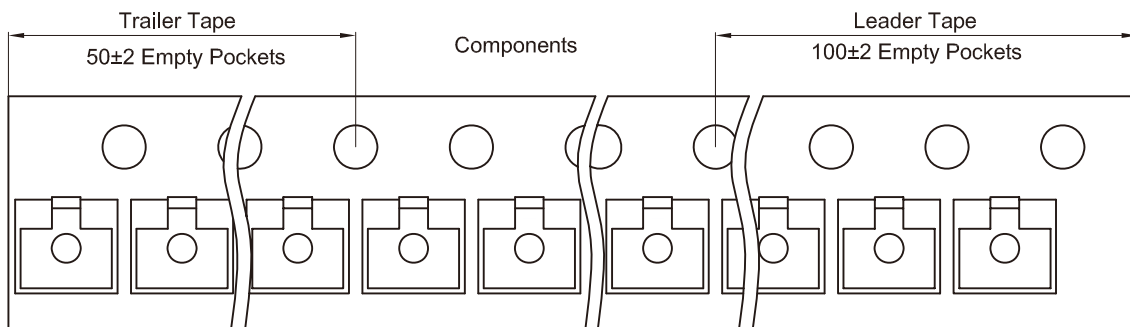
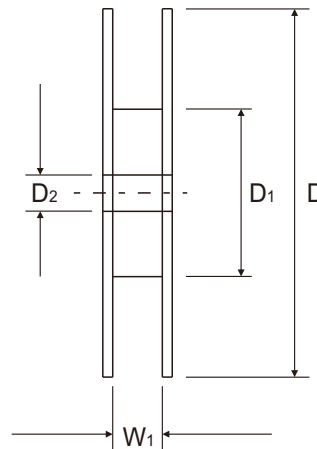
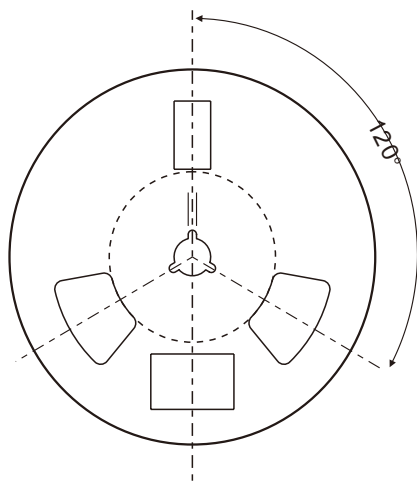
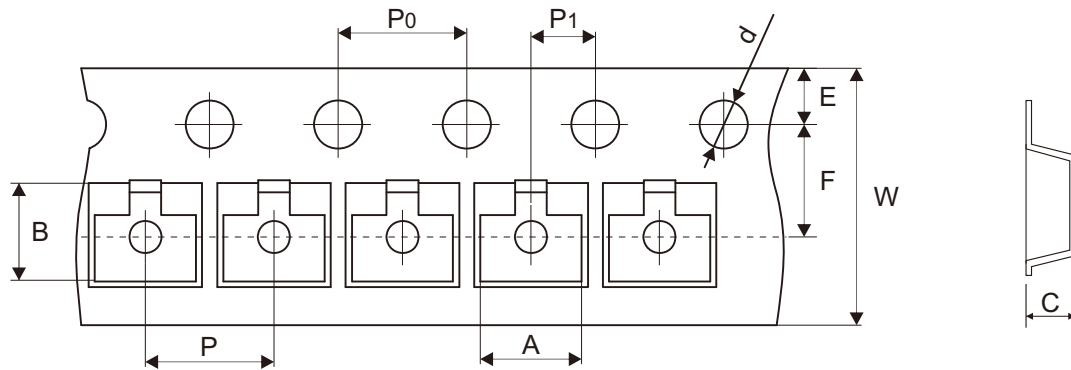

SOT-323	SYMBOL	A	B	C	d	D	D1	D2
	(mm)	2.25 ± 0.10	2.55 ± 0.10	1.20 ± 0.10	1.50 ± 0.10	178.00 ± 1.00	54.00 ± 0.50	13.00 ± 0.50
	(inch)	0.089 ± 0.004	0.100 ± 0.004	0.047 ± 0.004	0.059 ± 0.004	7.008 ± 0.039	2.126 ± 0.020	0.512 ± 0.020

SOT-323	SYMBOL	E	F	P	P0	P1	W	W1
	(mm)	1.75 ± 0.10	3.50 ± 0.05	4.00 ± 0.10	4.00 ± 0.10	2.00 ± 0.05	8.00 + 0.30 - 0.10	9.50 ± 1.00
	(inch)	0.069 ± 0.004	0.138 ± 0.002	0.157 ± 0.004	0.157 ± 0.004	0.079 ± 0.002	0.315 + 0.012 - 0.004	0.374 ± 0.039

Company reserves the right to improve product design, functions and reliability without notice.

REV:A

General Purpose Transistor



Marking Code

Part Number	Marking Code
ABC856AW-HF	3A
ABC857AW-HF	3E
ABC858AW-HF	3J
ABC856BW-HF	3B
ABC857BW-HF	3F
ABC858BW-HF	3K
ABC857CW-HF	3G
ABC858CW-HF	3L

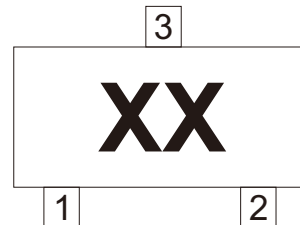

xx = Product type marking code

Suggested P.C.B. PAD Layout

SIZE	SOT-323	
	(mm)	(inch)
A	0.90	0.035
B	0.70	0.028
C	1.30	0.051
D	1.90	0.075

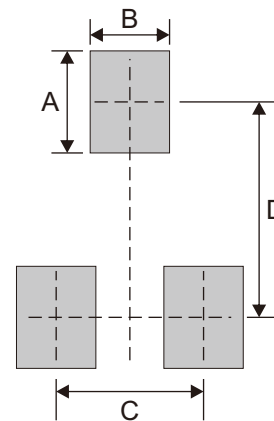

Note: 1. The pad layout is for reference purposes only.

Standard Packaging

Case Type	REEL PACK	
	REEL (pcs)	Reel Size (inch)
SOT-323	3,000	7

Company reserves the right to improve product design , functions and reliability without notice.

REV:A

OUR CERTIFICATE

DiGi provide top-quality products and perfect service for customer worldwide through standardization, technological innovation and continuous improvement. DiGi through third-party certification, we stricly control the quality of products and services. Welcome your RFQ to

Email: Info@DiGi-Electronics.com



Tel: +00 852-30501935

RFQ Email: Info@DiGi-Electronics.com

DiGi is a global authorized distributor of electronic components.