

# CLM1C-WKW-CVBWB453 Datasheet

[www.digi-electronics.com](http://www.digi-electronics.com)



<https://www.DiGi-Electronics.com>

DiGi Electronics Part Number	CLM1C-WKW-CVBWB453-DG
Manufacturer	<a href="#">CreeLED, Inc.</a>
Manufacturer Product Number	CLM1C-WKW-CVBWB453
Description	LED COOL WHITE DIFF 2PLCC SMD
Detailed Description	White, Cool 6800K LED Indication - Discrete 3.2V 2-PLCC

This model CLM1C-WKW-CVBWB453 is available at DiGi Electronics.

DiGi Electronics offers a global database of semiconductor and electronic component datasheets.

We welcome your inquiries regarding pricing, lead time, or other product-related questions.

 [Request a Quote](#)

 [Datasheet Search](#)



Tel: +00 852-30501935

RFQ Email: [Info@DiGi-Electronics.com](mailto:Info@DiGi-Electronics.com)

DiGi is a global authorized distributor of electronic components.

## Purchase and inquiry

Manufacturer Product Number:

CLM1C-WKW-CVBWB453

Series:

CLM1C

Color:

White, Cool

Lens Color:

Yellow

Millicandela Rating:

1350mcd

Lens Size:

-

Current - Test:

20mA

Mounting Type:

Surface Mount

Wavelength - Peak:

-

Package / Case:

2-PLCC

Size / Dimension:

3.20mm L x 2.80mm W

Base Product Number:

CLM1C

Manufacturer:

CreeLED, Inc.

Product Status:

Obsolete

Configuration:

Standard

Lens Transparency:

Diffused

Lens Style:

Round with Flat Top

Voltage - Forward (Vf) (Typ):

3.2V

Viewing Angle:

120°

Wavelength - Dominant:

6800K

Features:

-

Supplier Device Package:

2-PLCC

Height (Max):

2.05mm

## Environmental & Export classification

Moisture Sensitivity Level (MSL):

5A (24 Hours)

ECCN:

EAR99

REACH Status:

REACH Unaffected

HTSUS:

8541.41.0000

## CLM1C-WKW: PLCC2 1 IN 1 SMD LED

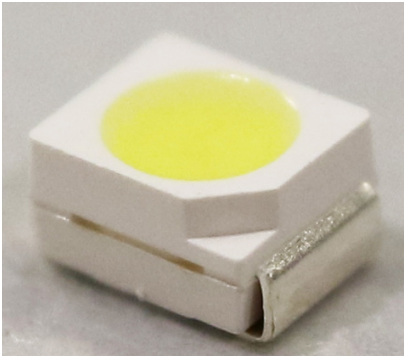

### PRODUCT DESCRIPTION

SMD LEDs is packaged in the industry standard package. These LEDs have high reliability performance and are designed to work under a wide range of environmental conditions.

This high reliability feature makes them ideally suited to be used under illumination application conditions.

Its wide viewing angle makes these LEDs ideally suited for channel letter, or general backlighting and illumination applications. The flat top emitting surface makes it easy for these LEDs to mate with light pipes.

### FEATURES

- Size (mm): 3.2 X 2.8
- Color Temperatures:  
Cool White :  
Min . (4600K) / Typical (6800K)
- Luminous Intensity (mcd)  
CLM1C-WKW:(1400-2800)
- Moisture Sensitivity Level: 5a
- Lead - Free
- RoHS Compliant

### APPLICATIONS

- Channel Letter

### ABSOLUTE MAXIMUM RATINGS ( $T_A = 25^\circ\text{C}$ )

Items	Symbol	Absolute Maximum Rating	Unit
Forward Current	$I_F$	25	mA
Peak Forward Current <sup>Note 1</sup>	$I_{FP}$	100	mA
Reverse Voltage	$V_R$	5	V
Power Dissipation	$P_D$	100	mW
Operation Temperature	$T_{opr}$	-40 ~ +100	$^\circ\text{C}$
Storage Temperature	$T_{stg}$	-40 ~ +100	$^\circ\text{C}$
Junction Temperature	$T_J$	110	$^\circ\text{C}$
Junction/Ambient	$R_{THJA}$	450	$^\circ\text{C/W}$
Junction/Solder Point	$R_{THJS}$	300	$^\circ\text{C/W}$

#### Note:

1. Pulse width  $\leq 0.1$  msec, duty  $\leq 1/10$ .

### TYPICAL ELECTRICAL & OPTICAL CHARACTERISTICS ( $T_A = 25^\circ\text{C}$ )

Characteristics	Symbol	Condition	Unit	Minimum	Typical	Maximum
Forward Voltage	$V_F$	$I_F = 20$ mA	V		3.1	4.0
Reverse Current	$I_R$	$V_R = 5$ V	$\mu\text{A}$			10
Luminous Intensity	$I_V$	$I_F = 20$ mA	mcd	1400	2100	
Chromaticity Coordinates	x	$I_F = 20$ mA			0.3100	
	y	$I_F = 20$ mA			0.3200	

- \* Continuous reverse voltage can cause LED damage.

## INTENSITY BIN LIMIT

Cool White (20 mA) - CLM1C-WKW		
Bin Code	Min.(mcd)	Max.(mcd)
Wb	1400	1800
Xa	1800	2240
Xb	2240	2800

\* Tolerance of measurement of luminous intensity is  $\pm 10\%$

## VOLTAGE BIN LIMIT

Cool White (20 mA) - CLM1C-WKW		
Bin Code	Min. (V)	Max. (V)
27	2.8	3.0
28	3.0	3.2
29	3.2	3.4
2a	3.4	3.6
2b	3.6	3.8
2c	3.8	4.0

\* Tolerance of measurement of voltage is  $\pm 0.05V$

## COLOR BIN LIMIT

### Cool White (20 mA) - CLM1C-WKW

Bin Code	Sub-bin	x	y
W1	Wa	0.2545	0.2480
		0.2633	0.2410
		0.2545	0.2245
		0.2450	0.2290
	Wb	0.2633	0.2410
		0.2720	0.2340
		0.2640	0.2200
		0.2545	0.2245
	Wc	0.2545	0.2480
		0.2640	0.2670
		0.2720	0.2575
		0.2633	0.2410
	Wd	0.2633	0.2410
		0.2720	0.2575
		0.2800	0.2480
		0.2720	0.2340
W2	We	0.2640	0.2670
		0.2735	0.2860
		0.2808	0.2740
		0.2720	0.2575
	Wf	0.2720	0.2575
		0.2808	0.2740
		0.2880	0.2620
		0.2800	0.2480
	Wg	0.2735	0.2860
		0.2830	0.3050
		0.2895	0.2905
		0.2808	0.2740
	Wh	0.2808	0.2740
		0.2895	0.2905
		0.2960	0.2760
		0.2880	0.2620

Bin Code	Sub-bin	x	y
W3	Wj	0.2830	0.3050
		0.2950	0.3210
		0.2998	0.3028
		0.2895	0.2905
	Wk	0.2895	0.2905
		0.2998	0.3028
		0.3045	0.2865
		0.2960	0.2760
	Wm	0.2950	0.3210
		0.3070	0.3370
		0.3100	0.3150
		0.2998	0.3028
	Wn	0.2998	0.3028
		0.3100	0.3150
		0.3130	0.2970
		0.3045	0.2865
W4	Wp	0.3070	0.3370
		0.3185	0.3485
		0.3200	0.3270
		0.3100	0.3150
	Wq	0.3100	0.3150
		0.3200	0.3270
		0.3215	0.3075
		0.3130	0.2970
	Wr	0.3185	0.3485
		0.3300	0.3600
		0.3300	0.3390
		0.3200	0.3270
	Ws	0.3200	0.3270
		0.3300	0.3390
		0.3300	0.3180
		0.3215	0.3075

Bin Code	Sub-bin	x	y
W5	Wt	0.3300	0.3600
		0.3455	0.3725
		0.3443	0.3535
		0.3300	0.3390
	Wu	0.3300	0.3390
		0.3443	0.3535
		0.3430	0.3345
		0.3300	0.3180
	Wv	0.3455	0.3725
		0.3610	0.3850
		0.3585	0.3680
		0.3443	0.3535
	Ww	0.3443	0.3535
		0.3585	0.3680
		0.3560	0.3510
		0.3430	0.3345

\* Tolerance of measurement of the color coordinates is  $\pm 0.01$



## ORDER CODE TABLE

Color	Kit Number	Luminous Intensity (mcd)		Color Bin Code
		Min.	Max.	
Cool White	CLM1C-WKW-CWbXb153	1400	2800	W1,W2,W3,W4,W5
	CLM1C-WKW-CWbXb233	1400	2800	W2,W3
	CLM1C-WKW-CWbXb453	1400	2800	W4,W5
	CLM1C-WKW-CXaXb153	1800	2800	W1,W2,W3,W4,W5
	CLM1C-WKW-CXaXb233	1800	2800	W2,W3
	CLM1C-WKW-CXaXb453	1800	2800	W4,W5

### Notes:

- The above kit numbers represent order codes that include multiple intensity-bin and color-bin codes. Only one intensity-bin code and one color-bin code will be shipped on each bulk. Single intensity-bin code and single color-bin codes will not be orderable.
- Please refer to the [HB LED Lamp Reliability Test Standards](#) document for reliability test conditions.
- Please refer to the [HB LED Lamp Soldering & Handling](#) document for information about how to use this LED product safely.

## GRAPHS

The data below are collected from statistical figures that do not necessarily correspond to the actual parameters of each single LED. Hence, these data will be changed without further notice.

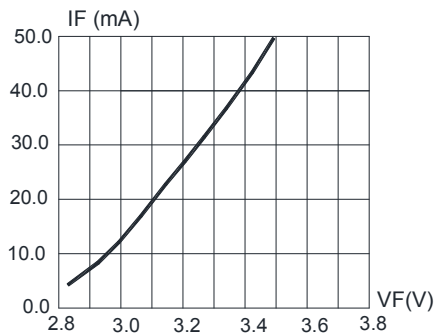

FIG.1 FORWARD CURRENT VS. FORWARD VOLTAGE.

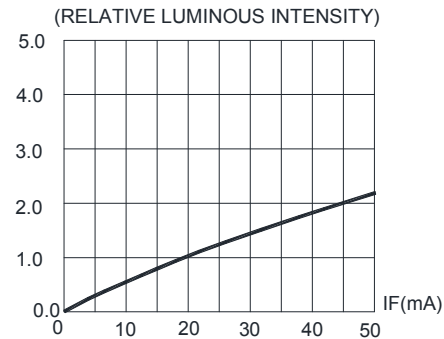

FIG.2 RELATIVE LUMINOUS INTENSITY VS. FORWARD CURRENT

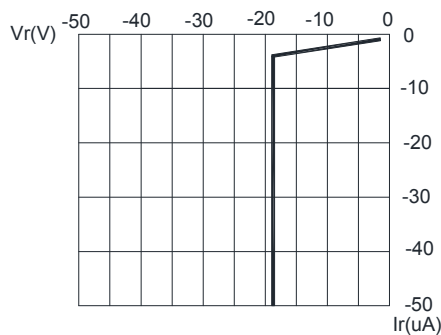

FIG.3 REVERSE CURRENT VS. REVERSE VOLTAGE.

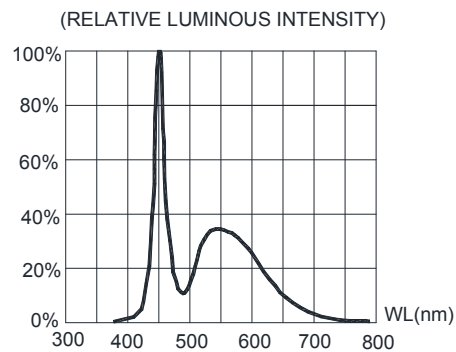

FIG.4 RELATIVE LUMINOUS INTENSITY VS. WAVELENGTH.

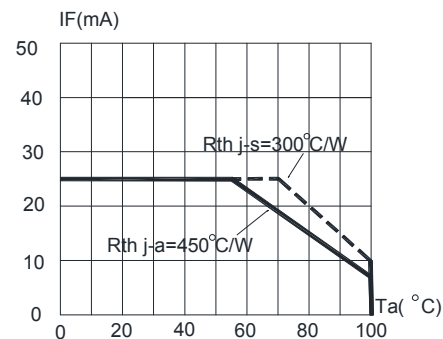

FIG.5 MAXIMUM FORWARD DC CURRENT VS AMBIENT TEMPERATURE ( $T_{jmax}=110^{\circ}\text{C}$ )

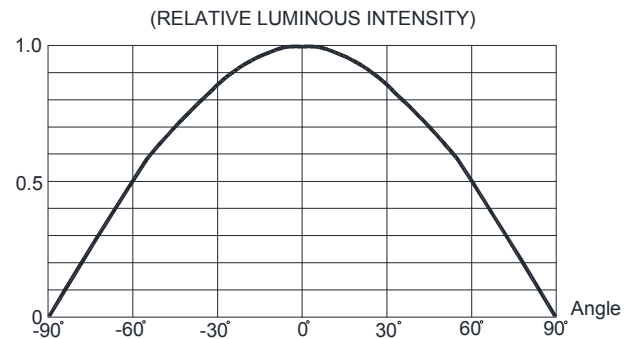
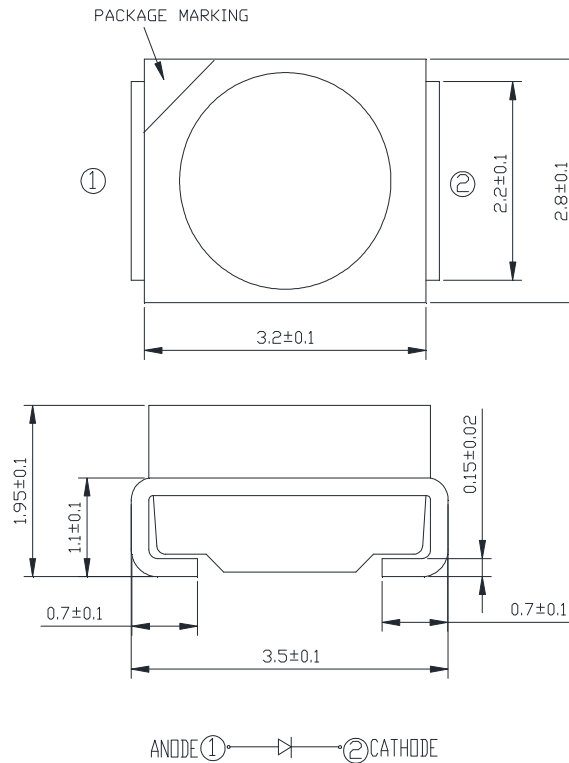

FIG.6 FAR FIELD PATTERN

## MECHANICAL DIMENSIONS

All dimensions are in mm.



## NOTES

### RoHS Compliance

The levels of RoHS restricted materials in this product are below the maximum concentration values (also referred to as the threshold limits) permitted for such substances, or are used in an exempted application, in accordance with EU Directive 2011/65/EC (RoHS2), as implemented January 2, 2013. RoHS Declarations for this product can be obtained from your Cree LED representative or from the [Product Ecology](#) section of the Cree LED website.

### Vision Advisory

WARNING: Do not look at an exposed lamp in operation. Eye injury can result.

## KIT NUMBER SYSTEM

Cree LED lamps are tested and sorted into performance bins. A bin is specified by ranges of color, forward voltage, and brightness. Sorted LEDs are packaged for shipping in various convenient options.

Cree LEDs are sold by order codes in combinations of bins called kits. Order codes are configured in the following manner:

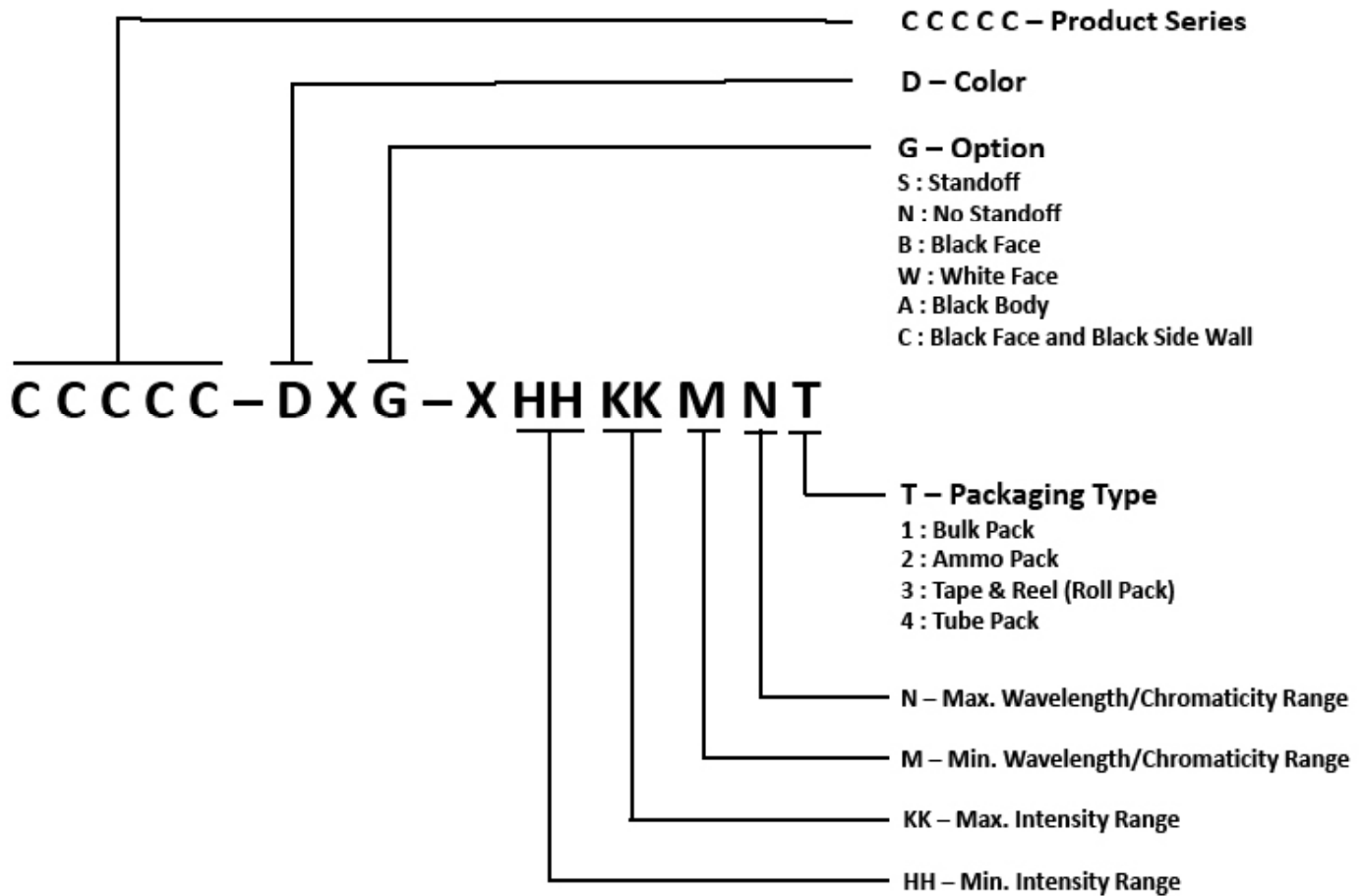

## REFLOW SOLDERING

- The CLM1C-WKW is rated as a MSL 5a product.
- The recommended floor life out of bag is 24hrs.
- The temperature profile is as below.

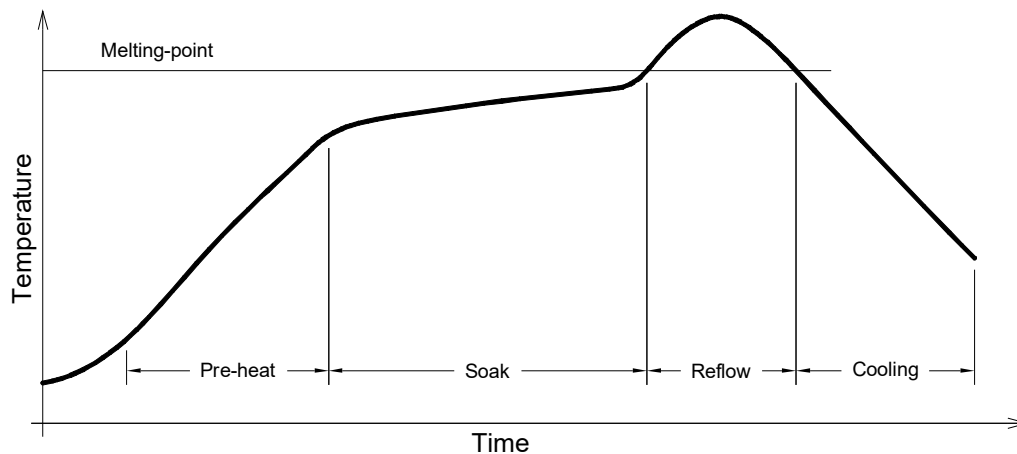

Use only with CLM1C-WKW

Solder
Average ramp-up rate = 4 °C/second max.
Soak temperature = 150°C-200°C
Soak time = 120 seconds max.
Duration above 217 °C = 60 seconds max.
Peak temperature = 250°C max
Time within 5 °C of peak temperature = 10 seconds max.
Ramp-down rate = 6 °C/second max.

- The packaging sizes of these SMD products are very small and the resin is still soft after solidification. Users are required to handle with care. Never touch the resin surface of SMD products.
- To avoid damaging the product's surface and interior device, it is recommended to choose a special nozzle to pick up the SMD products during the process of SMT production. If handling is necessary, take special care when picking up these products. The following method is necessary:
- Please refer to the [HB LED Lamp Soldering & Handling](#) document for information about how to use this LED product safely.

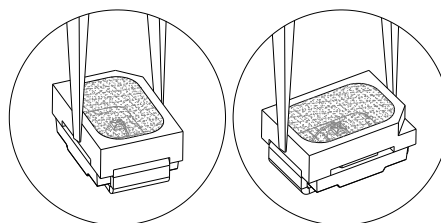

## PACKAGING

- The LEDs are packed in cardboard boxes after packaging in normal or anti-electrostatic bags.
- Cardboard boxes will be used to protect the LEDs from mechanical shock during transportation.
- The boxes are not water resistant, and they must be kept away from water and moisture.
- The reel pack is applied in SMD LED.
- Max 2000 pcs per reel.

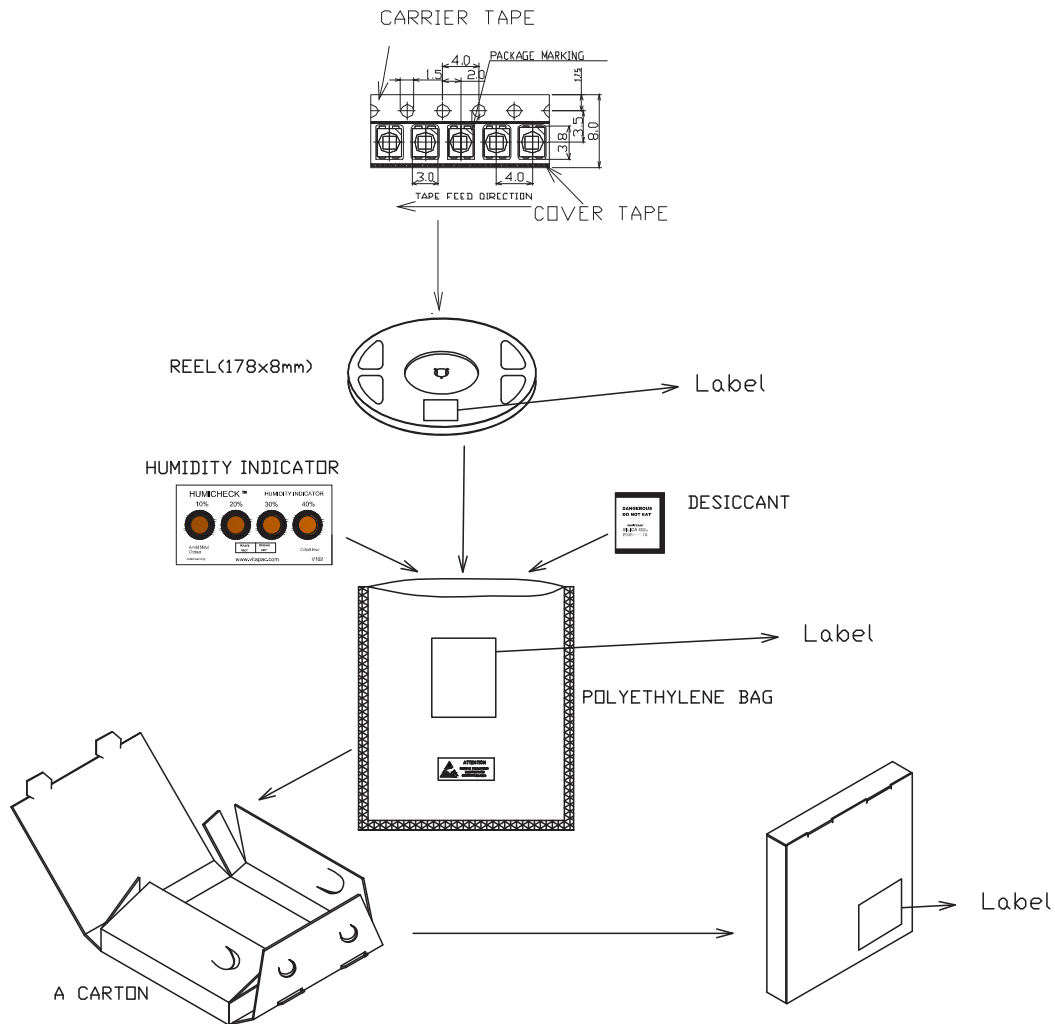

## OUR CERTIFICATE

DiGi provide top-quality products and perfect service for customer worldwide through standardization, technological innovation and continuous improvement. DiGi through third-party certification, we stricly control the quality of products and services. Welcome your RFQ to

Email: [Info@DiGi-Electronics.com](mailto:Info@DiGi-Electronics.com)



Tel: +00 852-30501935

RFQ Email: [Info@DiGi-Electronics.com](mailto:Info@DiGi-Electronics.com)

DiGi is a global authorized distributor of electronic components.