

# CLV1A-FKB-CJ1M1F1BB7D3C3 Datasheet



<https://www.DiGi-Electronics.com>

DiGi Electronics Part Number	CLV1A-FKB-CJ1M1F1BB7D3C3-DG
Manufacturer	<a href="#">CreeLED, Inc.</a>
Manufacturer Product Number	CLV1A-FKB-CJ1M1F1BB7D3C3
Description	LED RGB 4PLCC SMD
Detailed Description	Red, Green, Blue (RGB) 622nm Red, 530nm Green, 468nm Blue LED Indication - Discrete 2V Red, 3.2V Green, 3.2V Blue 4-PLCC

This model CLV1A-FKB-CJ1M1F1BB7D3C3 is available at DiGi Electronics.

DiGi Electronics offers a global database of semiconductor and electronic component datasheets.

We welcome your inquiries regarding pricing, lead time, or other product-related questions.

 [Request a Quote](#)

 [Datasheet Search](#)



Tel: +00 852-30501935

RFQ Email: [Info@DiGi-Electronics.com](mailto:Info@DiGi-Electronics.com)

DiGi is a global authorized distributor of electronic components.

## Purchase and inquiry

Manufacturer Product Number:

CLV1A-FKB-CJ1M1F1BB7D3C3

Series:

CLV1A-FKB

Color:

Red, Green, Blue (RGB)

Lens Color:

-

Millicandela Rating:

675mcd Red, 1055mcd Green, 337mcd Blue

Lens Size:

-

Current - Test:

20mA Red, 20mA Green, 20mA Blue

Mounting Type:

Surface Mount

Wavelength - Peak:

-

Package / Case:

4-PLCC

Size / Dimension:

3.20mm L x 2.80mm W

Base Product Number:

CLV1A

Manufacturer:

CreeLED, Inc.

Product Status:

Discontinued at Digi-Key

Configuration:

Common Anode

Lens Transparency:

-

Lens Style:

Round with Flat Top

Voltage - Forward (Vf) (Typ):

2V Red, 3.2V Green, 3.2V Blue

Viewing Angle:

-

Wavelength - Dominant:

622nm Red, 530nm Green, 468nm Blue

Features:

-

Supplier Device Package:

4-PLCC

Height (Max):

2.10mm

## Environmental & Export classification

RoHS Status:

RoHS Compliant

REACH Status:

REACH Unaffected

HTSUS:

8541.41.0000

Moisture Sensitivity Level (MSL):

5A (24 Hours)

ECCN:

EAR99

## CLV1A-FKB: PLCC4 3 in 1 SMD LED

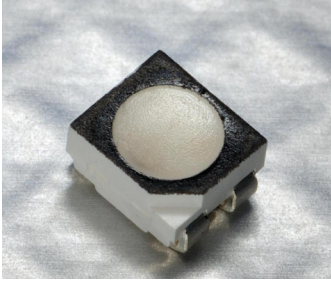

### PRODUCT DESCRIPTION

Cree LED PLCC full-color LEDs offer high-intensity light output and a wide viewing angle in an industry-standard package. Designed to work in a wide array of environmental conditions, Cree LED PLCC full-color LEDs are suited for indoor video screen, decorative lighting and amusement applications.

### FEATURES

- Size (mm): 3.2 x 2.8
- Dominant Wavelength
  - Red (619 - 624nm)
  - Green (520 - 535nm)
  - Blue (460- 475nm)
- Luminous Intensity (mcd)
  - Red (505 - 1010)
  - Green (900 - 2240)
  - Blue (224 - 450)
- Moisture Sensitivity Level: 5a
- Lead-Free
- RoHS Compliant

### APPLICATIONS

- Full-Color Video Screen
- Decorative Lighting
- Amusement

## ABSOLUTE MAXIMUM RATINGS ( $T_A = 25^\circ\text{C}$ )

Items	Symbol	Absolute Maximum Rating			Unit
		R	G	B	
Forward Current <sup>Note 1</sup>	$I_F$	50	25	25	mA
Peak Forward Current <sup>Note 2</sup>	$I_{FP}$	200	100	100	mA
Reverse Voltage	$V_R$	5	5	5	V
Power Dissipation	$P_D$	130	100	100	mW
Operation Temperature	$T_{opr}$	-40 ~ +85			$^\circ\text{C}$
Storage Temperature	$T_{stg}$	-40 ~ +100			$^\circ\text{C}$
Junction Temperature	$T_J$	110	110	110	$^\circ\text{C}$
Junction/ambient 1 chip on	$R_{THJA}$	450	400	450	$^\circ\text{C}/\text{W}$
Junction/ambient 3 chip on	$R_{THJA}$	650	580	680	$^\circ\text{C}/\text{W}$
Junction/solder point 1 chip on	$R_{THJS}$	300	280	300	$^\circ\text{C}/\text{W}$
Junction/solder point 3 chip on	$R_{THJS}$	450	430	480	$^\circ\text{C}/\text{W}$

### Note:

1. Single-color light
2. Pulse width  $\leq 0.1$  msec, duty  $\leq 1/10$ .

## TYPICAL ELECTRICAL & OPTICAL CHARACTERISTICS ( $T_A = 25^\circ\text{C}$ )

Characteristics	Condition	Symbol	Values			Unit
			R	G	B	
Dominant Wavelength	$I_F = 20\text{mA}$	$\lambda_{DOM}$	619~624	520~535	460~475	nm
Spectral bandwidth at 50% $I_{REL}$ max	$I_F = 20\text{mA}$	$\Delta \lambda$	24	38	28	nm
Forward Voltage	$I_F = 20\text{mA}$	$V_{F(avg)}$	2.0	3.2	3.2	V
		$V_{F(max)}$	2.6	4.0	4.0	V
Luminous Intensity	$I_F = 20\text{mA}$	$I_{V(min)}$	505	900	224	mcd
		$I_{V(avg)}$	710	1450	310	mcd
Reverse Current (max)	$V_R = 5\text{V}$	$I_R$	10	10	10	$\mu\text{A}$

\* Continuous reverse voltage can cause LED damage.

## INTENSITY BIN LIMIT

Red (20 mA)			Green (20 mA)			Blue (20 mA)		
Bin Code	Min.(mcd)	Max.(mcd)	Bin Code	Min.(mcd)	Max.(mcd)	Bin Code	Min.(mcd)	Max.(mcd)
km	505	635	N	900	1120	F	224	280
K	560	710	st	1010	1260	de	252	318
np	635	805	P	1120	1400	G	280	355
M	710	900	vw	1260	1600	fg	318	403
qr	805	1010	Q	1400	1800	H	355	450
			xy	1600	2020			
			R	1800	2240			

\* Tolerance of measurement of luminous intensity is  $\pm 10\%$ .

## COLOR BIN LIMIT

Red (20 mA)			Green (20 mA)			Blue (20 mA)		
Bin Code	Min.(nm)	Max.(nm)	Bin Code	Min.(nm)	Max.(nm)	Bin Code	Min.(nm)	Max.(nm)
RB	619	624	G7	520	525	B3	460	465
			G23	522.5	527.5	B23	462.5	467.5
			G8	525	530	B4	465	470
			G45	527.5	532.5	B45	467.5	472.5
			G9	530	535	B5	470	475

\* Tolerance of measurement of dominant wavelength is  $\pm 1$  nm.

## ORDER CODE TABLE

Kit Number	Color	Luminous Intensity (mcd)		Dominant Wavelength (nm)				Package
		Min.	Max.	Color Bin	Min.(nm)	Color Bin	Max. (nm)	
CLV1A-FKB-CkmqrNRFHBB79353	Red	505	1010	RB	619	RB	624	Reel
	Green	900	2240	G7	520	G9	535	Reel
	Blue	224	450	B3	460	B5	475	Reel
CLV1A-FKB-Ckm1P1F1BB7C3C3	Red	Any 1 Intensity bin from km(505) - qr(1010)		RB	619	RB	624	Reel
	Green	Any 1 Intensity bin from P(1120) - R(2240)		Any 1 hue bin from G7(520)-G9(535)				Reel
	Blue	Any 1 Intensity bin from F(224) - H(450)		Any 1 hue bin from B3(460)-B5(475)				Reel
CLV1A-FKB-CK1vw1de1BB7C3C3	Red	Any 1 Intensity bin from K(560) - qr(1010)		RB	619	RB	624	Reel
	Green	Any 1 Intensity bin from vw(1260) - R(2240)		Any 1 hue bin from G7(520)-G9(535)				Reel
	Blue	Any 1 Intensity bin from de(252) - H(450)		Any 1 hue bin from B3(460)-B5(475)				Reel

## Notes:

- The above kit numbers represent order codes that include multiple intensity-bin and color-bin codes. Only one intensity-bin code and one color-bin code will be shipped on each bulk. Single intensity-bin code and single color-bin codes will not be orderable.
- Please refer to the [HB LED Lamp Reliability Test Standards](#) document for reliability test conditions.
- Please refer to the [HB LED Lamp Soldering & Handling](#) document for information about how to use this LED product safely.

**GRAPHS**

The data below are collected from statistical figures that do not necessarily correspond to the actual parameters of each single LED. Hence, these data will be changed without further notice.

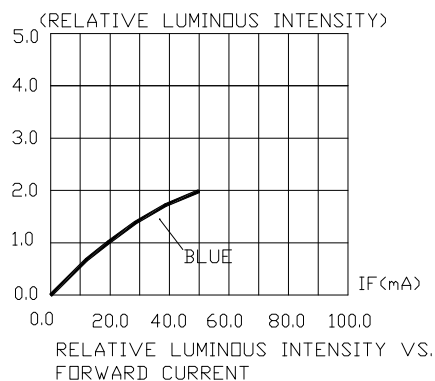
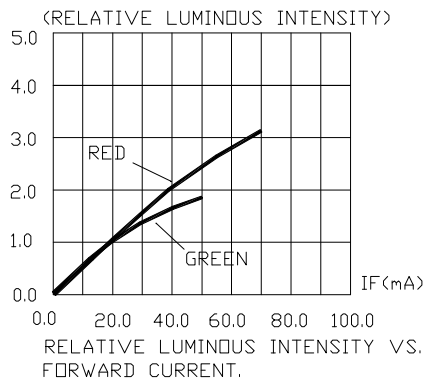
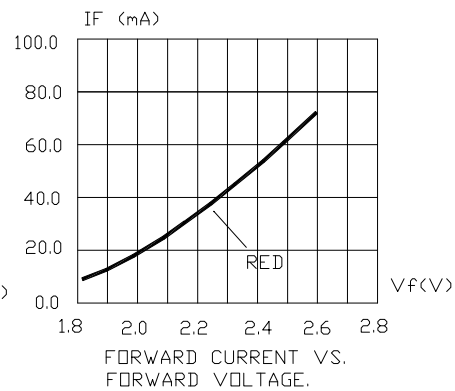
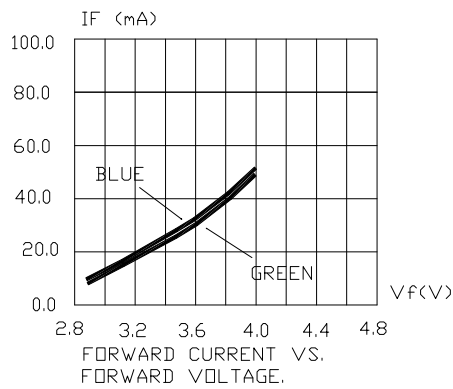
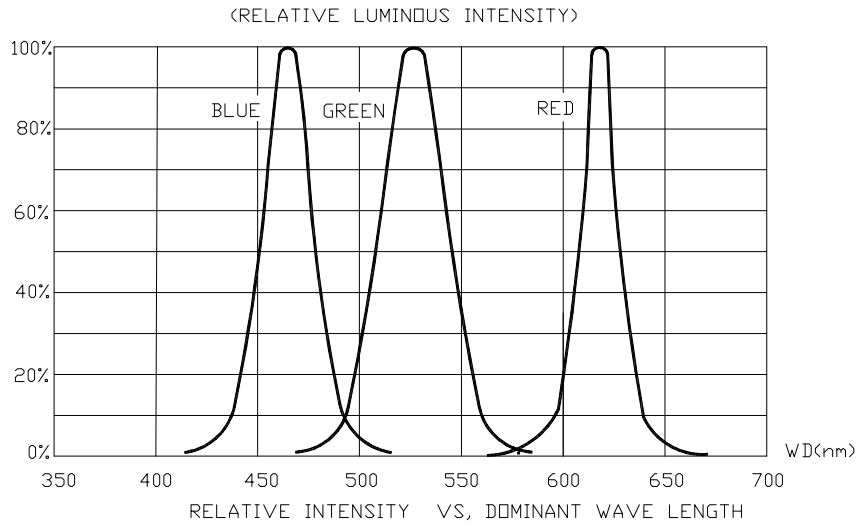

**GRAPHS**

The data below are collected from statistical figures that do not necessarily correspond to the actual parameters of each single LED. Hence, these data will be changed without further notice.

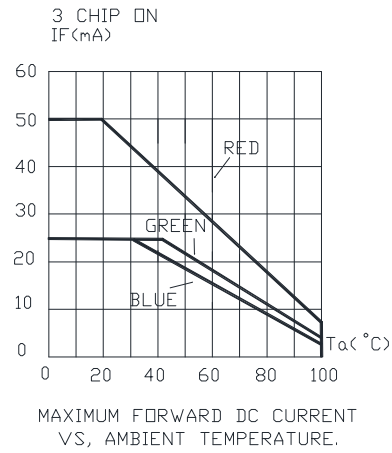
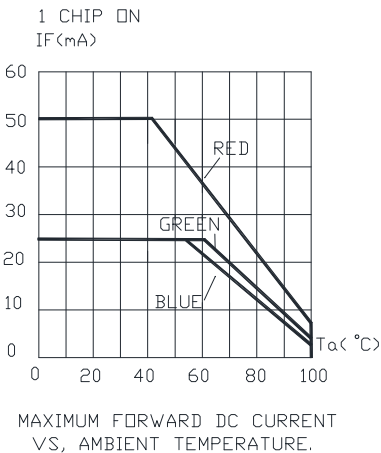
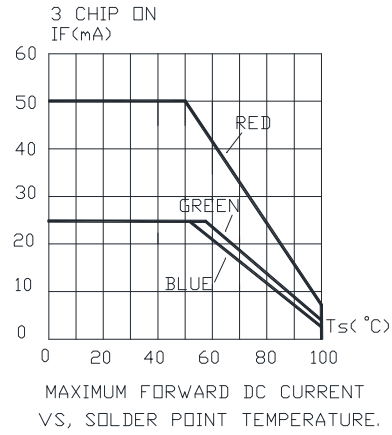
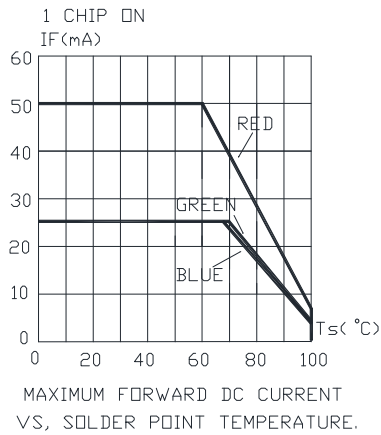
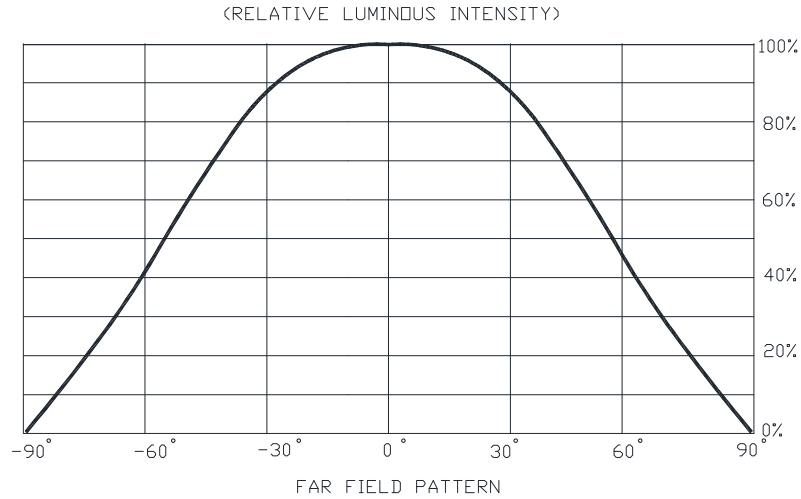

## MECHANICAL DIMENSIONS

All dimensions are in mm.

Tolerance of measurement of the dimension is  $\pm 0.1$ .

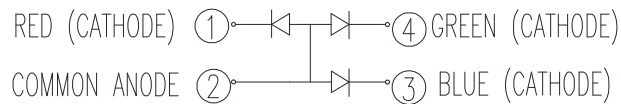
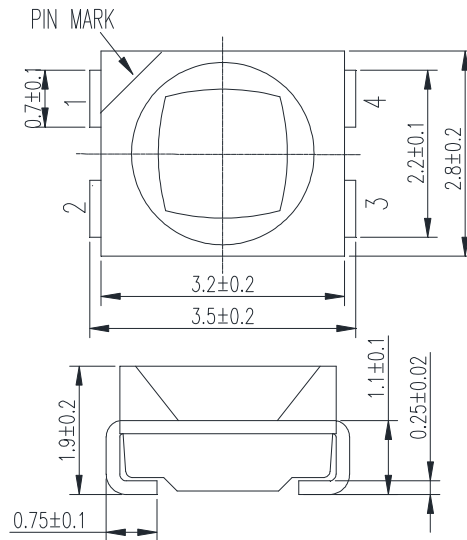

## NOTES

### RoHS Compliance

The levels of RoHS restricted materials in this product are below the maximum concentration values (also referred to as the threshold limits) permitted for such substances, or are used in an exempted application, in accordance with EU Directive 2011/65/EC (RoHS2), as implemented January 2, 2013. RoHS Declarations for this product can be obtained from your Cree LED representative or from the [Product Ecology](#) section of the Cree LED website.

### Vision Advisory

**WARNING:** Do not look at an exposed lamp in operation. Eye injury can result.

**KIT NUMBER SYSTEM**

Cree LED lamps are tested and sorted into performance bins. A bin is specified by ranges of color, forward voltage, and brightness.

Cree LEDs are sold by order codes in combinations of bins called kits. Order codes are configured in the following manner:

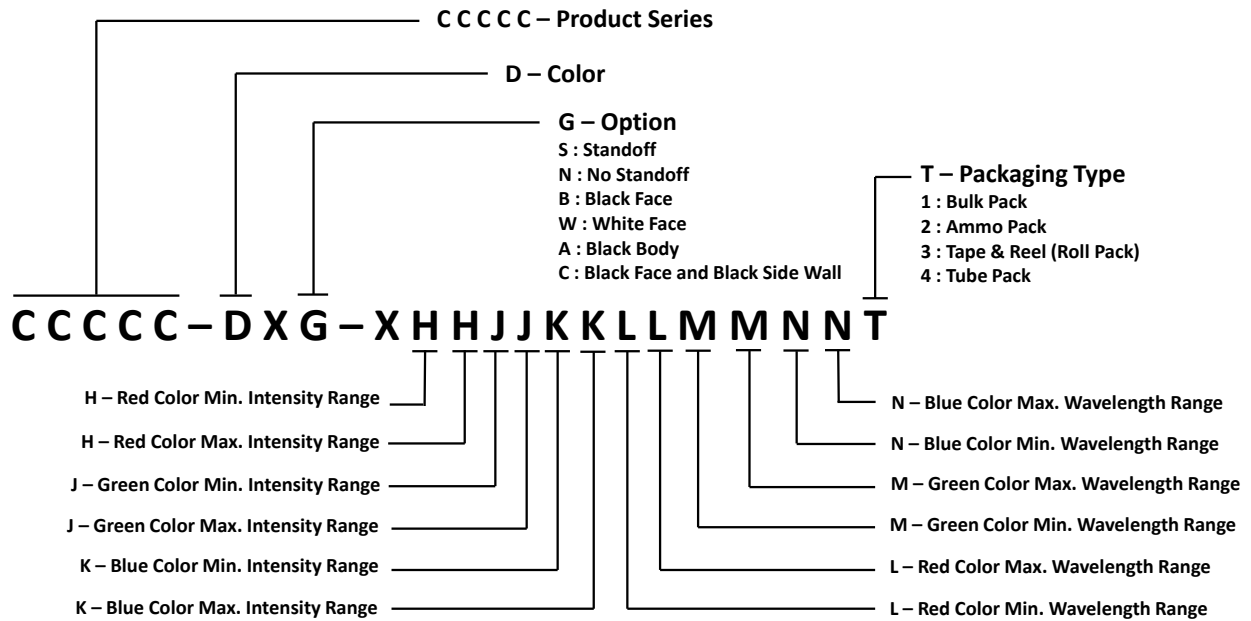

## REFLOW SOLDERING

- The CLV1A-FKB is rated as a MSL 5a product.
- The recommended floor life out of bag is 24hrs.
- The temperature profile is as below.

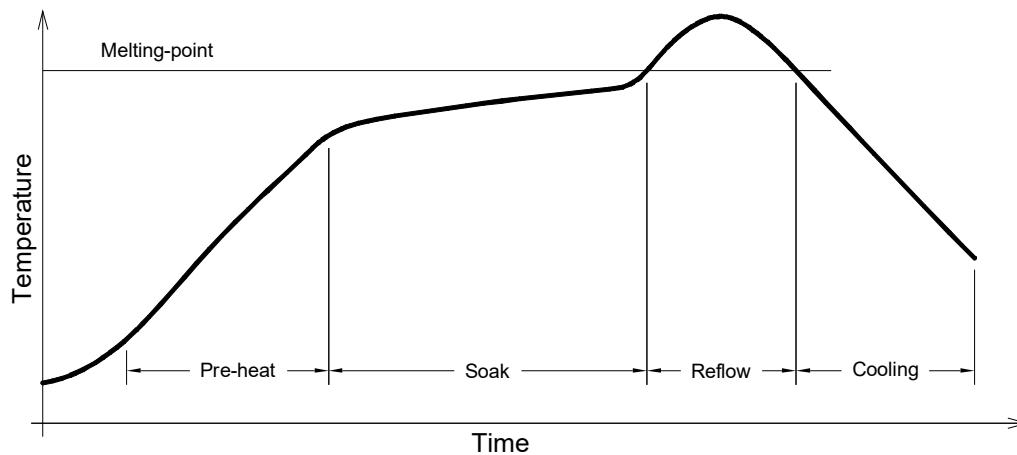

### Use only with CLV1A-FKB

Solder
Average ramp-up rate = 4°C/s max
Preheat temperature = 150°C ~200°C
Preheat time = 120s max
Ramp-down rate = 6°C/s max
Peak temperature = 250°C max
Time within 5°C of actual Peak Temperature = 10s max
Duration above 217°C is 60s max

## NOTES

- The packaging sizes of these SMD products are very small and the resin is still soft after solidification. Users are required to handle with care. Never touch the resin surface of SMD products.
- To avoid damaging the product's surface and interior device, it is recommended to choose a special nozzle to pick up the SMD products during the process of SMT production. If handling is necessary, take special care when picking up these products. The following method is necessary:

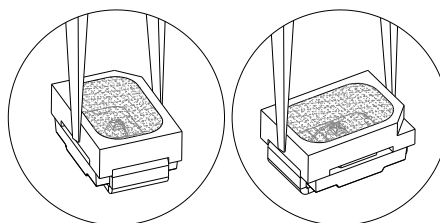

## PACKAGING

- The CLV1A-FKB is rated as a MSL 5a product.
- The boxes are not water resistant and they must be kept away from water and moisture.
- The LEDs are packed in cardboard boxes after packaging in normal or anti-electrostatic bags.
- Cardboard boxes will be used to protect the LEDs from mechanical shocks during transportation.
- The reel pack is applied in SMD LED.
- Max 2000 pcs per reel.

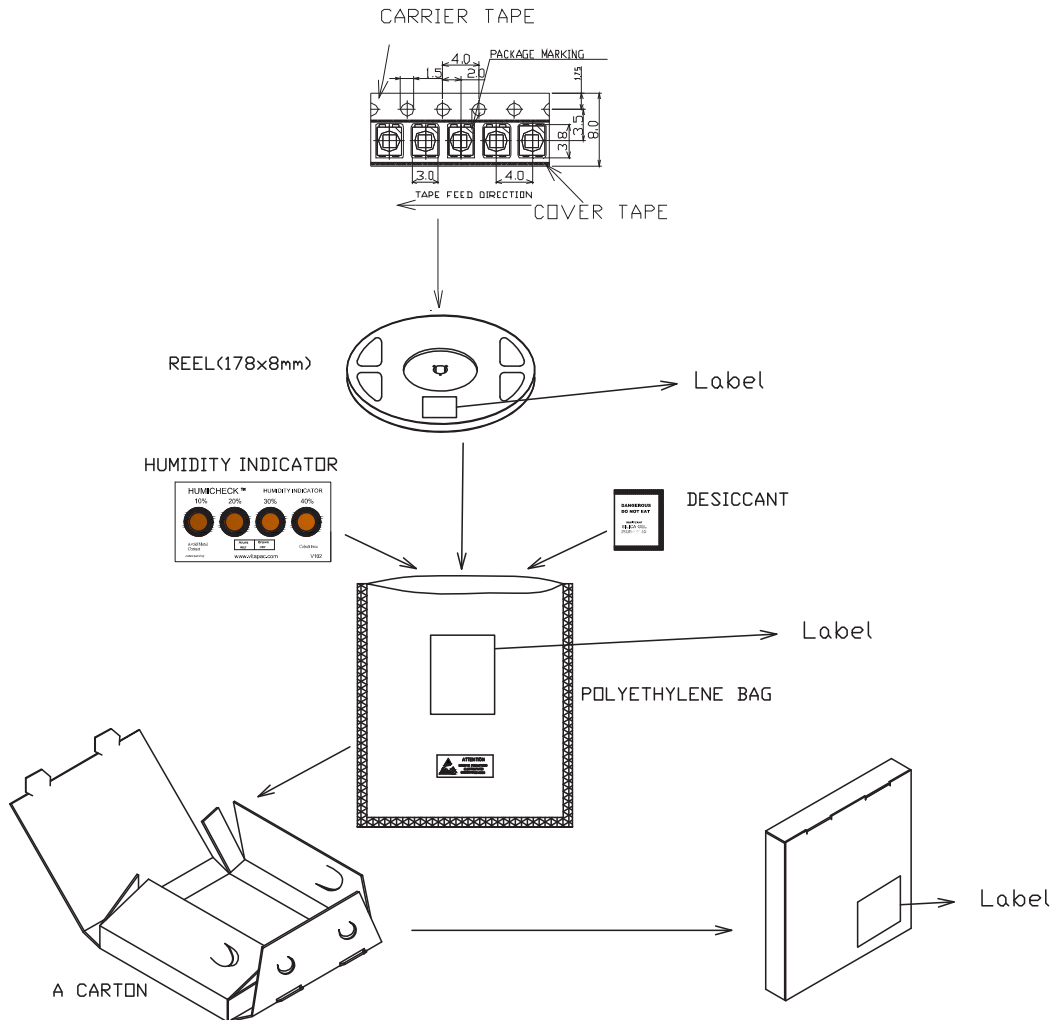

## OUR CERTIFICATE

DiGi provide top-quality products and perfect service for customer worldwide through standardization, technological innovation and continuous improvement. DiGi through third-party certification, we stricly control the quality of products and services. Welcome your RFQ to

Email: [Info@DiGi-Electronics.com](mailto:Info@DiGi-Electronics.com)



Tel: +00 852-30501935

RFQ Email: [Info@DiGi-Electronics.com](mailto:Info@DiGi-Electronics.com)

DiGi is a global authorized distributor of electronic components.