

A123S1CWCG Datasheet



DiGi Electronics Part Number	A123S1CWCG-DG
Manufacturer	Electroswitch
Manufacturer Product Number	A123S1CWCG
Description	SWITCH TOGGLE SPDT 6A 125V
Detailed Description	Toggle Switch SPDT Panel Mount

<https://www.DiGi-Electronics.com>

This model A123S1CWCG is available at DiGi Electronics.

DiGi Electronics offers a global database of semiconductor and electronic component datasheets.

We welcome your inquiries regarding pricing, lead time, or other product-related questions.

 [Request a Quote](#)

 [Datasheet Search](#)



Tel: +00 852-30501935

RFQ Email: Info@DiGi-Electronics.com

DiGi is a global authorized distributor of electronic components.

Purchase and inquiry

Manufacturer Product Number:

A123S1CWCG

Series:

A

Mounting Type:

Panel Mount

Switch Function:

On-On

Voltage Rating - AC:

125 V

Actuator Type:

Standard Round

Illumination:

Non-Illuminated

Illumination Voltage (Nominal):

-

Panel Cutout Dimensions:

-

Ingress Protection:

Splash Proof

Operating Temperature:

-30°C ~ 90°C

Electrical Life:

60,000 Cycles

Manufacturer:

Electroswitch

Product Status:

Active

Circuit:

SPDT

Current Rating (Amps):

6A (AC/DC)

Voltage Rating - DC:

28 V

Actuator Length:

10.41mm

Illumination Type, Color:

-

Termination Style:

PC Pin

Bushing Thread:

1/4-40

Features:

Epoxy Sealed Terminals

Actuator Material:

Brass, Chrome Plated

Base Product Number:

A123S1

Environmental & Export classification

RoHS Status:

RoHS Compliant

REACH Status:

Vendor Undefined

HTSUS:

8536.50.9065

Moisture Sensitivity Level (MSL):

Not Applicable

ECCN:

EAR99

Ordering Table — Standard Toggle Switches

HOW TO ORDER YOUR DESIGN (Bold Face Type indicates items normally in Distributor Stock)

Following the table from left to right, the designer is able to specify the options wanted. The options are described and illustrated on pages 24-31. Refer to page 57 for mounting hardware.

To determine a part number select the options desired and fill in the boxes in the selection guides illustrated below.

Toggle Switch Selection Guide

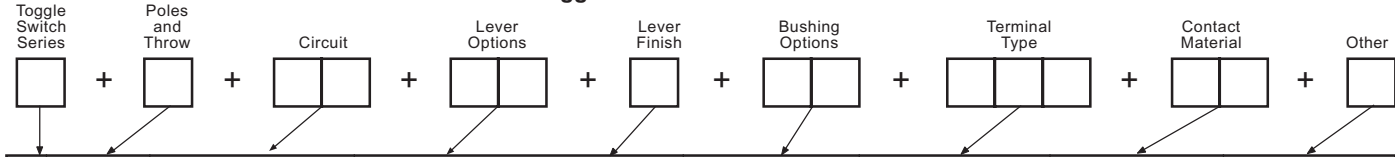

Series	Poles and Throw		Circuits ¹⁰				Lever Options and Finishes				Bushing Options		Terminal Options ⁷		Contact Material		Other Option																																					
	No.	Code	Keyway		Code	Type	Code	Finish	Code	Type	Code	Type	Code	Type	Code	Type	Code																																					
A	SPDT	1			POS. "C"	Lever Lock K Bushing Only	K1	Bright Chrome ¹⁴	1	Splashproof Lever ⁹ & Bushing Seal	CW	Right Angle PC ¹¹	A	Gold/Nickel/Brass	B	Epoxy Sealed ⁷																																						
	DPDT	2	ON	OFF	ON	.840 Bat	L0	Stain Chrome	2	Splashproof ⁹	CX	Vertical PC .100 Spacing	AV	Gold/Nickel/Silver	G	Anti-Rotation	P																																					
	3PDT	3	ON	NONE	ON	.640 Bat	L1	Black ¹	3	Lever Seal Only	D	Vertical PC .150 Spacing	AV2	Coin Silver	Q	Anti-Jam																																						
	4PDT	4	ON	NONE	ON*	Long Mod Cap Short Mod Cap	L2	Black Nylon ⁸	4	.280 Threaded ²	D9	Printed Circuit Terminals	C	15	L	M																																						
							L3		5										.350 Flatted With Shoulder	H3	Right Angle ⁹ Same Throw	R																																
							L4		6																.350 Keyway With Shoulder	K	Right Angle ⁹ Opposite Throw	R2																										
							M																								Locking K1 Lever Only	K	PC & Support ⁶	V30																				
							P1																														15/32 Dia. ¹²	T	PC & Support ⁶	V40														
							P3																																				Splashproof Lever ¹² 15/32 & Panel Seal	TW	PC & Support ⁶	V60								
							P4																																										15/32 Splashproof ¹² Lever Seal Only	TX	PC & Support ⁶	V70		
							S																																															
	T		.437 Threaded (With P3 Only)	Y5	.964 Wire Wrap	W1																																																
									.350 Smooth	Y9	1.062 Wire Wrap	W3																																										
																	Solder Lugs	Z																																				
																	Quick Connect	Z3																																				

*Momentary Contact

- ¹ Available on S, M and P3 only.
- ² Add .070 to lever length when using these bushings.
- ³ Available with S, M, L0, L1, L2, L3, L4 lever options. Consult factory for availability.
- ⁴ Standard on P1, P3, P4 and K1 lever options. Available on all other levers except T & T1.
- ⁵ These circuits are **NOT** available with the following 3 and 4 pole options: A, AV, AV2, V30, V40, V60 and V70.
- ⁶ 1 and 2 pole only.
- ⁷ Epoxy seal standard on all terminal options.

- ⁸ Available only with L3 and L4 levers.
- ⁹ Available in 1 pole only.
- ¹⁰ See page 58 for construction detail, wiring and electrical diagrams.
- ¹¹ 1, 2 and 3 pole only.
- ¹² Available on T or T1 lever options only.
- ¹³ Available on T, TW, and TX bushing options. (Bright chrome only.)
- ¹⁴ Not available on K1 lever.
- ¹⁵ Same as B, G and Q respectively except terminals brass with tin nickel alloy over nickel plate. Consult plant for availability.

EXAMPLES:

A232L01YW1B = DPDT toggle switch with an ON-ON-ON circuit, .840" long lever in a bright chrome finish, .350 threaded bushing, .964" long wire wrap terminals, gold/brass contacts and epoxy sealed terminals.

SPECIFICATIONS:

Contact Ratings —

Letter codes G and Q — 6 amp at 125 VAC, 3 amp @ 250 VAC (U.L. recognized, CSA certified) or 6 amp at 28 VDC resistive.
Letter codes B and G — 0.5. volt-amp (VA) maximum @ 28 V maximum (AC or DC).

Life Under Load — 60,000 make-and-break cycles — resistive load only.

Initial Contact Resistance — 10 milliohms maximum 3 VDC, 100 ma for both silver and gold plated contacts.

Insulation Resistance — 1 & 2 pole —1,000 megohms, min.
3 & 4 pole —1,000 megohms, min.

Dielectric Strength — 1,000 volts rms at sea level.

Bushing Strength — 12 pound-inches without physical damage to switch.

Weight (including hardware) — SP 0.19 oz.; DP 0.23 oz.; 3-pole 0.28 oz.; 4-pole 0.32 oz.

MATERIALS:

Base (body) — 1- and 2-pole —Diallyl Phthalate (DAP).
3- and 4-pole — high strength phenolic.

Lever (toggle) — Brass, chrome plated.

Flat Lever — Brass, satin chrome finish.

Locking lever cap — Anodized aluminum.

Bushing — Brass, nickel plated.

Clamp (frame) — Stainless steel.

Support brackets — Steel, tin plated.

Switching Contacts and Rockers —

- Letter Code B — gold/nickel/brass
- Letter Code G — gold/nickel/silver
- Letter Code Q — Coin silver

Center Terminal

- Letter Codes B, G — Gold flash/nickel/brass
- Letter Code Q — Silver plated brass.

Hardware — See page 55-57.

Toggle Switches — Base Dimensions and Lever Options

APPROXIMATE BASE DIMENSIONS

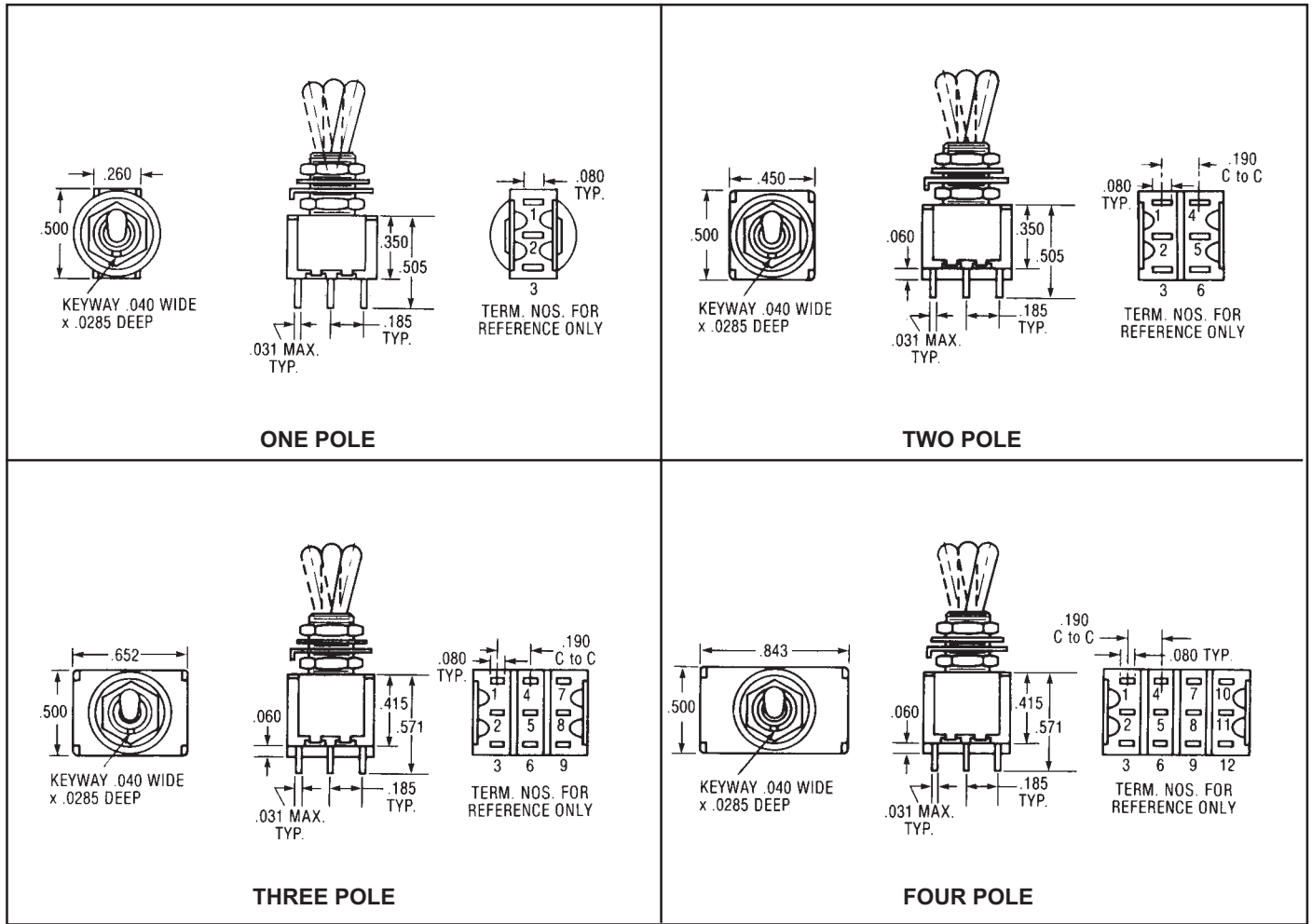

TOGGLE LEVER OPTIONS

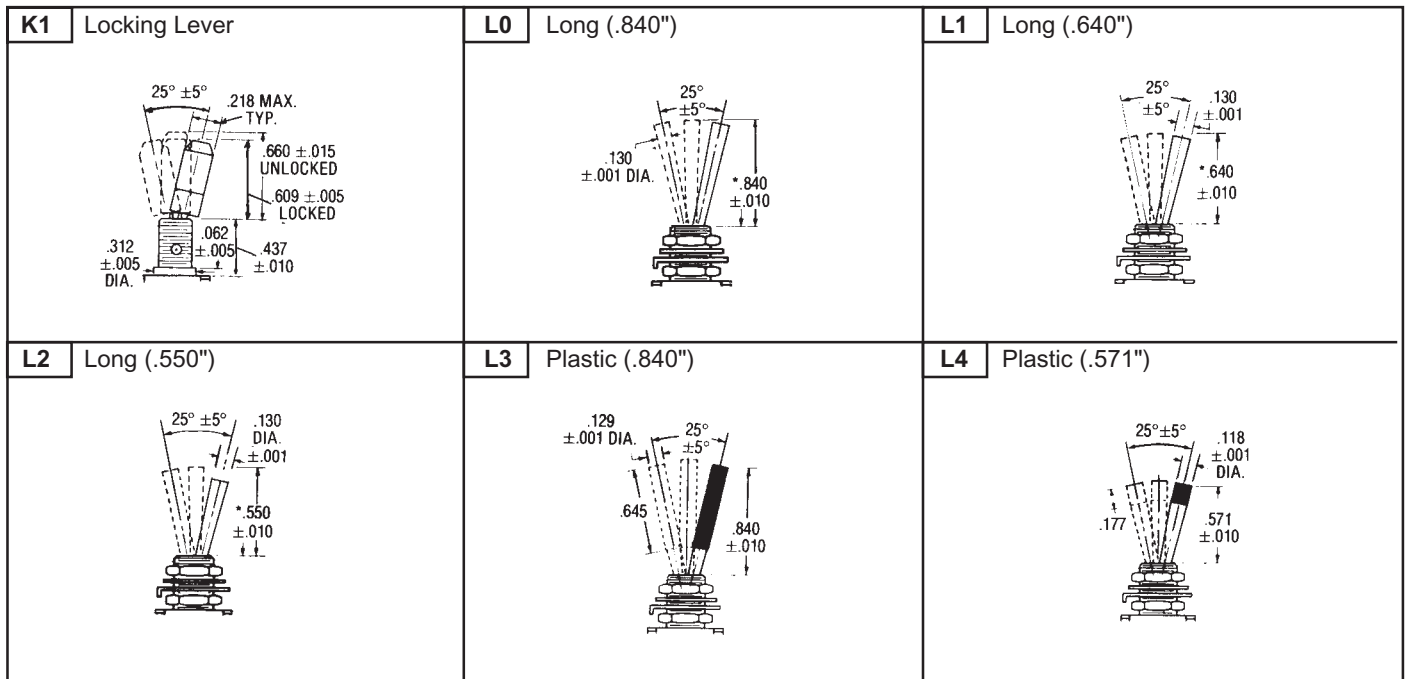

Toggle Lever Options — Contd.

<p>M Short (.200")</p>	<p>P1 Flatted (.840")</p>	<p>P3 Flatted (.448")</p>	<p>P4 Flatted (.250")</p>
<p>S Std. Bat (.410")</p>	<p>T Large Toggle</p>	<p>T1 Large Toggle</p>	

BUSHING OPTIONS

<p>CW Splashproof Sealed Lever and Panel Seal</p> <p>CW = Flatted bushing</p>	<p>D D9 Threaded Smooth (No Keyway)</p>	
<p>H High Torque Flatted with Shoulder</p>	<p>H3 High Torque</p> <p>.228 OVER FLAT</p>	<p>P Anti-Rotation</p>
<p>TW Splashproof Sealed Lever and Panel Seal</p>	<p>OX Y Y9 Threaded with Lever Seal Threaded Smooth (No Keyway)</p>	<p>Y5 Long Bushing (.437")</p>

K Refer to K1 lever drawing for dimensions.

T&TX Refer to T or T1 lever drawing for dimensions.

Note: For hardware refer to pages 55-57.

MINIATURE SWITCHES

Termination Options

<p>C Printed CIRCUIT</p>	<p>W Wire-Wrap</p>	<p>W1 Wire-Wrap</p>	<p>W3 Wire-Wrap</p>	<p>W4 Wire-Wrap</p>	<p>Z STANDARD</p>	<p>Z3 Quick CONNECT</p> <p>Mating Receptacle from AMP SPECIAL IND., P.O. Box 984, Paoli, Pa. 19301 Amp P/N single piece 61454 series, strip from 60900</p>
---------------------------------	---------------------------	----------------------------	----------------------------	----------------------------	--------------------------	---

NOTE: Wire-Wrap is a registered trademark of the Gardner-Denver Company.

TERMINATION/MOUNTING OPTIONS

A

One Pole

A

Two Pole

Right Angle P.C. Terminal

EPOXY SEAL STD. FOR THIS OPTION

A

Three Pole

R

One Pole

Contacts Make on Opposite Side Toggle Thrown

R2

One Pole

Contacts Make on Opposite Side Toggle Thrown

Termination/Mounting Options

AV1	w/.100" terminal spacing
AV2	w/.150" terminal spacing (pictured below)

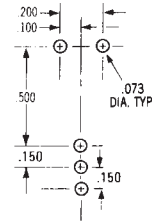
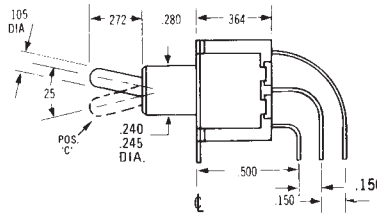
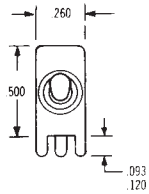

ONE POLE Epoxy sealed P.C. terminals are supplied as standard for these options.

AV1	w/.100" terminal spacing
AV2	w/.150" terminal spacing (pictured below)

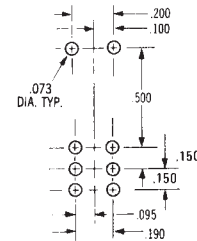
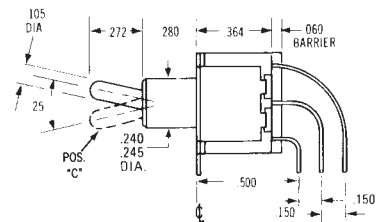
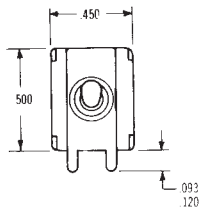

TWO POLE Epoxy sealed P.C. terminals are supplied as standard for these options.

AV	w/.100" terminal spacing
AV2	w/.150" terminal spacing (pictured below)

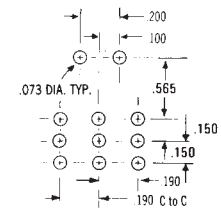
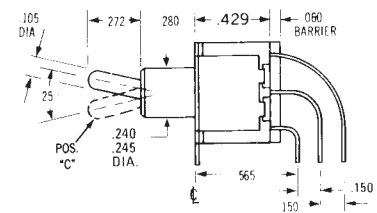
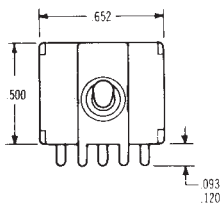

THREE POLE Epoxy sealed P.C. terminals are supplied as standard for these options.

AV	w/.100" terminal spacing
AV2	w/.150" terminal spacing (pictured below)

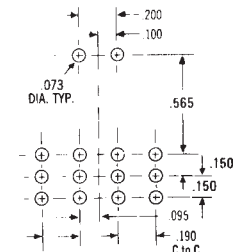
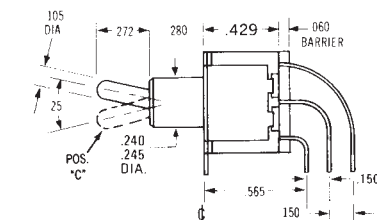
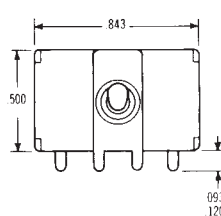

FOUR POLE Epoxy sealed P.C. terminals are supplied as standard for these options.

MINIATURE SWITCHES

Termination/Mounting Options

V30

ONE POLE

TWO POLE

BRACKET WIDTH

.312 (7.9)

620 (15.7)

25°

.105 (2.6) DIA.

.270 (6.8)

240 (6.1) DIA.

245 (6.2) DIA.

.280 (7.1)

620 (15.7)

.270 (6.8)

.280 (7.1)

.460 (11.7)

.184 (4.6)

.125 (3.1)

.046 (1.2)

1 Pole P.C. Mounting

.073 (1.8) DIA. TYP.

.185 (4.7) TYP.

.125 (3.1)

.620 (15.7)

2 Pole P.C. Mounting

.073 (1.8) DIA. TYP.

.125 (3.1)

.190 (4.8)

.185 (4.7) TYP.

.620 (15.7)

EPOXY SEALED P.C. TERMINALS ARE SUPPLIED AS STANDARD FOR THESE OPTIONS

V40

ONE POLE

TWO POLE

BRACKET WIDTH

.312 (7.9)

620 (15.7)

25°

.270 (6.8)

.280 (7.1)

240 (6.1) DIA.

245 (6.2) DIA.

.030 (7.6) TYP.

.020 (5) ±.002

620 (15.7) ϕ TO ϕ

.105 (2.6) DIA.

+.003

.630 (16)

.312 (8)

.184 (4.6)

.125 (3.1)

.046 (1.2) TYP.

1 Pole P.C. Mounting

.073 (1.8) DIA. TYP.

.185 (4.7) TYP.

.125 (3.1)

.620 (15.7)

2 Pole P.C. Mounting

.073 (1.8) DIA. TYP.

.125 (3.1)

.190 (4.8)

.185 (4.7) TYP.

.620 (15.7)

EPOXY SEALED P.C. TERMINALS ARE SUPPLIED AS STANDARD FOR THESE OPTIONS

V60

ONE POLE

TWO POLE

BRACKET WIDTH

.360 (9.1)

750 (19)

25°

.105 (2.6) DIA.

.270 (6.8)

240 (6.1) DIA.

245 (6.2) DIA.

.280 (7.1)

750 (19)

.270 (6.8)

.280 (7.1)

.460 (11.7)

.187 (4.7)

.250 (6.3)

.050 (1.3)

1 Pole P.C. Mounting

.073 (1.8) DIA. TYP.

.185 (4.7) TYP.

.250 (6.3)

.750 (19)

2 Pole P.C. Mounting

.073 (1.8) DIA. TYP.

.190 (4.8)

.185 (4.7) TYP.

.750 (19)

EPOXY SEALED P.C. TERMINALS ARE SUPPLIED AS STANDARD FOR THESE OPTIONS

V70

ONE POLE

TWO POLE

BRACKET WIDTH

.360 (9.1)

750 (19)

25°

.270 (6.8)

.280 (7.1)

240 (6.1) DIA.

245 (6.2) DIA.

.030 (7.6) TYP.

.020 (5) ±.002

750 (19) ϕ TO ϕ

.105 (2.6) DIA.

+.003

.630 (16)

.360 (9.1)

.187 (4.7)

.250 (6.3)

.050 (1.3) TYP.

1 Pole P.C. Mounting

.073 (1.8) DIA. TYP.

.185 (4.7) TYP.

.250 (6.3)

.750 (19)

2 Pole P.C. Mounting

.073 (1.8) DIA. TYP.

.190 (4.8)

.185 (4.7) TYP.

.750 (19)

EPOXY SEALED P.C. TERMINALS ARE SUPPLIED AS STANDARD FOR THESE OPTIONS

OUR CERTIFICATE

DiGi provide top-quality products and perfect service for customer worldwide through standardization, technological innovation and continuous improvement. DiGi through third-party certification, we stricly control the quality of products and services. Welcome your RFQ to

Email: Info@DiGi-Electronics.com



Tel: +00 852-30501935

RFQ Email: Info@DiGi-Electronics.com

DiGi is a global authorized distributor of electronic components.