

# PKB4910API Datasheet



<https://www.DiGi-Electronics.com>

DiGi Electronics Part Number	PKB4910API-DG
Manufacturer	<a href="#">Flex Power Modules</a>
Manufacturer Product Number	PKB4910API
Description	DC DC CONVERTER 3.3V 99W
Detailed Description	Isolated Module DC DC Converter 1 Output 3.3V 30A 36V - 72V Input

This model PKB4910API is available at DiGi Electronics.

DiGi Electronics offers a global database of semiconductor and electronic component datasheets.

We welcome your inquiries regarding pricing, lead time, or other product-related questions.

 [Request a Quote](#)

 [Datasheet Search](#)



Tel: +00 852-30501935

RFQ Email: [Info@DiGi-Electronics.com](mailto:Info@DiGi-Electronics.com)

DiGi is a global authorized distributor of electronic components.

## Purchase and inquiry

Manufacturer Product Number:

PKB4910API

Series:

PKB4000A (125W)

Type:

Isolated Module

Voltage - Input (Min):

36V

Voltage - Output 1:

3.3V

Voltage - Output 3:

-

Current - Output (Max):

30A

Voltage - Isolation:

2.25 kV

Features:

Adjustable Output, Remote On/Off, Remote Sense

Efficiency:

92.7%

Package / Case:

Eighth Brick

Supplier Device Package:

Eighth Brick

Approval Agency:

CB, CSA, IEC, TUV, UL

Base Product Number:

PKB491

Manufacturer:

Flex Power Modules

Product Status:

Last Time Buy

Number of Outputs:

1

Voltage - Input (Max):

72V

Voltage - Output 2:

-

Voltage - Output 4:

-

Power (Watts):

99 W

Applications:

ITE (Commercial)

Operating Temperature:

-40°C ~ 125°C (With Derating)

Mounting Type:

Through Hole

Size / Dimension:

2.30" L x 0.89" W x 0.33" H (58.4mm x 22.7mm x 8.5mm)

Control Features:

Enable, Active Low

Standard Number:

62368-1

## Environmental & Export classification

RoHS Status:

ROHS3 Compliant

REACH Status:

REACH Unaffected

HTSUS:

8504.40.9580

Moisture Sensitivity Level (MSL):

Not Applicable

ECCN:

EAR99



Technical Specification

**D?6 ( \$\$\$5 series Direct Converters**  
 Input 36-72 V, Output up to 30 A / 125 W

EN/LZT 146 420 R4A October 2017

© Flex

**Key Features**

- Industry standard low profile Eighth-brick  
 58.4 x 22.7 x 8.50 mm (2.30 x 0.894 x 0.339 in)
- High efficiency, typ. 93.3% at 5.0 Vout half load
- 2250 Vdc input to output isolation
- Meets isolation requirements equivalent to basic insulation according to IEC/EN/UL 60950
- More than 1.6 million hours MTBF

**General Characteristics**

- Output over voltage protection
- Input under voltage shutdown
- Over temperature protection
- Monotonic startup
- Output short-circuit protection
- Remote sense
- Remote control
- Output voltage adjust function
- Highly automated manufacturing ensures quality
- ISO 9001/14001 certified supplier



**Safety Approvals**



**Design for Environment**



Meets requirements in high-temperature lead-free soldering processes.

**Contents**

Ordering Information	.....	2
General Information	.....	2
Safety Specification	.....	3
Absolute Maximum Ratings	.....	4
Electrical Specification		
3.3V, 30 A / 99 W	PKB 4910A .....	5
5.0V, 25 A / 125 W	PKB 4111A .....	9
EMC Specification	.....	13
Operating Information	.....	14
Thermal Consideration	.....	15
Connections	.....	16
Mechanical Information	.....	17
Soldering Information	.....	19
Delivery Information	.....	20
Product Qualification Specification	.....	21



**D?6 ( \$\$\$\$ series Direct Converters**  
Input 36-72 V, Output up to 30 A / 125 W

EN/LZT 146 420 R4A October 2017

© Flex

### Ordering Information

Product program	Output
PKB 4910A	3.3 V, 30 A / 99 W
PKB 4111A	5.0 V, 25 A / 125 W

### Product number and Packaging

PKB 4XXXXA n <sub>1</sub> n <sub>2</sub> n <sub>3</sub>			
Options	n <sub>1</sub>	n <sub>2</sub>	n <sub>3</sub>
Mounting	o		
Remote Control logic		o	
Lead length			o

Options	Description
n <sub>1</sub>	PI Through hole * SI Surface mount
n <sub>2</sub>	Negative * P Positive
n <sub>3</sub>	5.30 mm * LA 3.69 mm LB 4.57 mm

Example a through-hole mounted, negative logic, short pin product would be PKB 4910A PILA.

\* Standard variant (i.e. no option selected).

### General Information

#### Reliability

The Mean Time Between Failure (MTBF) is calculated at full output power and an operating ambient temperature (T<sub>A</sub>) of +40°C, which is a typical condition in Information and Communication Technology (ICT) equipment. Different methods could be used to calculate the predicted MTBF and failure rate which may give different results. Flex currently uses Telcordia SR332.

Predicted MTBF for the series is:

- 1.6 million hours according to Telcordia SR332, issue 1, Black box technique.

Telcordia SR332 is a commonly used standard method intended for reliability calculations in ICT equipment. The parts count procedure used in this method was originally modelled on the methods from MIL-HDBK-217F, Reliability Predictions of Electronic Equipment. It assumes that no reliability data is available on the actual units and devices for which the predictions are to be made, i.e. all predictions are based on generic reliability parameters.

#### Compatibility with RoHS requirements

The products are compatible with the relevant clauses and requirements of the RoHS directive 2002/95/EC and have a maximum concentration value of 0.1% by weight in homogeneous materials for lead, mercury, hexavalent chromium, PBB and PBDE and of 0.01% by weight in

homogeneous materials for cadmium.

Exemptions in the RoHS directive utilized in Flex products include:

- Lead in high melting temperature type solder (used to solder the die in semiconductor packages)
- Lead in glass of electronics components and in electronic ceramic parts (e.g. fill material in chip resistors)
- Lead as an alloying element in copper alloy containing up to 4% lead by weight (used in connection pins made of Brass)

### Quality Statement

The products are designed and manufactured in an industrial environment where quality systems and methods like ISO 9000, 6σ (sigma), and SPC are intensively in use to boost the continuous improvements strategy. Infant mortality or early failures in the products are screened out and they are subjected to an ATE-based final test. Conservative design rules, design reviews and product qualifications, plus the high competence of an engaged work force, contribute to the high quality of our products.

### Warranty

Warranty period and conditions are defined in Flex General Terms and Conditions of Sale.

### Limitation of Liability

Flex does not make any other warranties, expressed or implied including any warranty of merchantability or fitness for a particular purpose (including, but not limited to, use in life support applications, where malfunctions of product can cause injury to a person's health or life).

### © Flex 2017

The information and specifications in this technical specification is believed to be correct at the time of publication. However, no liability is accepted for inaccuracies, printing errors or for any consequences thereof. Flex reserves the right to change the contents of this technical specification at any time without prior notice.



**D?6 ( \$\$\$\$ series Direct Converters**  
Input 36-72 V, Output up to 30 A / 125 W

EN/LZT 146 420 R4A October 2017

© Flex

## Safety Specification

### General information

Flex DC/DC converters and DC/DC regulators are designed in accordance with safety standards IEC/EN/UL60950, *Safety of Information Technology Equipment*.

IEC/EN/UL60950 contains requirements to prevent injury or damage due to the following hazards:

- Electrical shock
- Energy hazards
- Fire
- Mechanical and heat hazards
- Radiation hazards
- Chemical hazards

On-board DC-DC converters and DC/DC regulators are defined as component power supplies. As components they cannot fully comply with the provisions of any Safety requirements without "Conditions of Acceptability". Clearance between conductors and between conductive parts of the component power supply and conductors on the board in the final product must meet the applicable Safety requirements. Certain conditions of acceptability apply for component power supplies with limited stand-off (see Mechanical Information for further information). It is the responsibility of the installer to ensure that the final product housing these components complies with the requirements of all applicable Safety standards and Directives for the final product.

Component power supplies for general use should comply with the requirements in IEC60950, EN60950 and UL60950 "*Safety of information technology equipment*". There are other more product related standards, e.g. IEEE802.3af "Ethernet LAN/MAN Data terminal equipment power", and ETS300132-2 "Power supply interface at the input to telecommunications equipment; part 2: DC", but all of these standards are based on IEC/EN/UL60950 with regards to safety.

Flex DC/DC converters and DC/DC regulators are UL60950 recognized and certified in accordance with EN60950.

The flammability rating for all construction parts of the products meets requirements for V-0 class material according to IEC 60695-11-10.

The products should be installed in the end-use equipment, in accordance with the requirements of the ultimate application. Normally the output of the DC/DC converter is considered as SELV (Safety Extra Low Voltage) and the input source must be isolated by minimum Double or Reinforced Insulation from the primary circuit (AC mains) in

accordance with IEC/EN/UL60950.

### Isolated DC/DC converters

It is recommended that a slow blow fuse with a rating twice the maximum input current per selected product be used at the input of each DC/DC converter. If an input filter is used in the circuit the fuse should be placed in front of the input filter.

In the rare event of a component problem in the input filter or in the DC/DC converter that imposes a short circuit on the input source, this fuse will provide the following functions:

- Isolate the faulty DC/DC converter from the input power source so as not to affect the operation of other parts of the system.
- Protect the distribution wiring from excessive current and power loss thus preventing hazardous overheating.

The galvanic isolation is verified in an electric strength test. The test voltage ( $V_{iso}$ ) between input and output is 1500 Vdc or 2250 Vdc for 60 seconds (refer to product specification).

Leakage current is less than 1  $\mu$ A at nominal input voltage.

### 24 V DC systems

The input voltage to the DC/DC converter is SELV (Safety Extra Low Voltage) and the output remains SELV under normal and abnormal operating conditions.

### 48 and 60 V DC systems

If the input voltage to the DC/DC converter is 75 Vdc or less, then the output remains SELV (Safety Extra Low Voltage) under normal and abnormal operating conditions.

Single fault testing in the input power supply circuit should be performed with the DC/DC converter connected to demonstrate that the input voltage does not exceed 75 Vdc.

If the input power source circuit is a DC power system, the source may be treated as a TNV2 circuit and testing has demonstrated compliance with SELV limits and isolation requirements equivalent to Basic Insulation in accordance with IEC/EN/UL60950.

### Non-isolated DC/DC regulators

The input voltage to the DC/DC regulator is SELV (Safety Extra Low Voltage) and the output remains SELV under normal and abnormal operating conditions.



**D?6 ( \$\$\$\$ series Direct Converters**  
 Input 36-72 V, Output up to 30 A / 125 W

EN/LZT 146 420 R4A October 2017

© Flex

**Absolute Maximum Ratings**

Characteristics		min	typ	max	Unit
$T_{P1}$	Operating Temperature (see Thermal Consideration section)	-40		+125	°C
$T_S$	Storage temperature	-55		+110	°C
$V_I$	Input voltage	-0.5		+80	V
$V_{iso}$	Isolation voltage (input to output test voltage)			2250	Vdc
$V_{tr}$	Input voltage transient ( $t_p$ 100 ms)			100	V
$V_{RC}$	Remote Control pin voltage (see Operating Information section)	Positive logic option		40	V
		Negative logic option	0	40	V
$V_{adj}$	Adjust pin voltage (see Operating Information section)	-0.5		$2xV_{oi}$	V

Stress in excess of Absolute Maximum Ratings may cause permanent damage. Absolute Maximum Ratings, sometimes referred to as no destruction limits, are normally tested with one parameter at a time exceeding the limits in the Electrical Specification. If exposed to stress above these limits, function and performance may degrade in an unspecified manner.

**Fundamental Circuit Diagram**

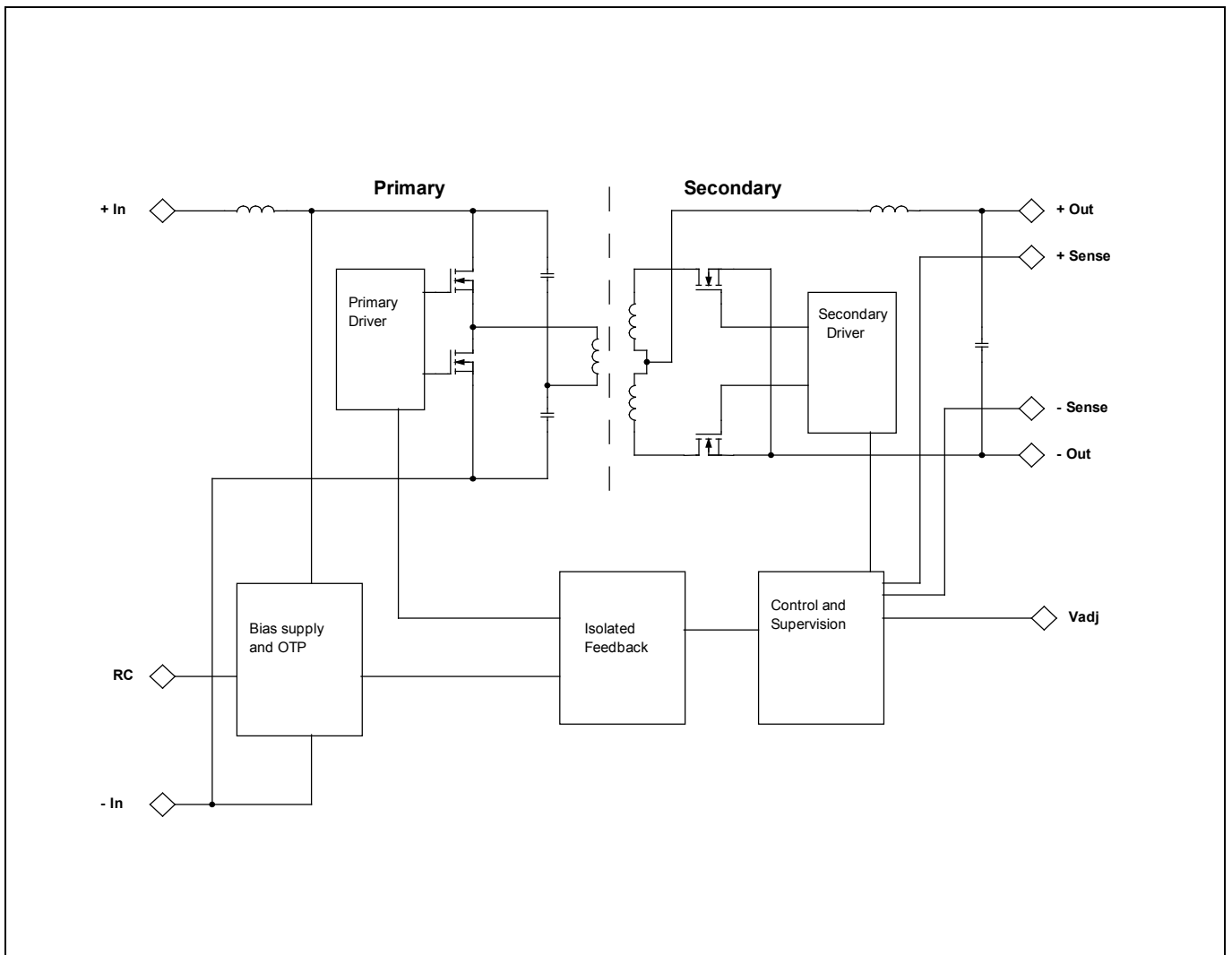



**D?6 ( \$\$\$\$ series Direct Converters**  
Input 36-72 V, Output up to 30 A / 125 W

EN/LZT 146 420 R4A October 2017

© Flex

### 3.3V, 30A /99W Electrical Specification

**PKB 4910A PI**
 $T_{P1} = -30$  to  $+90^{\circ}\text{C}$ ,  $V_I = 36$  to  $72$  V, sense pins connected to output pins unless otherwise specified under Conditions.

 Typical values given at:  $T_{P1} = +25^{\circ}\text{C}$ ,  $V_I = 53$  V,  $I_O = \text{max}$ , unless otherwise specified under Conditions.

 Additional  $C_{in} = 33$   $\mu\text{F}$ . See Operating Information section for selection of capacitor types.

Characteristics		Conditions	min	typ	max	Unit
$V_I$	Input voltage range		36		72	V
$V_{loff}$	Turn-off input voltage	Decreasing input voltage	30	31	32	V
$V_{lon}$	Turn-on input voltage	Increasing input voltage	33	34	35	V
$C_I$	Internal input capacitance			5.7		$\mu\text{F}$
$P_O$	Output power		0		99	W
$\eta$	Efficiency	50 % of max $I_O$		92.4		%
		max $I_O$		91.0		
		50 % of max $I_O$ , $V_I = 48$ V		92.7		
		max $I_O$ , $V_I = 48$ V		91.0		
$P_d$	Power Dissipation	max $I_O$		9.8	14	W
$P_{li}$	Input idling power	$I_O = 0$ A, $V_I = 53$ V		1.8		W
$P_{RC}$	Input standby power	$V_I = 53$ V (turned off with RC)		0.1		W
$f_s$	Switching frequency	0-100 % of max $I_O$	162	180	198	kHz

$V_{Oi}$	Output voltage initial setting and accuracy	$T_{P1} = +25^{\circ}\text{C}$ , $V_I = 53$ V, $I_O = 30$ A	3.23	3.30	3.37	V
$V_O$	Output adjust range	See operating information (see Note 1)	2.64		3.63	V
	Output voltage tolerance band	0-100 % of max $I_O$	3.2		3.4	V
	Line regulation	max $I_O$		$\pm 3$	$\pm 10$	mV
	Load regulation	$V_I = 53$ V, 0-100 % of max $I_O$		$\pm 5$	$\pm 10$	mV
$V_{tr}$	Load transient voltage deviation	$V_I = 53$ V, Load step 25-75-25 % of max $I_O$ , $di/dt = 1$ A/ $\mu\text{s}$		$\pm 200$	$\pm 350$	mV
$t_{tr}$	Load transient recovery time	See Note 2		40		$\mu\text{s}$
$t_r$	Ramp-up time (from 10-90 % of $V_{Oi}$ )	0-100 % of max $I_O$		8		ms
$t_s$	Start-up time (from $V_I$ connection to 90 % of $V_{Oi}$ )			12		ms
$t_f$	$V_I$ shut-down fall time (from $V_I$ off to 10 % of $V_O$ )	max $I_O$		50		$\mu\text{s}$
		$I_O = 0$ A		5		s
$t_{RC}$	RC start-up time	max $I_O$		12		ms
	RC shut-down fall time (from RC off to 10 % of $V_O$ )	max $I_O$		37		$\mu\text{s}$
		$I_O = 0$ A		5		s
$I_O$	Output current		0		30	A
$I_{lim}$	Current limit threshold	$T_{P1} < \text{max } T_{P1}$		40		A
$I_{sc}$	Short circuit current	$T_{P1} = 25^{\circ}\text{C}$ , see Note 3		45		A
$C_{out}$	Recommended Capacitive Load	$T_{P1} = 25^{\circ}\text{C}$ , see Note 4	0		3000	$\mu\text{F}$
$V_{Oac}$	Output ripple & noise	See ripple & noise section, max $I_O$ , $V_{Oi}$		60	120	mVp-p
OVP	Over voltage protection	$T_{P1} = +25^{\circ}\text{C}$ , $V_I = 53$ V, 0-100 % of max $I_O$	3.8	4.3	4.8	V

 Note 1: At trim-up, the minimum  $V_{in}/V_{out}$  ratio must be kept, i.e. 5 % trim up require  $V_{in} > 37.8$  V

 Note 2: 3000  $\mu\text{F}$ ; ESR value 5 m $\Omega$ 

 Note 3: Constant current  $V_O < 0.5$  V

Note 4: See Operating Information Section



**D?6 ( \$\$\$5 series Direct Converters**  
 Input 36-72 V, Output up to 30 A / 125 W

EN/LZT 146 420 R4A October 2017

© Flex

**3.3V, 30A /99W Typical Characteristics**

**PKB 4910A PI**

**Efficiency**

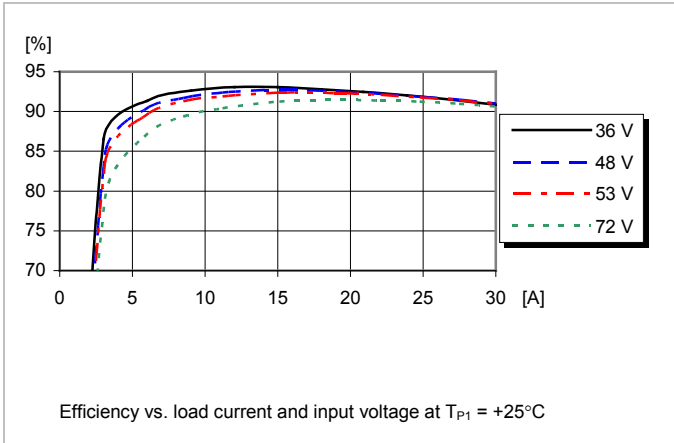

**Power Dissipation**

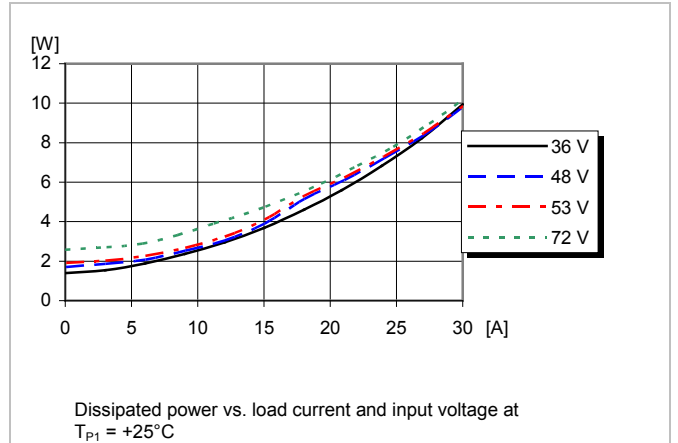

**Output Characteristics**

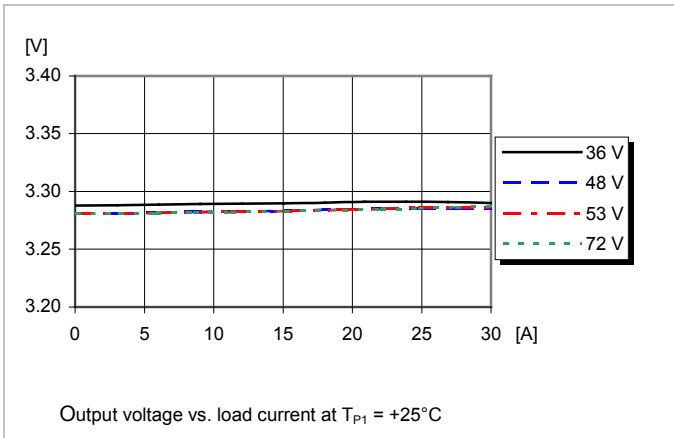

**Current Limit Characteristics**

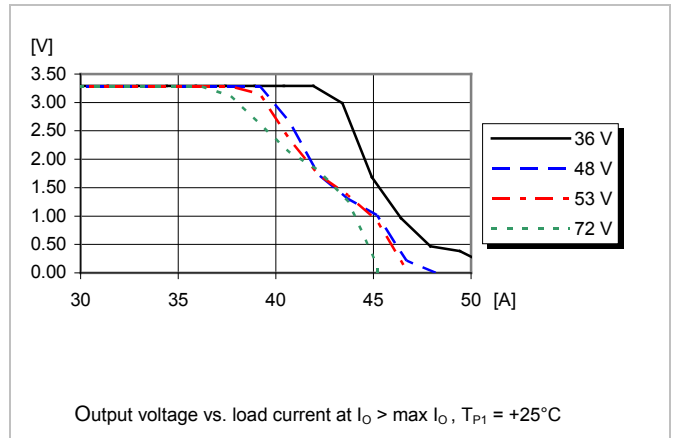



**D?6 ( \$\$\$\$ series Direct Converters**  
 Input 36-72 V, Output up to 30 A / 125 W

EN/LZT 146 420 R4A October 2017

© Flex

**3.3V, 30A /99W Typical Characteristics**

**PKB 4910A PI**

**Start-up**

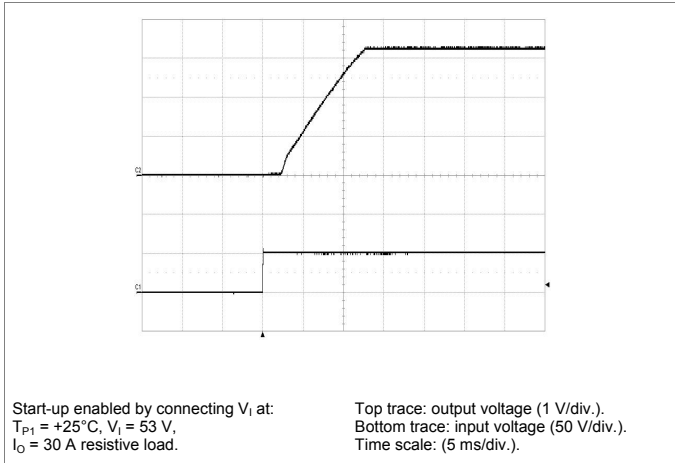

**Shut-down**

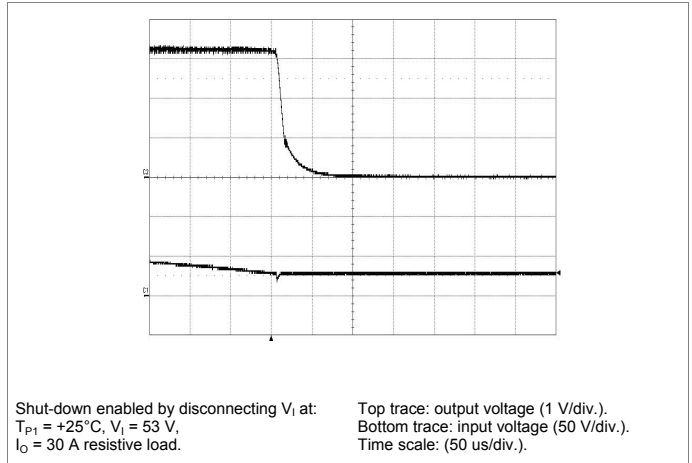

**Output Ripple & Noise**

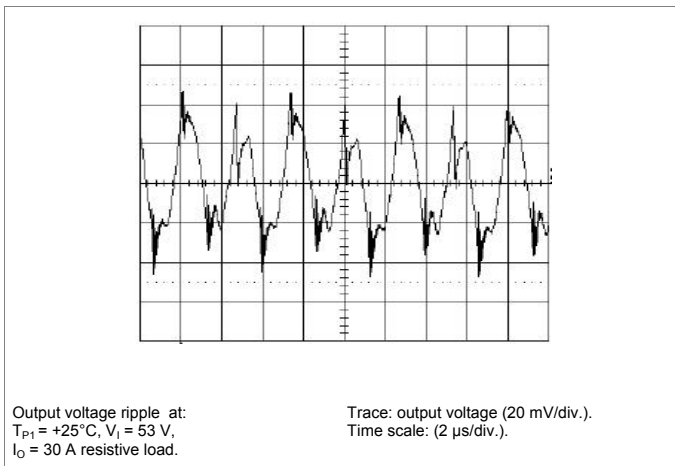

**Output Load Transient Response**

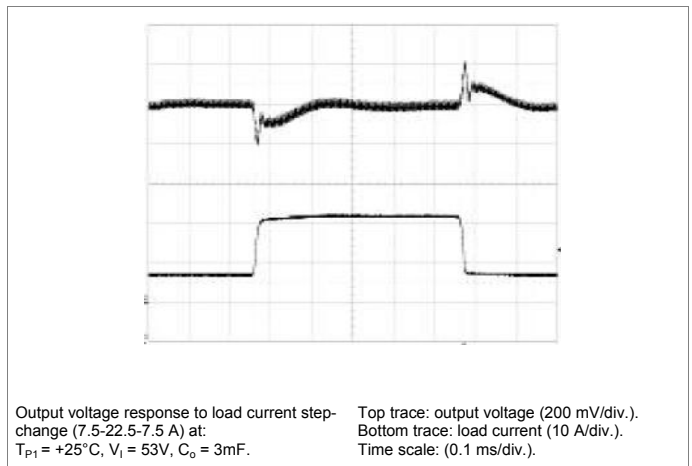

**Output Voltage Adjust (see operating information)**

**Passive adjust**

The resistor value for an adjusted output voltage is calculated by using the following equations:

Output Voltage Adjust Upwards, Increase:

$$R_{adj} = \left( \frac{5.1 \times 3.30(100 + \Delta\%)}{1.225 \times \Delta\%} - \frac{510}{\Delta\%} - 10.2 \right) \text{ k}\Omega$$

Example: Increase 4% => V<sub>out</sub> = 3.432 Vdc

$$\left( \frac{5.1 \times 3.30(100 + 4)}{1.225 \times 4} - \frac{510}{4} - 10.2 \right) \text{ k}\Omega = 220 \text{ k}\Omega$$

Output Voltage Adjust Downwards, Decrease:

$$R_{adj} = 5.11 \times \left( \frac{100}{\Delta\%} - 2 \right) \text{ k}\Omega$$

**Active adjust**

The output voltage may be adjusted using a {current/voltage} applied to the V<sub>adj</sub> pin. This {current/voltage} is calculated by using the following equations:

$$V_{adj} = \left( 1.225 + 2.45 \times \frac{V_{desired} - 3.30}{3.30} \right) \text{ V}$$

Example: Upwards => 3.50 V

$$\left( 1.225 + 2.45 \times \frac{3.50 - 3.30}{3.30} \right) \text{ V} = 1.37 \text{ V}$$



**D76 ( \$\$\$5 series Direct Converters**  
 Input 36-72 V, Output up to 30 A / 125 W

EN/LZT 146 420 R4A October 2017

© Flex

**3.3V, 30A /99W Typical Characteristics**

**PKB 4910A PI**

**Output Current Derating – Open frame**

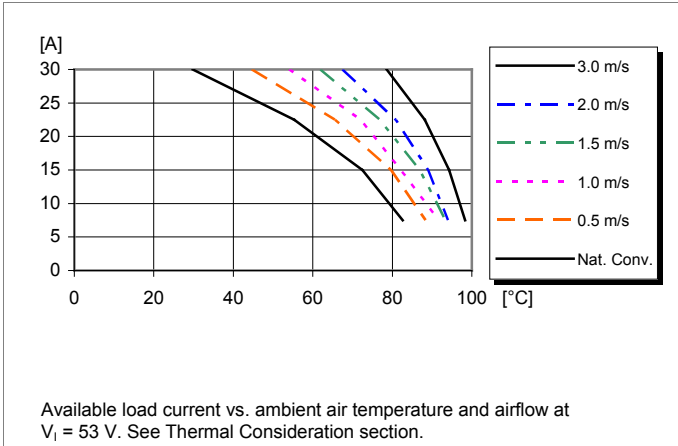



**D?6 ( \$\$\$\$ series Direct Converters**  
Input 36-72 V, Output up to 30 A / 125 W

EN/LZT 146 420 R4A October 2017

© Flex

**5.0V, 25A /125W Electrical Specification****PKB 4111A PI**

$T_{P1} = -30$  to  $+90^{\circ}\text{C}$ ,  $V_I = 36$  to  $72$  V, sense pins connected to output pins unless otherwise specified under Conditions.

Typical values given at:  $T_{P1} = +25^{\circ}\text{C}$ ,  $V_I = 53$  V,  $I_O = \text{max}$ , unless otherwise specified under Conditions.

Additional  $C_{in} = 33$   $\mu\text{F}$ . See Operating Information section for selection of capacitor types.

Characteristics		Conditions	min	typ	max	Unit
$V_I$	Input voltage range		36		72	V
$V_{loff}$	Turn-off input voltage	Decreasing input voltage	30	31	32	V
$V_{lon}$	Turn-on input voltage	Increasing input voltage	33	34	35	V
$C_I$	Internal input capacitance			5.7		$\mu\text{F}$
$P_O$	Output power		0		125	W
$\eta$	Efficiency	50 % of max $I_O$		93.3		%
		max $I_O$		92.6		
		50 % of max $I_O$ , $V_I = 48$ V		93.5		
		max $I_O$ , $V_I = 48$ V		92.6		
$P_d$	Power Dissipation	max $I_O$		10.0	13.5	W
$P_{li}$	Input idling power	$I_O = 0$ A, $V_I = 53$ V		2.4		W
$P_{RC}$	Input standby power	$V_I = 53$ V (turned off with RC)		0.1		W
$f_s$	Switching frequency	0-100 % of max $I_O$	162	180	196	kHz

$V_{Oi}$	Output voltage initial setting and accuracy	$T_{P1} = +25^{\circ}\text{C}$ , $V_I = 53$ V, $I_O = 25$ A	4.90	5.00	5.10	V
$V_O$	Output adjust range	See operating information (see Note 1)	4.0		5.5	V
	Output voltage tolerance band	0-100 % of max $I_O$	4.85		5.15	V
	Line regulation	max $I_O$		$\pm 3$	$\pm 10$	mV
	Load regulation	$V_I = 53$ V, 0-100 % of max $I_O$		$\pm 3$	$\pm 10$	mV
$V_{tr}$	Load transient voltage deviation	$V_I = 53$ V, Load step 25-75-25 % of max $I_O$ , $di/dt = 1$ A/ $\mu\text{s}$		$\pm 160$	$\pm 250$	mV
$t_{tr}$	Load transient recovery time	See Note 2		50		$\mu\text{s}$
$t_r$	Ramp-up time (from 10-90 % of $V_{Oi}$ )	0-100 % of max $I_O$		9		ms
$t_s$	Start-up time (from $V_I$ connection to 90 % of $V_{Oi}$ )			13		ms
$t_f$	$V_I$ shut-down fall time (from $V_I$ off to 10 % of $V_O$ )	max $I_O$		0.5		ms
		$I_O = 0$ A		5		s
$t_{RC}$	RC start-up time	max $I_O$		13		ms
	RC shut-down fall time (from RC off to 10 % of $V_O$ )	max $I_O$		0.3		ms
		$I_O = 0$ A		5		s
$I_O$	Output current		0		25	A
$I_{lim}$	Current limit threshold	$T_{P1} < \text{max } T_{P1}$		32		A
$I_{sc}$	Short circuit current	$T_{P1} = 25^{\circ}\text{C}$ , see Note 3		38		A
$C_{out}$	Recommended Capacitive Load	$T_{P1} = 25^{\circ}\text{C}$ , see Note 4	0		2500	$\mu\text{F}$
$V_{Oac}$	Output ripple & noise	See ripple & noise section, max $I_O$ , $V_{Oi}$		60	120	mVp-p
OVP	Over voltage protection	$T_{P1} = +25^{\circ}\text{C}$ , $V_I = 53$ V, 0-100 % of max $I_O$		6.3	7.4	V

Note 1: At trim-up, the minimum  $V_{in}/V_{out}$  ratio must be kept, i.e. 5 % trim up require  $V_{in} > 37.8$  V

Note 2: 2500 $\mu\text{F}$ ; ESR value 10m $\Omega$

Note 3: Constant current  $V_O < 0.5$  V

Note 4: See Operating Information Section



**D?6 ( \$\$\$5 series Direct Converters**  
 Input 36-72 V, Output up to 30 A / 125 W

EN/LZT 146 420 R4A October 2017

© Flex

**5.0V, 25A /125W Typical Characteristics**

**PKB 4111A PI**

**Efficiency**

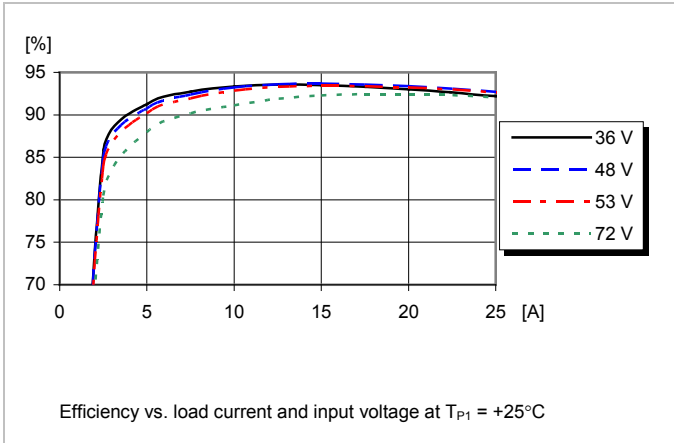

**Power Dissipation**

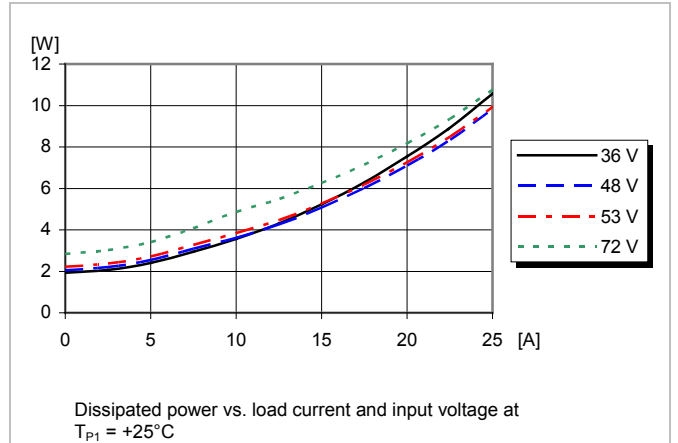

**Output Characteristics**

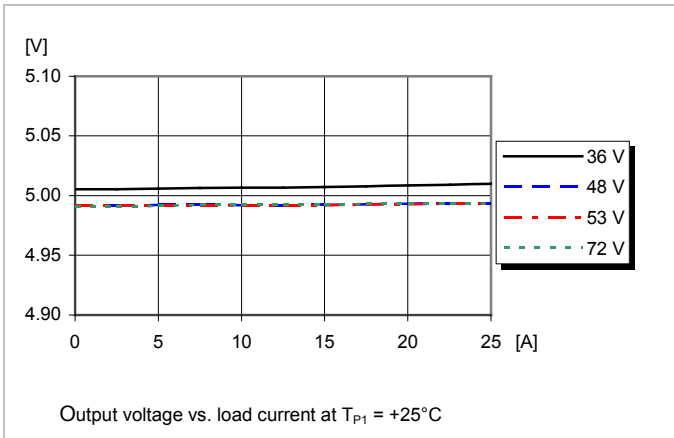

**Current Limit Characteristics**

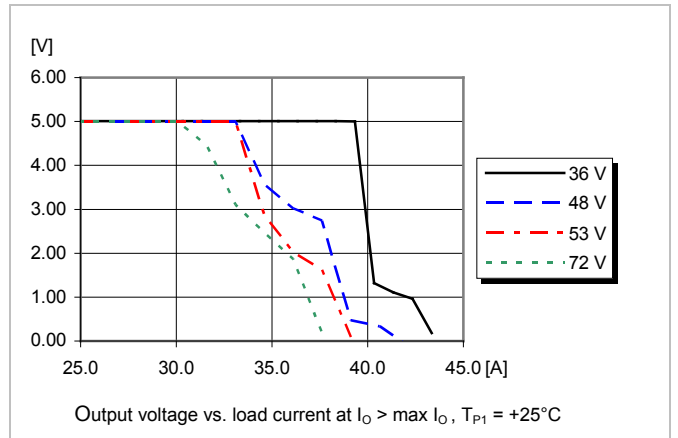



**D?6 ( \$\$\$5 series Direct Converters**  
 Input 36-72 V, Output up to 30 A / 125 W

EN/LZT 146 420 R4A October 2017

© Flex

**5.0V, 25A /125W Typical Characteristics**

**PKB 4111A PI**

**Start-up**

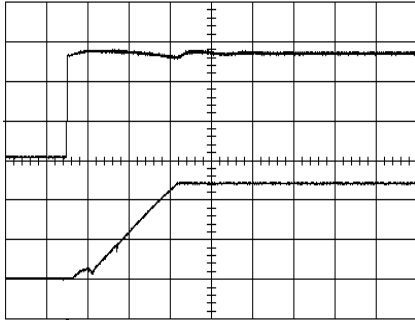

Start-up enabled by connecting  $V_1$  at:  
 $T_{P1} = +25^{\circ}\text{C}$ ,  $V_1 = 53\text{ V}$ ,  
 $I_O = 25\text{ A}$  resistive load.

Top trace: input voltage (20 V/div.),  
 Bottom trace: output voltage (2 V/div.).  
 Time scale: (5 ms/div.).

**Shut-down**

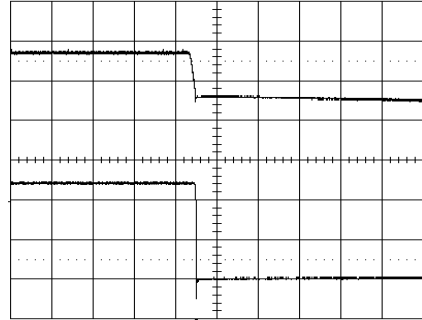

Shut-down enabled by disconnecting  $V_1$  at:  
 $T_{P1} = +25^{\circ}\text{C}$ ,  $V_1 = 53\text{ V}$ ,  
 $I_O = 25\text{ A}$  resistive load.

Top trace: input voltage (20 V/div.),  
 Bottom trace: output voltage (2 V/div.).  
 Time scale: (5 ms/div.).

**Output Ripple & Noise**

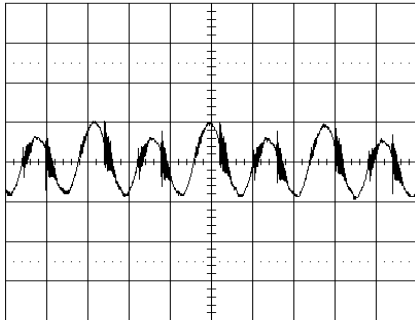

Output voltage ripple at:  
 $T_{P1} = +25^{\circ}\text{C}$ ,  $V_1 = 53\text{ V}$ ,  
 $I_O = 25\text{ A}$  resistive load.

Trace: output voltage (20 mV/div.).  
 Time scale: (2  $\mu\text{s}$ /div.).

**Output Load Transient Response**

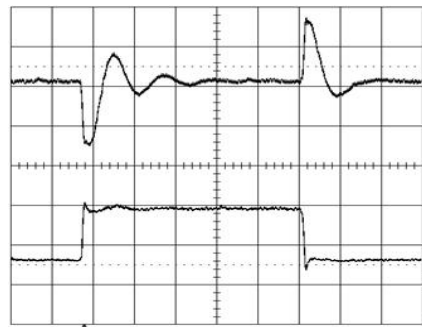

Output voltage response to load current step-change (6.25-18.75-6.25 A) at:  
 $T_{P1} = +25^{\circ}\text{C}$ ,  $V_1 = 53\text{ V}$ .

Top trace: output voltage (100 mV/div.).  
 Bottom trace: load current (10 A/div.).  
 Time scale: (0.2 ms/div.).

**Output Voltage Adjust (see operating information)**

**Passive adjust**

The resistor value for an adjusted output voltage is calculated by using the following equations:

Output Voltage Adjust Upwards, Increase:

$$R_{adj} = \left( \frac{5.10 \times 5.00(100 + \Delta\%) - 510}{1.225 \times \Delta\%} - 10.2 \right) \text{ k}\Omega$$

Example: Increase 4% =>  $V_{out} = 5.2\text{ Vdc}$

$$\left( \frac{5.10 \times 5.00(100 + 4)}{1.225 \times 4} - 10.2 \right) \text{ k}\Omega = 404 \text{ k}\Omega$$

Output Voltage Adjust Downwards, Decrease:

$$R_{adj} = 5.11 \times \left( \frac{100}{\Delta\%} - 2 \right) \text{ k}\Omega$$

**Active adjust**

The output voltage may be adjusted using a {current/voltage} applied to the  $V_{adj}$  pin. This {current/voltage} is calculated by using the following equations:

$$V_{adj} = \left( 1.225 + 2.45 \times \frac{V_{desired} - 5.00}{5.00} \right) \text{ V}$$

Example: Upwards => 5.30 V

$$\left( 1.225 + 2.45 \times \frac{5.30 - 5.00}{5.00} \right) \text{ V} = 1.37 \text{ V}$$



**D76 (D765 series Direct Converters**  
 Input 36-72 V, Output up to 30 A / 125 W

EN/LZT 146 420 R4A October 2017

© Flex

**5.0V, 25A / 125W Typical Characteristics**

**PKB 4111A PI**

**Output Current Derating – Open frame**

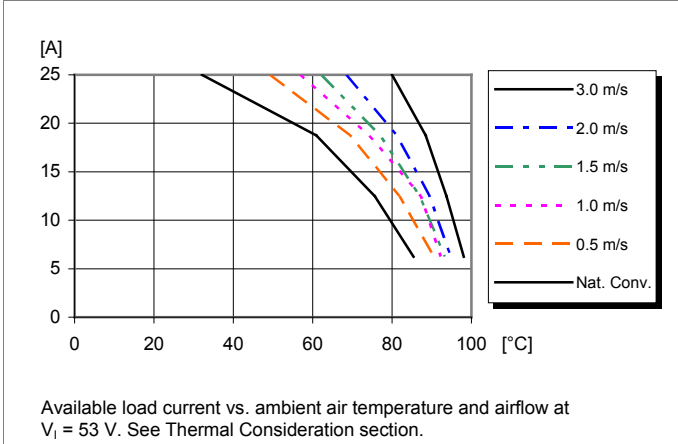



**D?6 ( \$\$\$5 series Direct Converters**  
 Input 36-72 V, Output up to 30 A / 125 W

EN/LZT 146 420 R4A October 2017

© Flex

**EMC Specification**

Conducted EMI measured according to EN55022, CISPR 22 and FCC part 15J (see test set-up). See Design Note 009 for further information. The fundamental switching frequency is 180 kHz for PKB 4910A PINB @  $V_i = 53$  V, max  $I_o$ .

**Conducted EMI Input terminal value (typ)**

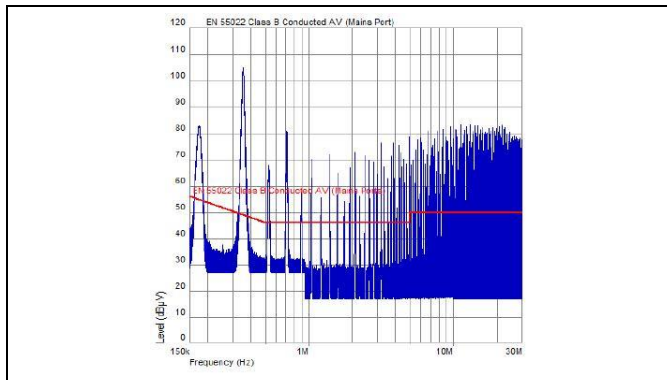

EMI without filter

**External filter (class B)**

Required external input filter in order to meet class B in EN 55022, CISPR 22 and FCC part 15J.

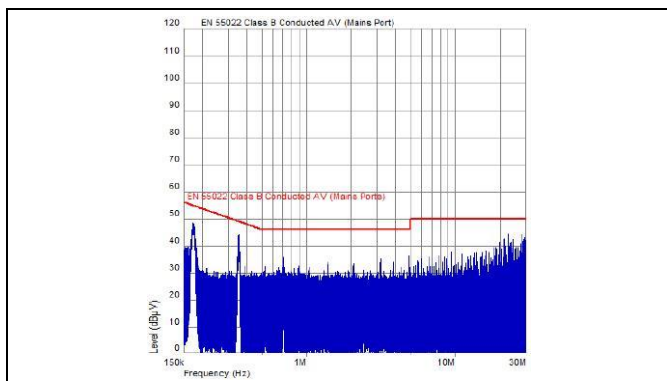
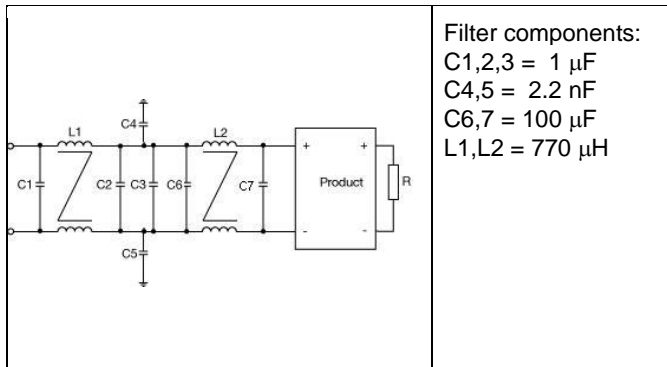

EMI with filter

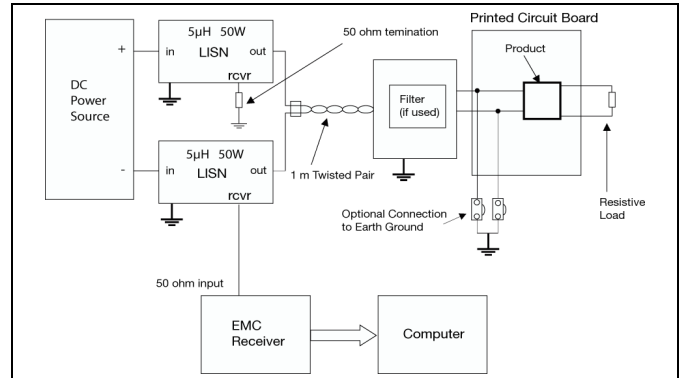

Test set-up

**Layout recommendations**

The radiated EMI performance of the Product will depend on the PCB layout and ground layer design. It is also important to consider the stand-off of the product. If a ground layer is used, it should be connected to the output of the product and the equipment ground or chassis.

A ground layer will increase the stray capacitance in the PCB and improve the high frequency EMC performance.

**Output ripple and noise**

Output ripple and noise measured according to figure below. See Design Note 022 for detailed information.

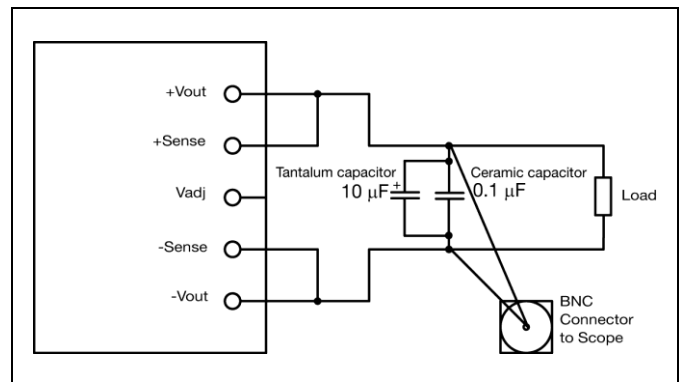

Output ripple and noise test setup

**D?6 ( \$\$\$\$ series Direct Converters**  
**Input 36-72 V, Output up to 30 A / 125 W**

EN/LZT 146 420 R4A October 2017

© Flex

## Operating information

### Input Voltage

The input voltage range 36 to 72Vdc meets the requirements of the European Telecom Standard ETS 300 132-2 for normal input voltage range in –48 and –60 Vdc systems, -40.5 to -57.0 V and –50.0 to -72 V respectively.

At input voltages exceeding 72 V, the power loss will be higher than at normal input voltage and  $T_{P1}$  must be limited to absolute max +125°C. The absolute maximum continuous input voltage is 80 Vdc.

### Turn-off Input Voltage

The products monitor the input voltage and will turn on and turn off at predetermined levels.

The minimum hysteresis between turn on and turn off input voltage is 2V.

### Remote Control (RC)

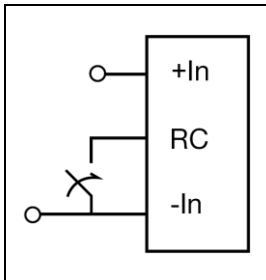

The products are fitted with a remote control function referenced to the primary negative input connection (-In), with negative and positive logic options available. The RC function allows the product to be turned on/off by an external device like a semiconductor or mechanical switch. The RC pin has an internal pull up resistor to +In.

The maximum required sink current is 1 mA. When the RC pin is left open, the voltage generated on the RC pin is 5 – 7 V or 10-13V for “P” option. The standard product is provided with “negative logic” remote control and will be off until the RC pin is connected to the -In. To turn on the product the voltage between RC pin and -In should be less than 1V. To turn off the converter the RC pin should be left open, or connected to a voltage higher than 4.5 V referenced to -In. In situations where it is desired to have the product to power up automatically without the need for control signals or a switch, the RC pin can be wired directly to -In.

The second option is “positive logic” remote control, which can be ordered by adding the suffix “P” to the end of the part number. When the RC pin is left open, the product starts up automatically when the input voltage is applied. Turn off is achieved by connecting the RC pin to the -In. To ensure safe turn off the voltage difference between RC pin and the -In pin shall be less than 1V. The product will restart automatically when this connection is opened.

See Design Note 021 for detailed information.

### Input and Output Impedance

The impedance of both the input source and the load will interact with the impedance of the product. It is important that the input source has low characteristic impedance. The products are designed for stable operation without external

capacitors connected to the input or output. The performance in some applications can be enhanced by addition of external capacitance as described under External Decoupling Capacitors.

If the input voltage source contains significant inductance, the addition of a 100  $\mu$ F capacitor across the input of the product will ensure stable operation. The capacitor is not required when powering the product from an input source with an inductance below 10  $\mu$ H. The minimum required capacitance value depends on the output power and the input voltage. The higher output power the higher input capacitance is needed.

### External Decoupling Capacitors

When powering loads with significant dynamic current requirements, the voltage regulation at the point of load can be improved by addition decoupling capacitors at the load with >10% of the maximum recommended value found in the electrical specification.

The most effective technique is to locate low ESR ceramic and electrolytic capacitors as close to the load as possible, using several parallel capacitors to lower the effective ESR. The ceramic capacitors will handle high-frequency dynamic load changes while the electrolytic capacitors are used to handle low frequency dynamic load changes. It is equally important to use low resistance and low inductance PCB layouts and cabling.

External decoupling capacitors will become part of the product’s control loop. The control loop is optimized for a wide range of external capacitance and the maximum recommended value that could be used without any additional analysis is found in the Electrical specification.

The ESR of the capacitors is a very important parameter. Stable operation is guaranteed with a verified ESR value of >10 m $\Omega$  across the output connections.

For further information please contact your local Flex Power Modules representative.

### Output Voltage Adjust ( $V_{adj}$ )

The products have an Output Voltage Adjust pin ( $V_{adj}$ ). This pin can be used to adjust the output voltage above or below Output voltage initial setting.

When increasing the output voltage, the voltage at the output pins (including any remote sense compensation ) must be kept below the threshold of the over voltage protection, (OVP) to prevent the product from shutting down. At increased output voltages the maximum power rating of the product remains the same, and the max output current must be decreased correspondingly.

To increase the voltage the resistor should be connected between the  $V_{adj}$  pin and +Sense pin. The resistor value of the Output voltage adjust function is according to information given under the Output section for the respective product. To decrease the output voltage, the resistor should be connected between the  $V_{adj}$  pin and –Sense pin.



**D?6 ( \$\$\$\$ series Direct Converters**  
Input 36-72 V, Output up to 30 A / 125 W

EN/LZT 146 420 R4A October 2017

© Flex

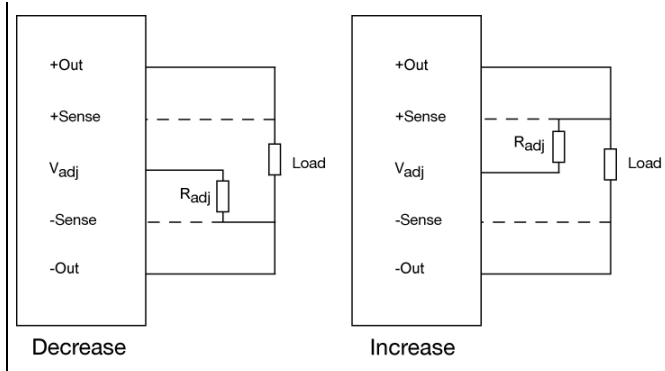

### Pre-bias Start-up

The products do not support pre-biased start up with zero reverse current.

### Thermal Consideration

#### General

The products are designed to operate in different thermal environments and sufficient cooling must be provided to ensure reliable operation.

### Parallel Operation

Two products may be paralleled for redundancy if the total power is equal or less than  $P_{O\ max}$ . It is not recommended to parallel the products without using external current sharing circuits.

See Design Note 006 for detailed information.

### Remote Sense

The products have remote sense that can be used to compensate for voltage drops between the output and the point of load. The sense traces should be located close to the PCB ground layer to reduce noise susceptibility. The remote sense circuitry will compensate for up to 10% voltage drop between output pins and the point of load.

If the remote sense is not needed +Sense should be connected to +Out and -Sense should be connected to -Out.

### Over Temperature Protection (OTP)

The products are protected from thermal overload by an internal over temperature shutdown circuit.

When  $T_{P1}$  as defined in thermal consideration section exceeds  $140^{\circ}\text{C}$  the product will shut down. The product will make continuous attempts to start up (non-latching mode) and resume normal operation automatically when the temperature has dropped  $>15^{\circ}\text{C}$  below the temperature threshold.

### Over Voltage Protection (OVP)

The products have output over voltage protection that will shut down the product in over voltage conditions. The product will make continuous attempts to start up (non-latching mode) and resume normal operation automatically after removal of the over voltage condition.

### Over Current Protection (OCP)

The products include current limiting circuitry for protection at continuous overload. The output voltage will decrease towards zero for output currents in excess of max output current ( $\text{max } I_o$ ). The product will resume normal operation after removal of the overload. The load distribution should be designed for the maximum output short circuit current specified.

Cooling is achieved mainly by conduction, from the pins to the host board, and convection, which is dependant on the airflow across the product. Increased airflow enhances the cooling of the product. The Output Current Derating graph found in the Output section for each model provides the available output current vs. ambient air temperature and air velocity at  $V_i = 53\ \text{V}$ .

The product is tested on a  $254 \times 254\ \text{mm}$ ,  $35\ \mu\text{m}$  (1 oz), 16-layer test board mounted vertically in a wind tunnel with a cross-section of  $608 \times 203\ \text{mm}$ .

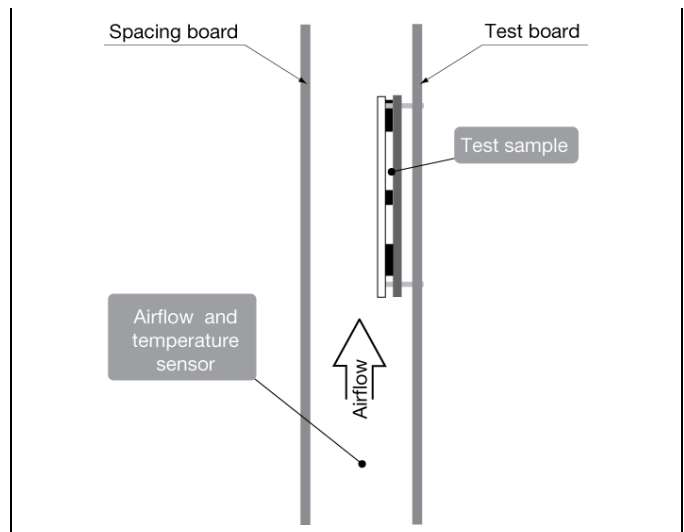



**D?6 ( \$\$\$5 series Direct Converters**  
 Input 36-72 V, Output up to 30 A / 125 W

EN/LZT 146 420 R4A October 2017

© Flex

**Definition of product operating temperature**

The product operating temperatures is used to monitor the temperature of the product, and proper thermal conditions can be verified by measuring the temperature at positions P1, P2 and P3. The temperature at these positions ( $T_{P1}$ ,  $T_{P2}$ ,  $T_{P3}$ ) should not exceed the maximum temperatures in the table below. The number of measurement points may vary with different thermal design and topology. Temperatures above maximum  $T_{P1}$ , measured at the reference point P1 are not allowed and may cause permanent damage.

Position	Description	Max Temp.
P1	Mosfet pin	$T_{P1}=130^{\circ}\text{C}$
P2	Opto coupler (case)	$T_{P2}=110^{\circ}\text{C}$
P3	Transformer	$T_{P3}=130^{\circ}\text{C}$

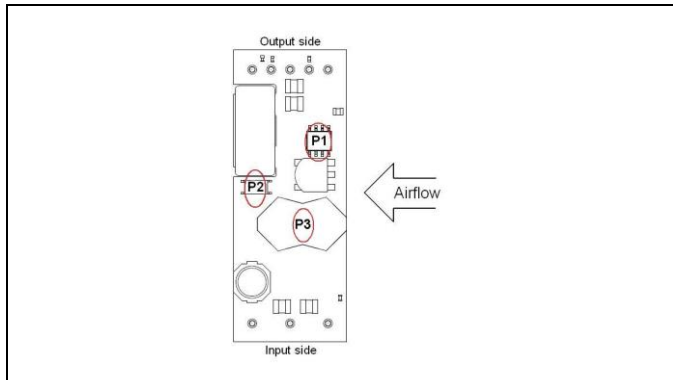

Open frame

**Connections**

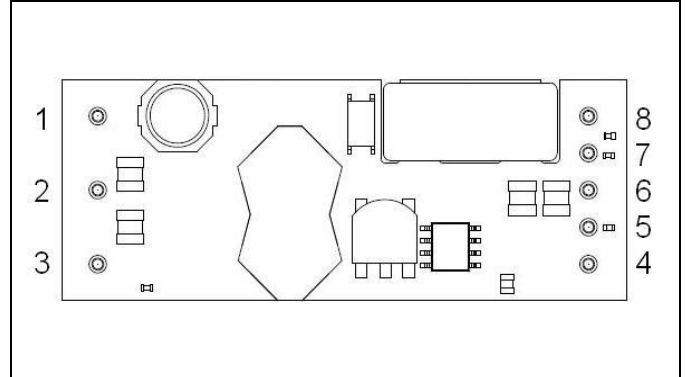

Pin	Designation	Function
1	+In	Positive input
2	RC	Remote control
3	-In	Negative input
4	-Out	Negative output
5	-Sen	Negative remote sense
6	Vadj	Output voltage adjust
7	+Sen	Positive remote sense
8	+Out	Positive output



**D?6 ( \$\$\$\$ series Direct Converters**  
 Input 36-72 V, Output up to 30 A / 125 W

EN/LZT 146 420 R4A October 2017

© Flex

**Mechanical Information - SMD, Open Frame Version**

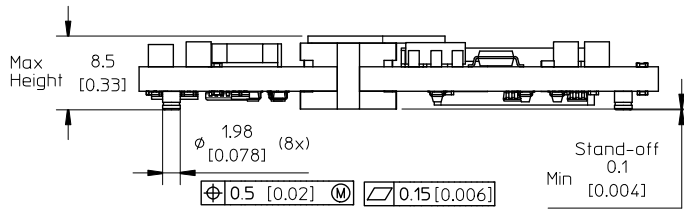

TOP VIEW

Pin positions according to recommended footprint

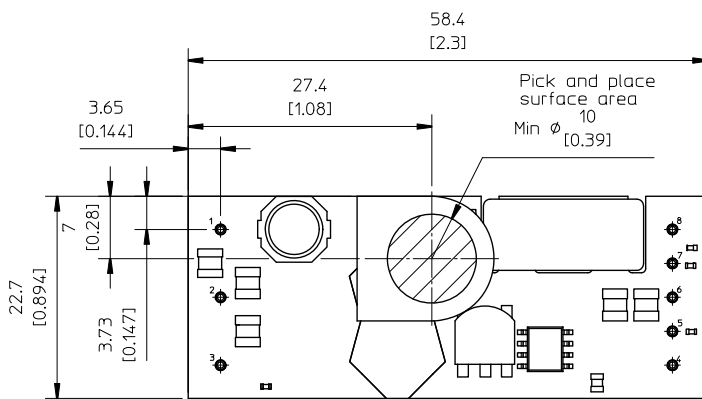
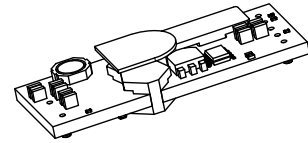

RECOMMENDED FOOTPRINT  
 TOP VIEW

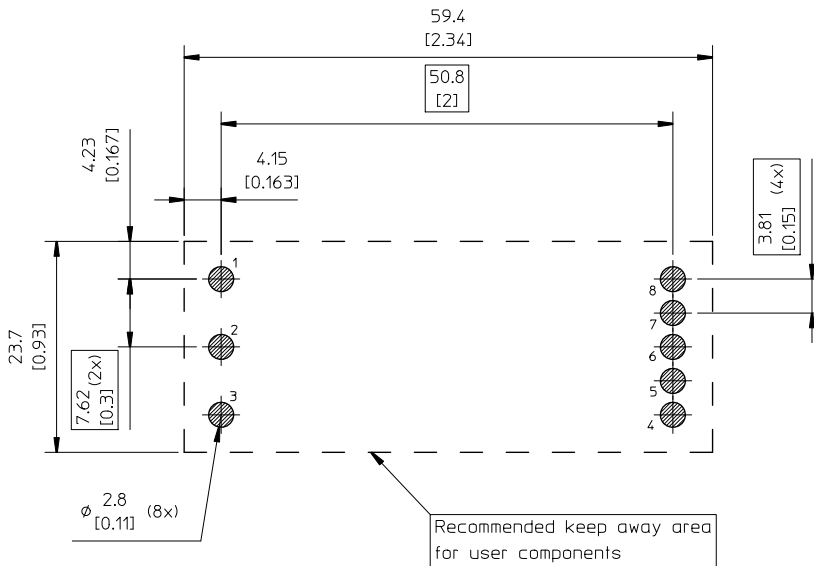
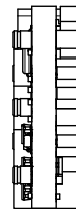

Pins:  
 Material: Copper alloy  
 Plating: 0.1 µm Gold (Au) over 2 µm Nickel (Ni)

Weight: typical 20 g

All dimensions in mm [inch].  
 Tolerances unless specified:  
 x.x ±0.5 mm [0.02]  
 x.xx±0.25 mm [0.01]  
 (not applied on footprint or typical values)



All component placements – whether shown as physical components or symbolical outline – are for reference only and are subject to change throughout the product's life cycle, unless explicitly described and dimensioned in this drawing.



**D?6 ( \$\$\$\$ series Direct Converters**  
 Input 36-72 V, Output up to 30 A / 125 W

EN/LZT 146 420 R4A October 2017

© Flex

**Mechanical Information- Hole Mount, Open Frame Version**

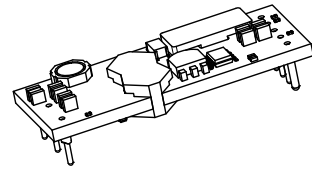
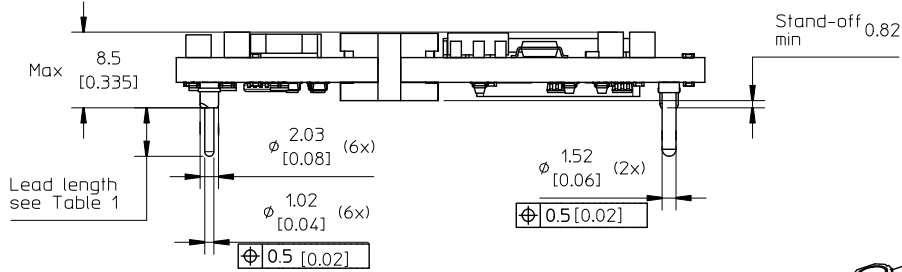

TOP VIEW

Pin positions according to recommended footprint

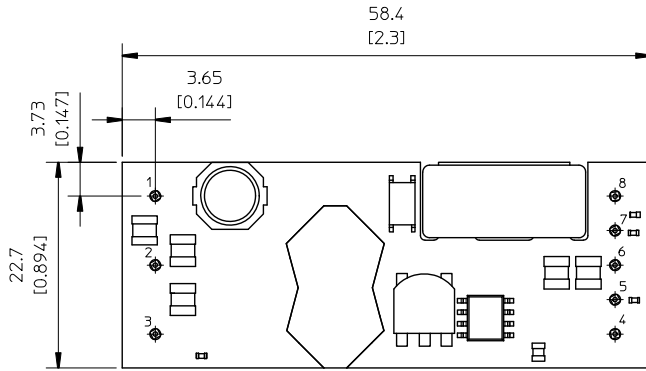

RECOMMENDED FOOTPRINT  
 TOP VIEW

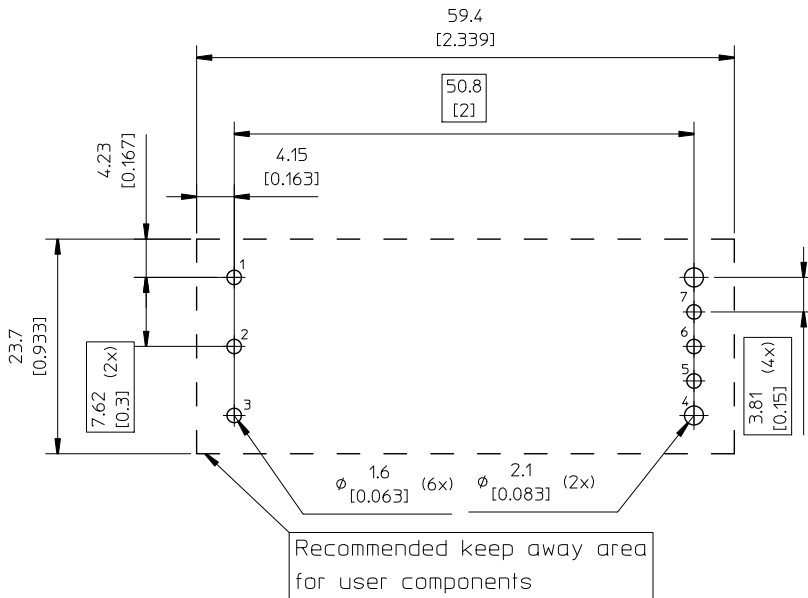
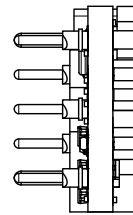

Recommended keep away area  
 for user components

Table 1

Pin option	Lead length
Standard	5.33 [0.21]
LA	3.69 [0.145] (cut)
LB	4.57 [0.18] (cut)

Pins:  
 Material, pins 1-3 & 5-7 : Brass  
 Material, pins 4 & 8 : Copper alloy  
 Plating: 0.1 µm Gold (Au) over 2 µm Nickel (Ni).  
 Weight: typical 21 g

All dimensions in mm [inch].  
 Tolerances unless specified:  
 x.x mm ±0.5 mm [0.02]  
 x.xx mm ±0.25 mm [0.01]  
 (not applied on footprint or typical values)



All component placements – whether shown as physical components or symbolical outline – are for reference only and are subject to change throughout the product's life cycle, unless explicitly described and dimensioned in this drawing.



**D?6 ( \$\$\$5 series Direct Converters**  
 Input 36-72 V, Output up to 30 A / 125 W

EN/LZT 146 420 R4A October 2017

© Flex

**Soldering Information - Surface Mounting**

The surface mount version of the product is intended for convection or vapor phase reflow SnPb and Pb-free processes. To achieve a good and reliable soldering result, make sure to follow the recommendations from the solder paste supplier, to use state-of-the-art reflow equipment and reflow profiling techniques as well as the following guidelines.

A no-clean flux is recommended to avoid entrapment of cleaning fluids in cavities inside the product or between the product and the host board. The cleaning residues may affect long time reliability and isolation voltage.

**Minimum Pin Temperature Recommendations**

Pin number 4 is chosen as reference location for the minimum pin temperature recommendations since this will likely be the coolest solder joint during the reflow process.

Pin 2 for measurement of maximum Peak product reflow temperature,  $T_{PIN}$

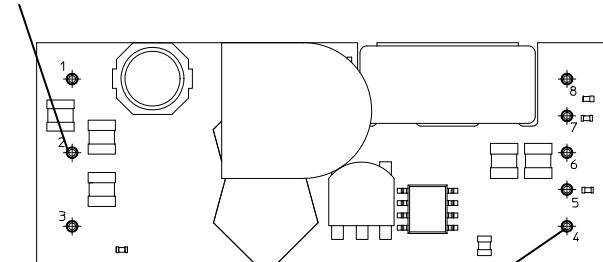

Pin 4 for measurement of minimum Solder joint temperature,  $T_{PIN}$

**SnPb solder processes**

For SnPb solder processes, a pin temperature ( $T_{PIN}$ ) in excess of the solder melting temperature, ( $T_L$ , +183°C for Sn63/Pb37) for more than 30 seconds, and a peak temperature of +210°C is recommended to ensure a reliable solder joint.

**Lead-free (Pb-free) solder processes**

For Pb-free solder processes, a pin temperature ( $T_{PIN}$ ) in excess of the solder melting temperature ( $T_L$ , +217 to +221°C for Sn/Ag/Cu solder alloys) for more than 30 seconds, and a peak temperature of +235°C on all solder joints is recommended to ensure a reliable solder joint.

**Peak Product Temperature Requirements**

Pin number 2 is chosen as reference location for the maximum (peak) allowed product temperature ( $T_p$ ) since this will likely be the warmest part of the product during the reflow process.

To avoid damage or performance degradation of the product, the reflow profile should be optimized to avoid excessive heating. A sufficiently extended preheat time is recommended to ensure an even temperature across the host PCB, for both small and large devices. To reduce the risk of excessive heating is also recommended to reduce the time in the reflow zone as much as possible.

**SnPb solder processes**

For SnPb solder processes, the product is qualified for MSL 1 according to IPC/JEDEC standard J-STD-020C.

During reflow,  $T_p$  must not exceed +225°C at any time.

**Lead-free (Pb-free) solder processes**

For Pb-free solder processes, the product is qualified for MSL 3 according to IPC/JEDEC standard J-STD-020C.

During reflow,  $T_p$  must not exceed +260°C at any time.

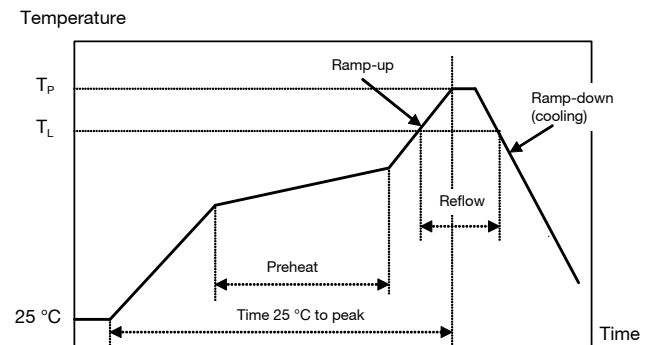

Reflow process specifications		Sn/Pb eutectic	Pb-free
Average ramp-up rate		3°C/s max	3°C/s max
Solder melting temperature (typical)	$T_L$	+183°C	+221°C
Minimum time above $T_L$		30 s	30 s
Minimum pin temperature	$T_{PIN}$	+210°C	+235°C
Peak product temperature	$T_p$	+225°C	+260°C
Average ramp-down rate		6°C/s max	6°C/s max
Time 25°C to peak		6 minutes max	8 minutes max



**D?6 ( \$\$\$5 series Direct Converters**  
 Input 36-72 V, Output up to 30 A / 125 W

EN/LZT 146 420 R4A October 2017

© Flex

**Soldering Information – Through Hole Mounting**

The through hole mount version of the product is intended for manual or wave soldering. When wave soldering is used, the temperature on the pins is specified to maximum 270°C for maximum 10 seconds.

A maximum preheat rate of 4°C/s and a temperature of max +150°C is suggested. When soldering by hand, care should be taken to avoid direct contact between the hot soldering iron tip and the pins for more than a few seconds in order to prevent overheating.

A no-clean flux is recommended to avoid entrapment of cleaning fluids in cavities inside the product or between the product and the host board. The cleaning residues may affect long time reliability and isolation voltage.

**Delivery Package Information, Surface Mount Version**

The surface mount versions of the products are delivered in antistatic injection molded trays (Jedec design guide 4.10D standard).

Tray Specifications	
<b>Material</b>	PPE, Antistatic
<b>Surface resistance</b>	$10^5 < \text{Ohm/square} < 10^{12}$
<b>Bakability</b>	The trays can be baked at maximum 125°C for 48 hours
<b>Tray capacity</b>	20 products/tray
<b>Tray thickness</b>	13.4 mm [0.528 inch]
<b>Box capacity</b>	100 products (5 full trays/box)
<b>Tray weight</b>	110 g empty, 530 g full tray

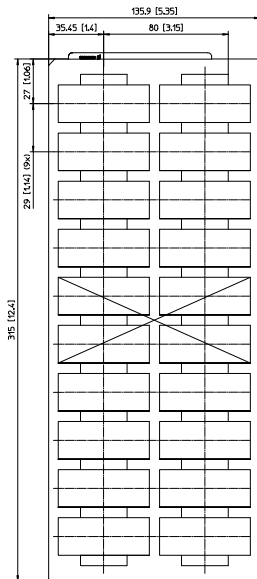

X = Vacuum pickup area.

**Delivery Package Information, Through Hole Mounting Version**

The products are delivered in antistatic clamshell.

Clamshell Specifications	
<b>Material</b>	PET with antistatic coated
<b>Surface resistance</b>	$10^6 < \text{Ohm/square} < 10^{12}$
<b>Bake ability</b>	The clamshells are not bake-able.
<b>Clamshell capacity</b>	20 products/clamshell
<b>Clamshell thickness</b>	20 mm [0.787 inch]
<b>Box capacity</b>	100 products (5 full trays/box)
<b>Clamshell weight</b>	130 g empty, 530 g full tray

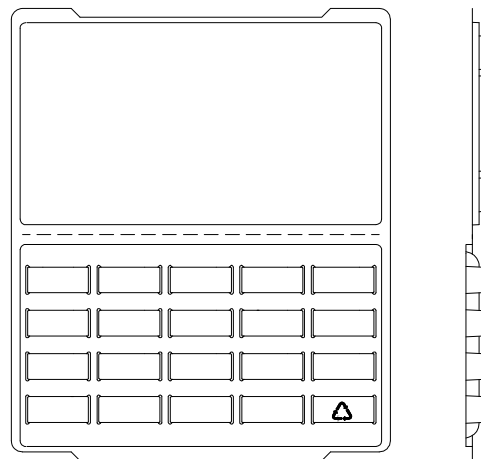

**Non-Dry Pack Information**

The through hole mount version of product is delivered in non-dry packing clamshells.

**Dry Pack Information**

The surface mount versions of the products are delivered in trays. These inner shipment containers are dry packed in standard moisture barrier bags according to IPC/JEDEC standard J-STD-033 (Handling, packing, shipping and use of moisture/reflow sensitivity surface mount devices).

Using products in high temperature Pb-free soldering processes requires dry pack storage and handling. In case the products have been stored in an uncontrolled environment and no longer can be considered dry, the modules must be baked according to J-STD-033.



**D?6 ( \$\$\$5 series Direct Converters**  
Input 36-72 V, Output up to 30 A / 125 W

EN/LZT 146 420 R4A October 2017

© Flex

### Product Qualification Specification

Characteristics			
External visual inspection	IPC-A-610		
Change of temperature (Temperature cycling)	IEC 60068-2-14 Na	Temperature range Number of cycles Dwell/transfer time	-40 to +100°C 1000 15 min/0-1 min
Cold (in operation)	IEC 60068-2-1 Ad	Temperature T <sub>A</sub> Duration	-45°C 72 h
Damp heat	IEC 60068-2-67 Cy	Temperature Humidity Duration	+85°C 85 % RH 1000 hours
Dry heat	IEC 60068-2-2 Bd	Temperature Duration	+125°C 1000 h
Electrostatic discharge susceptibility	IEC 61340-3-1, JESD 22-A114 IEC 61340-3-2, JESD 22-A115	Human body model (HBM) Machine Model (MM)	Class 2, 2000 V Class 3, 200 V
Immersion in cleaning solvents	IEC 60068-2-45 XA Method 2	Water Glycol ether Isopropyl alcohol	+55°C +35°C +35°C
Mechanical shock	IEC 60068-2-27 Ea	Peak acceleration Duration	100 g 6 ms
Moisture reflow sensitivity <sup>1</sup>	J-STD-020C	Level 1 (SnPb-eutectic) Level 3 (Pb Free)	225°C 260°C
Operational life test	MIL-STD-202G method 108A	Duration	1000 h
Resistance to soldering heat <sup>2</sup>	IEC 60068-2-20 Tb Method 1A	Solder temperature Duration	270°C 10-13 s
Robustness of terminations	IEC 60068-2-21 Test Ua1 IEC 60068-2-21 Test Ue1	Through hole mount products Surface mount products	All leads All leads
Solderability	IEC 60068-2-58 test Td <sup>1</sup>	Preconditioning Temperature, SnPb Eutectic Temperature, Pb-free	150°C dry bake 16 h 215°C 235°C
	IEC 60068-2-20 test Ta <sup>2</sup>	Preconditioning Temperature, SnPb Eutectic Temperature, Pb-free	Steam ageing 235°C 245°C
Vibration, broad band random	IEC 60068-2-64 Fh, method 1	Frequency Spectral density Duration	10 to 500 Hz 0.07 g <sup>2</sup> /Hz 10 min in each perpendicular direction

Note 1: Only for products intended for reflow soldering (surface mount products)

Note 2: Only for products intended for wave soldering (plated through hole products)

## OUR CERTIFICATE

DiGi provide top-quality products and perfect service for customer worldwide through standardization, technological innovation and continuous improvement. DiGi through third-party certification, we stricy control the quality of products and services. Welcome your RFQ to

Email: [Info@DiGi-Electronics.com](mailto:Info@DiGi-Electronics.com)



Tel: +00 852-30501935

RFQ Email: [Info@DiGi-Electronics.com](mailto:Info@DiGi-Electronics.com)

DiGi is a global authorized distributor of electronic components.